



SORTIMENTSÜBERSICHT FLIESEN

TILE RANGES

2023



Villeroy & Boch

1748

CONTENTS

General information 4

Product groups / Slip resistance	4	VilboStone / VilbostonePlus / VilboTouch	12
Ranges by format	6	CeramicPlus / PowderTouch / Concept ³	13
Advantages of ceramic tiles	10	Calculation aids	16

Living 18

Atlanta	20	Melrose	46	Ombra <i>Excellence</i>	79	Stageart	109
Back Home	25	Merida <i>Excellence</i>	47	Pier 45	80	Talk about	111
Bellagio <i>Excellence</i>	27	Metalyn	50	Pure Base	84	Townhouse	111
Bernina	28	Metro Flair	61	Restonica	88	Urban Art	113
Bourgogna	29	My Earth	61	Rocky.Art	89	Urban Jungle	114
Cádiz <i>Excellence</i>	33	Natural Blend <i>Excellence</i>	65	Section	93	Urbantones <i>Excellence</i>	122
Houston	35	Nocturne <i>Excellence</i>	67	Silent Mood	94	Victorian <i>Excellence</i>	123
Lucca	36	Northfield	72	Soft Colours	96	White & Cream	126
Marble Arch <i>Excellence</i>	38	Oak Park	73	Sparks <i>Excellence</i>	98	Workshop <i>Excellence</i>	128
Marmochic <i>Excellence</i>	41	Oak Side	76	Spotlight <i>Excellence</i>	100		

Architecture 130

Aberdeen	132	Lobby	157	Pure Line 2.0	192	Unit Four	214
Code 2	138	Ohio	158	Solid Tones	198	Unit Four Wall	218
Daytona	143	Pro Architectura 3.0	160	Unit One	204	X-Plane	219
Édition C	143	Pro Architectura 3.0		Unit Two	207		
Hudson	146	Pool System	182	Unit Three	210		

OPTIMA 226

VILBOGARDEN 232

Cádiz GARDEN	234	Oak Line GARDEN	242
Lucca GARDEN	235	Oak Park GARDEN	243
Memphis GARDEN	236	Urban Jungle GARDEN	244
Mont Blanc GARDEN	238	Functional trims	245
My Earth GARDEN	240		

Technical information 248

Slip resistance	250	UPEC – Classification / WalIPEC – Classification	274
Tribometer testing	264	Colour codes / Shade variation / LRV	276
The pendulum testing	266	Colour codes	278
Wear resistance	270	General information	282

General Conditions of Sale 291

Index 294

INHALTSVERZEICHNIS

Allgemeine Informationen 4

Erzeugnisgruppen / Rutschhemmung	4	VilboStone / VilbostonePlus / VilboTouch	14
Serien nach Formaten	6	CeramicPlus / PowderTouch / Concept³	15
Vorteile keramischer Fliesen	11	Kalkulationshilfen	16

Wohnen 18

Atlanta	20	Melrose	46	Ombra <i>Excellence</i>	79	Stageart	109
Back Home	25	Merida <i>Excellence</i>	47	Pier 45	80	Talk about	111
Bellagio <i>Excellence</i>	27	Metalyn	50	Pure Base	84	Townhouse	111
Bernina	28	Metro Flair	61	Restonica	88	Urban Art	113
Bourgogna	29	My Earth	61	Rocky.Art	89	Urban Jungle	114
Cádiz <i>Excellence</i>	33	Natural Blend <i>Excellence</i>	65	Section	93	Urbantones <i>Excellence</i>	122
Houston	35	Nocturne <i>Excellence</i>	67	Silent Mood	94	Victorian <i>Excellence</i>	123
Lucca	36	Northfield	72	Soft Colours	96	White & Cream	126
Marble Arch <i>Excellence</i>	38	Oak Park	73	Sparks <i>Excellence</i>	98	Workshop <i>Excellence</i>	128
Marmochic <i>Excellence</i>	41	Oak Side	76	Spotlight <i>Excellence</i>	100		

Architektur 130

Aberdeen	132	Lobby	157	Pure Line 2.0	192	Unit Four	214
Code 2	138	Ohio	158	Solid Tones	198	Unit Four Wall	218
Daytona	143	Pro Architectura 3.0	160	Unit One	204	X-Plane	219
Édition C	143	Pro Architectura 3.0		Unit Two	207		
Hudson	146	Pool System	182	Unit Three	210		

OPTIMA 226

VILBOGARDEN 232

Cádiz GARDEN	234	Oak Line GARDEN	242
Lucca GARDEN	235	Oak Park GARDEN	243
Memphis GARDEN	236	Urban Jungle GARDEN	244
Mont Blanc GARDEN	238	Formteile	245
My Earth GARDEN	240		

Technische Informationen 248

Trittsicherheit / Rutschhemmung	251	UPEC – Klassifizierung / WalIPEC – Klassifizierung	275
Tribometer-Prüfung	265	Variationsvielfalt / Farbcodierungen / LRV	277
Pendelprüfung	267	Farbcodierungen	278
Abrieb / Verschleiß	271	Allgemeines	285

Allgemeine Verkaufsbedingungen 291

Suchverzeichnisse 294

PRODUCT GROUPS | SLIP RESISTANCE

Serien Ranges	Steingut Nonvitreous	Steinzeug glasiert Glazed vitreous	Feinsteinzeug Porcelain stoneware	Feinsteinzeug glasiert Glazed porcelain stoneware	R9	R10	R11	R12	R13	R12 V4	A	B	C
	Erzeugnisgruppe Product group				Rutschhemmung Slip resistance								
Aberdeen	X		X			X	X			X	X	X	X
Atlanta	X		X	X		X						X	
Back Home	X		X	X		X					X	X	
Bellagio	X		X		X								
Bernina			X		X	X					X		
Bourgogna			X			X						X	
Cádiz	X		X			X					X		
Code 2			X			X					X		
Daytona			X	X		X						X	
Édition C	X												
Houston	X												
Hudson			X		X	X	X				X	X	X
Lobby			X	X		X					X	X	
Lucca			X	X	X	X						X	
Marble Arch	X		X	X	X						X		
Marmochic	X			X	X						X		
Melrose	X												
Merida	X		X			X						X	
Metalyn	X		X	X	X	X						X	
Metro Flair	X												
My Earth			X		X		X					X	
Natural Blend	X		X		X	X					X	X	
Nocturne				X									
Northfield			X			X					X	X	
Oak Park			X			X					X		
Oak Side	X		X			X					X	X	
Ohio	X		X		X	X						X	
Ombra	X												
Pier 45			X	X		X						X	
Pro Architectura 3.0	X	X	X		X	X	X	X		X	X	X	X
Pro Architectura 3.0 Pool System		X											X
Pure Base			X	X	X	X						X	

This is a very general allocation of ranges to product groups and slip resistance. Individual articles may vary slightly. Exact information is provided in the details for each article.

ERZEUGNISGRUPPEN | RUTSCHHEMMUNG

Serien Ranges	Steingut Nonvitreous	Steinzeug glasiert Glazed vitreous	Feinsteinzeug Porcelain stoneware	Feinsteinzeug glasiert Glazed porcelain stoneware	R9	R10	R11	R12	R13	R12 V4	A	B	C
	Erzeugnisgruppe Product group				Rutschhemmung Slip resistance								
Pure Line 2.0			X			X						X	
Restonica	X												
Rocky.Art	X		X	X		X						X	
Silent Mood	X												
Section			X		X	X						X	
Soft Colours	X												
SollidTones			X			X	X					X	X
Sparks			X			X					X		
Spotlight	X		X	X	X						X		
Stageart	X		X			X						X	
Talk about	X												
Townhouse	X			X	X						X		
Unit One		X	X		X	X					X	X	
Unit Two	X												
Unit Three			X		X	X	X	X	X	X	X	X	
Unit Four			X	X		X					X	X	
Unit Four Wall	X			X		X						X	
Urban Art				X									
Urban Jungle	X		X		X						X		
Urbantones	X			X	X						X		
Victorian	X												
White & Cream	X												
Workshop	X		X		X						X		
X-Plane			X			X	X					X	
Cádiz GARDEN			X				X					X	
Lucca GARDEN			X				X					X	
Memphis GARDEN			X				X					X	
Mont Blanc GARDEN			X				X					X	
My Earth GARDEN			X				X					X	
Oak Line GARDEN			X				X					X	
Oak Park GARDEN			X				X					X	
Urban Jungle GARDEN			X				X					X	

Dies ist eine pauschale Einordnung der Serien zu Erzeugnisgruppen und Rutschhemmung. Einzelne Artikel können davon abweichen. Genaue Informationen finden sich in den Angaben pro Artikel.

RANGES BY FORMAT

Serien Ranges	1,7 x 60	2,5 x 2,5	2,5 x 15	3,5 x 3,5	3,7 x 3,7	3,3 x 7,5	4,5 x 10	5 x 5	5 x 10	5 x 60	6 x 25	7,5 x 7,5	7,5 x 40	7,5 x 60	10 x 10	10 x 20	10 x 30	10 x 60	10 x 120	12,5 x 12,5	12,5 x 40	13 x 15	15 x 15	15 x 20	15 x 30
Aberdeen			X									X		X											
Atlanta												X													
Back Home								X																	
Bernina						X								X											
Bellagio							X																		
Bourgogna												X													
Cádiz								X								X									
Code 2												X													
Daytona							X																		
Édition C																									
Houston																									
Hudson			X									X		X											
Lobby								X																	
Lucca												X													
Marble Arch					X		X											X	X						
Marmochic				X	X																				
Melrose																									
Merida								X																	
Metalyn	X											X													
Metro Flair															X	X									
My Earth						X												X							
Natural Blend	X							X																	
Nocturne																									
Northfield								X																	
Oak Park			X										X												
Oak Side								X																	
Ohio																									
Ombra																									
Pier 45								X															X		
Pro Architectura 3.0		X						X							X	X	X							X	
Pure Base																									
Pure Line 2.0												X		X											
Restonica																									
Rocky.Art												X													
Section								X																	
Silent Mood																									
Soft Colours																									
Solid Tones										X					X										
Sparks																									
Spotlight			X					X																	

SERIEN NACH FORMATEN

Serien Ranges	15 x 60	20 x 20	20 x 25	20 x 40	20 x 60	20 x 120	25 x 40	25 x 50	26 x 34,5	30 x 30	30 x 49	30 x 50	30 x 60	30 x 90	30 x 120	33 x 99	40 x 80	40 x 120	45 x 45	60 x 60	60 x 120	80 x 80	120 x 120	120 x 260
Aberdeen										X			X		X	X				X	X			
Atlanta											X		X			X				X	X	X		
Back Home					X								X						X	X				
Bernina	X											X	X							X				
Bellagio										X			X							X				
Bourgogna									X											X	X	X		
Cádiz													X	X						X				
Code 2						X														X	X	X		
Daytona													X											
Édition C				X																				
Houston													X											
Hudson	X									X			X		X					X	X		X	X
Lobby													X											
Lucca	X												X						X	X	X			
Marble Arch						X												X		X	X			
Marmochic													X					X		X	X			
Melrose													X											
Merida													X					X		X	X			
Metalyn													X		X			X	X	X	X	X	X	X
Metro Flair																								
My Earth					X					X			X							X				
Natural Blend													X		X			X		X	X			
Nocturne																				X	X		X	X
Northfield													X							X				
Oak Park						X									X									
Oak Side						X								X	X									
Ohio													X						X	X				
Ombra														X										
Pier 45																				X	X	X		
Pro Architectura 3.0		X			X					X			X							X				
Pure Base													X						X	X		X		
Pure Line 2.0	X												X		X					X	X		X	
Restonica					X																			
Rocky.Art					X								X		X				X	X	X			
Section													X							X				
Silent Mood													X											
Soft Colours													X			X								
Solid Tones					X					X			X		X					X	X			
Sparks																							X	
Spotlight						X							X					X	X	X		X	X	X

RANGES BY FORMAT

Serien Ranges	1,7 x 60	2,5 x 2,5	2,5 x 15	3,5 x 3,5	3,7 x 3,7	3,3 x 7,5	4,5 x 10	5 x 5	5 x 10	5 x 60	6 x 25	7,5 x 7,5	7,5 x 40	7,5 x 60	10 x 10	10 x 20	10 x 30	10 x 60	10 x 120	12,5 x 12,5	12,5 x 40	13 x 15	15 x 15	15 x 20	15 x 30
Stageart												X													
Talk about																									
Townhouse												X						X							
Unit One								X							X	X	X						X		
Unit Two																							X	X	X
Unit Three															X								X		
Unit Four								X																	
Unit Four Wall								X																	
Urban Art											X				X										
Urban Jungle												X													
Urbantones																		X							
Victorian					X							X	X								X	X			
White & Cream																									
Workshop												X													
X-Plane			X									X	X												
Cádiz GARDEN																									
Lucca GARDEN																									
Memphis GARDEN																									
Mont Blanc GARDEN																									
My Earth GARDEN																									
Oak Line GARDEN																									
Oak Park GARDEN																									
Urban Jungle GARDEN																									

SERIEN NACH FORMATEN

Serien Ranges	15 x 60	20 x 20	20 x 25	20 x 40	20 x 60	20 x 120	25 x 40	25 x 50	26 x 34,5	30 x 30	30 x 49	30 x 50	30 x 60	30 x 90	30 x 120	33 x 99	40 x 80	40 x 120	45 x 45	60 x 60	60 x 120	80 x 80	120 x 120	120 x 260
Stageart													X							X				
Talk about													X											
Townhouse					X								X							X				
Unit One		X								X			X											
Unit Two		X	X	X	X		X	X					X											
Unit Three		X								X			X											
Unit Four										X			X							X				
Unit Four Wall				X	X								X											
Urban Art																								
Urban Jungle													X					X	X	X		X	X	X
Urbantones																								
Victorian		X																X		X				
White & Cream							X	X					X	X										
Workshop													X					X		X				
X-Plane	X									X			X		X					X	X			
Cádiz GARDEN																	X			X				
Lucca GARDEN																				X		X		
Memphis GARDEN																				X		X		
Mont Blanc GARDEN																				X		X		
My Earth GARDEN																	X			X		X		
Oak Line GARDEN																		X						
Oak Park GARDEN																		X						
Urban Jungle GARDEN																						X		

ADVANTAGES OF CERAMIC TILES

Ceramic is a fascinating and inspiring material that has been popular for thousands of years and that is increasingly used in modern interior design. Hardly any other housing material combines so many positive properties at the same time as providing

inspiration for countless creative living ideas for a beautiful home. Tiles from Villeroy & Boch meet high technical and aesthetic standards and offer advantages in terms of a healthy home environment and energy savings.



Good for health

Ceramic tiles are simply ideal for a healthy living environment. Whether glazed or unglazed, their surfaces are highly impervious. Mites and other microorganisms that cause a large number of allergies don't stand a chance. Ceramic itself does not give off any vapours or smells and, for this reason, is also recommended in terms of building biology.



Environmentally-friendly and natural

The high quality of Villeroy & Boch tiles in terms of both workmanship and product concept ensures the necessary durability and sustainability. They are made of natural components that occur naturally in almost unlimited quantities. They are also manufactured by means of environment-friendly processes and a large proportion of the production waste is recycled. Tiles can also be disposed of in an environmentally safe manner.



Energy-efficiency saves costs

For underfloor heating there is no better covering than ceramic, which boasts good thermal conductivity and heat storage capacity and is also anti-static. A pleasant and efficient side effect: on hot summer days, tiles also help to keep things cool.



Easy care

Tiles are naturally hygienic and easy to clean. The cleaning methods and cleaning agents must thus be adapted to the type of floor and local conditions.



Barrier-free living and design

Today, bathrooms in particular should not have any unnecessary thresholds. Tiles and mosaics are perfect for barrier-free, walk-in and wheelchair-friendly showers and baths. Provided with non-slip surfaces, tiles also ensure a secure footing.



Colour-fastness

Tiles are colour- and lightfast and their appearance will not even be affected by exposure to direct sunlight.



Safety underfoot

Frost- and weather-resistant VilboStone porcelain stoneware tiles make ideal floor coverings for both indoors and outdoors. It is precisely here that the non-slip properties of tiles come into their own, offering a secure foothold, even when it's wet.



Their good looks are undiminished over time

Tiles from Villeroy & Boch are durable and do not wear down, even after decades of use. They are largely scratch- and crack-resistant. Falling embers from open fires, stoves or cigarettes that will cause lasting damage to other floor coverings can be removed without a trace from tiles.



Frost resistance

VilboStone porcelain stoneware tiles are frost-proof and weather-resistant when laid professionally and therefore also suitable for use in outdoor areas.



Aesthetic selection available to cover all tastes

There are an unlimited number of colours, designs and finishes. As design media, they offer solutions for every style and taste. Tiles cannot be considered in isolation here, but form an integral part of the overall design scenario and are of crucial importance to the room concept and a harmonious interior.

VORTEILE KERAMISCHER FLIESEN

Seit Jahrtausenden beliebt und für die moderne Inneneinrichtung immer wichtiger: Keramik, ein Material, das fasziniert und inspiriert. Es gibt kaum ein Wohnmaterial, das so viele positive Eigenschaften in sich vereint und gleichzeitig zu unzähligen

kreativen Wohnideen für ein schönes Zuhause anregt. Fliesen von Villeroy & Boch sind technisch und ästhetisch hochwertige Produkte mit wohngesunden und energiesparenden Vorteilen.



Gut für Ihre Gesundheit

Keramische Fliesen sind für ein gesundes Wohnen geradezu prädestiniert. Ihre glasierten oder unglasierten Oberflächen sind sehr dicht. Milben und andere Mikroorganismen, die für sehr viele Allergien verantwortlich sind, haben kaum eine Überlebenschance. Keramik selbst dünst keine Schadstoffe aus, ist geruchsneutral und ist daher baubiologisch empfehlenswert.



Umweltverträglich und natürlich

Fliesen von Villeroy & Boch sind aufgrund ihrer qualitativen und konzeptionellen Hochwertigkeit langlebig und nachhaltig. Sie bestehen aus natürlichen Bestandteilen, die in der Natur nahezu unbegrenzt vorhanden sind. Zudem werden sie mit umweltschonenden Verfahren hergestellt und entstehende Abfälle im Produktionskreislauf werden zu einem großen Teil einer Wiederverwertung zugeführt. Ebenso können Fliesen umweltgerecht entsorgt werden.



Energieeffizienz spart Kosten

Für Fußbodenheizungen gibt es keinen besseren Belag als Keramik, die eine gute Wärmeleit- und Speicherfähigkeit besitzt und zudem antistatisch ist. Ein angenehmer und effizienter Zusatzeffekt: Im heißen Sommer wirken Fliesen Temperatur ausgleichend.



Vereinfachte Pflege

Fliesen sind von Natur aus hygienisch und leicht zu reinigen. Reinigungsverfahren und Reinigungsmittel sollten daher auf den jeweiligen Fliesenbelag und die örtlichen Verhältnisse abgestimmt werden.



Barrierefrei wohnen und gestalten

Gerade Bäder sollten heute keine unnötigen Schwellen aufweisen. Auch hier sind Fliesen und Mosaik perfekt für barrierefrei begehbare und befahrbare Duschen und Bäder. Ausgestattet mit rutschhemmenden Oberflächen sind Fliesen zudem eine sichere Grundlage.



Farbechtheit

Fliesen sind dauerhaft farb- und lichtecht und verändern auch durch direkte Sonneneinstrahlung nicht ihr Aussehen.



Sicherheit auf Schritt und Tritt

Frost- und witterungsbeständige VilboStone Feinsteinzeugfliesen sind ideale Bodenbeläge sowohl für den Innen- als auch für den Außenbereich. Gerade hier bewähren sich die rutschhemmenden Eigenschaften von Fliesen, die auch bei Nässe einen sicheren Auftritt geben.



Noch in Jahrzehnten schön wie am ersten Tag

Fliesen von Villeroy & Boch sind strapazierfähig und druckbeständig und nutzen sich auch durch jahrzehntelangen Gebrauch nicht ab. Denn sie sind in hohem Maße kratz- und ritzfest. Ebenso hinterlassen herabgefallene Glut von Kaminen, Öfen oder Zigaretten, die auf anderen Bodenbelägen bleibende Schäden anrichten, auf Fliesen keine Spuren.



Frostbeständigkeit

VilboStone Feinsteinzeugfliesen sind bei fachgerechter Verlegung frost- und witterungsbeständig und eignen sich somit auch für die Verlegung im Außenbereich.



Ästhetische Vielfalt für jeden Geschmack

Die Vielfalt der Farben, Designs und Oberflächen ist unbegrenzt. Als Gestaltungsmittel gibt es Lösungen für jeden Stil und Geschmack. Dabei können Fliesen nicht isoliert betrachtet werden, sondern sind ein integrierter Bestandteil des Gestaltungsumfeldes und für das Raumkonzept und die Raumharmonie von entscheidender Bedeutung.

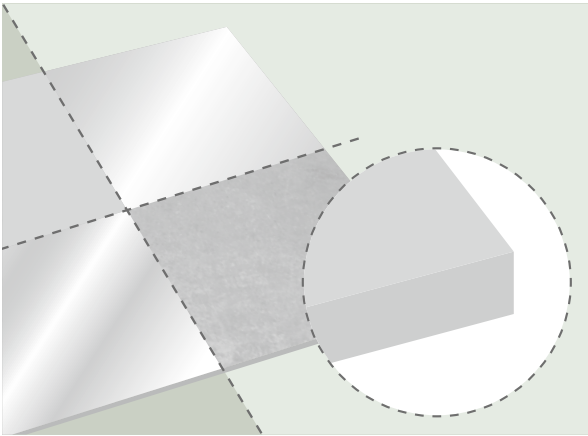

Versatile and functional

VilboStone

VilboStone porcelain stoneware permits a wealth of different surface designs featuring unusual colour and sheen effects.

VilboStone porcelain stoneware is available both glazed and unglazed, with a matt, polished, rough-polished or relief surface finish and in various classes of slip resistance. Tiles of this quality are resistant to chemicals, colour- and light-fast and feature impressive with highly resistant properties for indoor and outdoor areas.

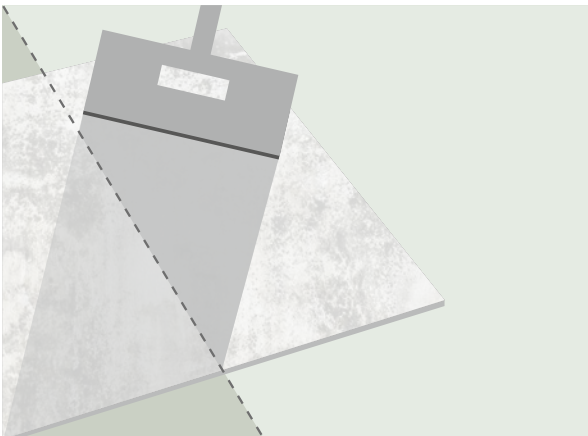

Insusceptible to staining and soiling

VilbostonePlus

During the manufacturing process for coloured porcelain stoneware, the unglazed ceramic is provided with the **VilbostonePlus** finish, markedly reducing the tiles' susceptibility to staining and soiling. The porcelain stoneware produced with **VilbostonePlus** ensures high resistance to mechanical strain, chemicals, wear and abrasion and is particularly easy-care.

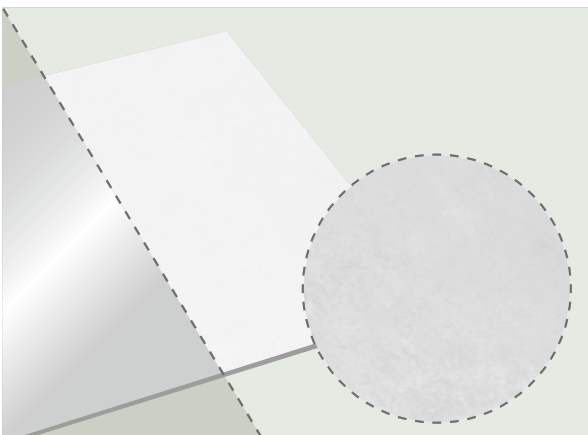

Slip-resistant and easy-care

VilboTouch

VilboTouch, a new surface finish with a soft look, created as a symbiosis of aesthetic appeal and technical functionality. The microscopically fine structure ensures that the tiles comply with slip-resistance class R10 while also providing for an easy-care finish.

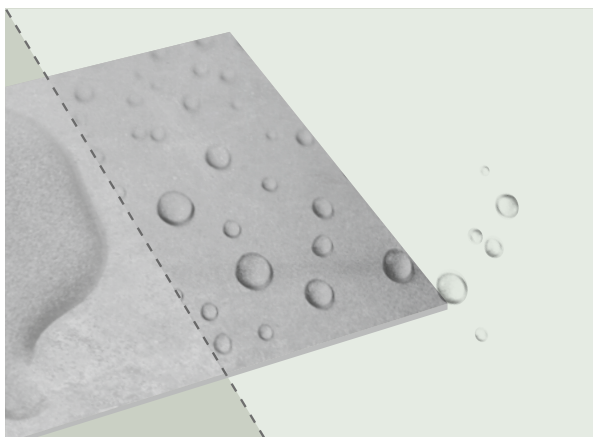

Easy to clean and hygienic

CeramicPlus

The nonvitreous wall tiles are manufactured with **CeramicPlus**, a surface finish offering lasting easy-care properties. Impurities and dirt roll off of this dirt-resistant surface in large beads, with little chance of adhering to the tiles. Cleaning often calls for nothing more than water and a cloth, making aggressive cleaning agents unnecessary.

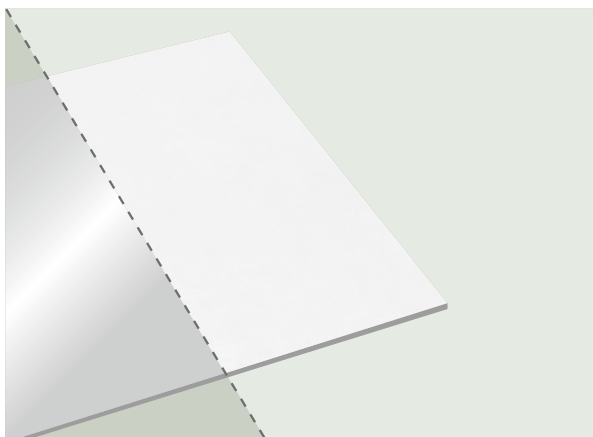

Soft and ultra-matt

PowderTouch

Innovative matt-finish glaze for nonvitreous tiles. This glaze gives wall tiles an ultra-matt surface finish with a powdery soft feel and makes colours look exquisite and modern.

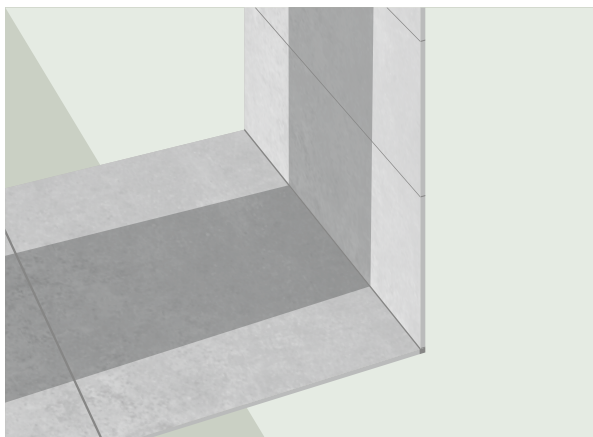

Perfectly matched wall and floor coverings

Concept³

The **Concept³** ranges are sophisticated wall and floor concepts in which everything matches, down to the smallest detail: the colours, formats, designs and decorations of the nonvitreous wall tiles and of the high-quality floor tiles made of **VilboStone** porcelain stoneware match up so perfectly that they permit seamless aesthetic interior designs – very individual and always stylish.

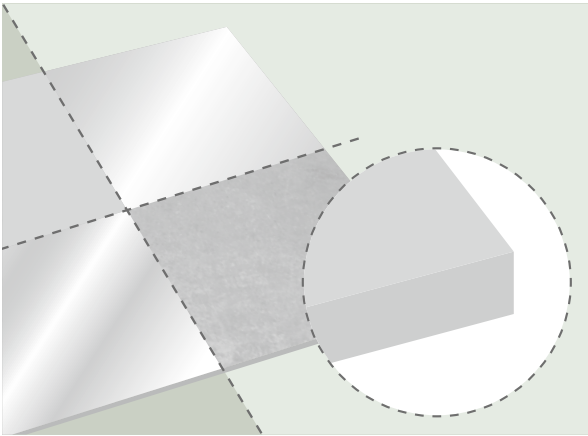

Vielfältig und funktional

VilboStone

VilboStone Feinsteinzeug ermöglicht eine Vielzahl unterschiedlicher Oberflächen-Designs mit außergewöhnlichen Farb- und Glanzeffekten. Erhältlich ist **VilboStone** Feinsteinzeug als unglasiertes und glasiertes Material mit matten, polierten, anpolierten sowie reliefierten Oberflächen und mit unterschiedlichen Rutschhemmungen. Fliesen dieser Güte sind chemikalienbeständig, farb- und lichtecht und überzeugen mit hoch widerstandsfähigen Eigenschaften in Innen- und Außenbereichen.

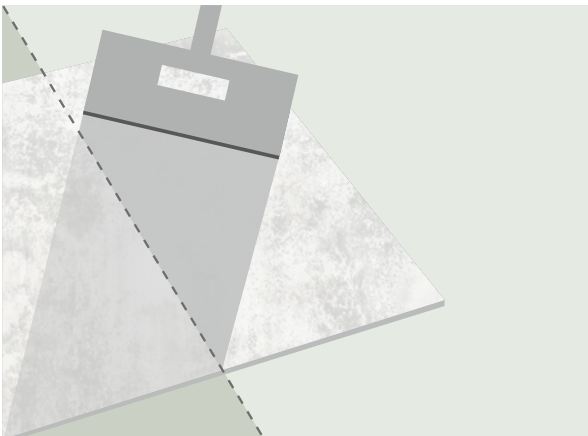

Fleck – und Schmutzunempfindlich

VilbostonePlus

Bereits im Herstellungsprozess wird bei eingefärbtem Feinsteinzeug die unglasierte Keramik mit der **VilbostonePlus**-Ausrüstung versehen, die die Fleck- und Schmutzempfindlichkeit deutlich reduziert. Das mit **VilbostonePlus** hergestellte Feinsteinzeug gewährleistet eine hohe Beständigkeit gegenüber mechanischer Beanspruchung, Chemikalien, Verschleiß und Abrieb und ist besonders pflegeleicht.

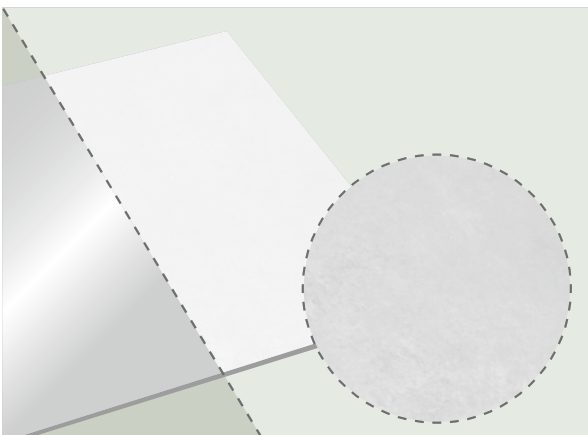

Rutschhemmend und pflegeleicht

VilboTouch

VilboTouch, ein neues weich anmutendes Oberflächenfinish, geschaffen als Symbiose aus Ästhetik und Technik. Die mikroskopisch feine Struktur sorgt dafür, dass die Fliesen die Trittsicherheitsklasse R10 erfüllen und sich gleichzeitig durch besondere Pflegeleichtigkeit auszeichnen.

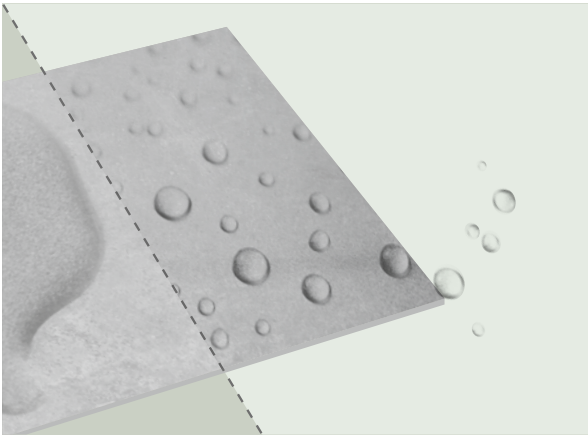

Reinigungsfreundlich und hygienisch

CeramicPlus

Die Wandfliesen aus Steingut sind werkseitig mit der dauerhaft pflegeleichten Oberflächenveredelung **CeramicPlus** ausgestattet. Verunreinigungen und Schmutz perlen auf dieser schmutzabweisenden Oberfläche in großen Tropfen ab und haben kaum eine Chance, sich festzusetzen. Zur Reinigung genügen oft nur Wasser und ein Tuch, aggressive Reiniger werden überflüssig.

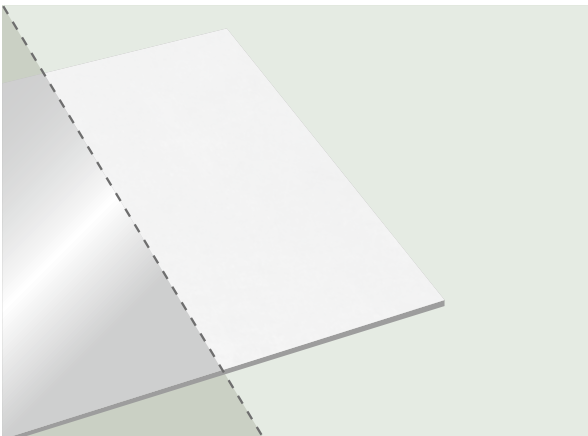

Sanft und ultramatt

PowderTouch

Innovative Matt-Finish-Glasur für Fliesen aus Steingut. Die Glasur verleiht den Wandfliesen eine ultramatte Oberflächenanmutung mit einer pudrig-sanften Haptik und lässt die Farben edel und modern wirken.

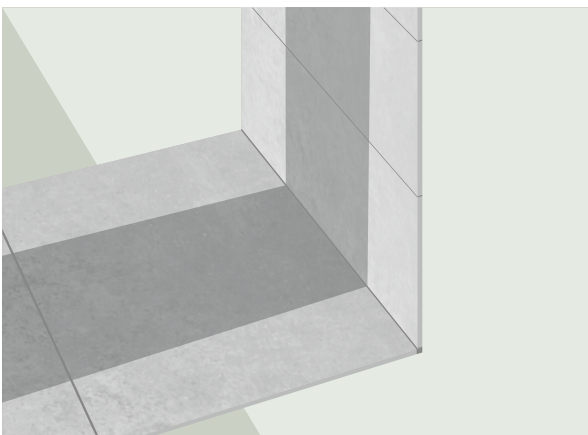

Perfekt aufeinander abgestimmte
Wand- und Bodenbeläge

Concept³

Die **Concept³**-Serien sind durchdachte Wand- und Bodenkonzepte, bei denen alles bis ins kleinste Detail zusammenpasst: Die Farben, Formate, Designs und Dekorationen der Wandfliesen aus Steingut und hochwertigen Bodenfliesen aus **VilboStone** Feinsteinzeug sind so perfekt aufeinander abgestimmt, dass sie ästhetische Raumgestaltungen wie aus einem Guss ermöglichen – ganz individuell und dabei immer stilsicher.

CALCULATION AIDS

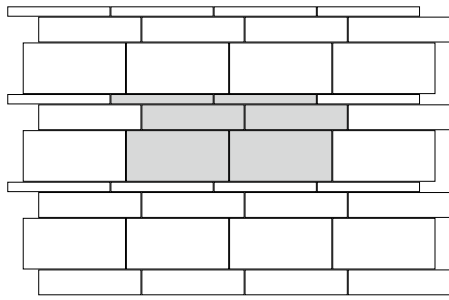

Format (cm) Size* (cm)	Prozent (%) Percent (%)
30 x 60	57,14
15 x 60	28,57
7,5 x 60	14,29

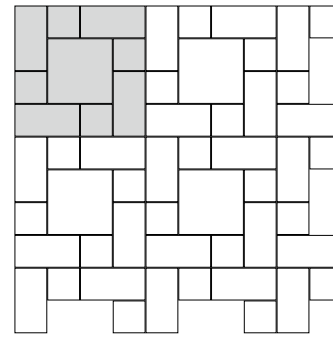

Format (cm) Size* (cm)	Prozent (%) Percent (%)
60 x 60	25,00
30 x 60	50,00
30 x 30	25,00

Format (cm) Size* (cm)	Prozent (%) Percent (%)
20 x 20	25,00
10 x 20	50,00
10 x 10	25,00

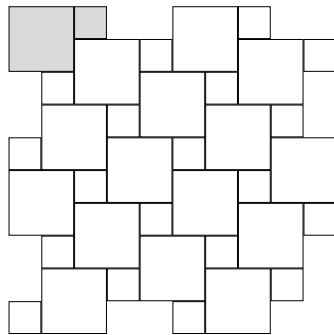

Format (cm) Size* (cm)	Prozent (%) Percent (%)
60 x 60	80,00
30 x 30	20,00

Format (cm) Size* (cm)	Prozent (%) Percent (%)
20 x 20	80,00
10 x 10	20,00

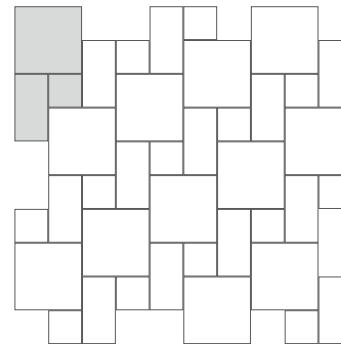

Format (cm) Size* (cm)	Prozent (%) Percent (%)
60 x 60	57,14
30 x 60	28,57
30 x 30	14,29

Format (cm) Size* (cm)	Prozent (%) Percent (%)
20 x 20	57,14
10 x 20	28,57
10 x 10	14,29

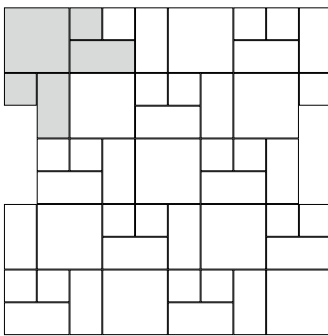

Format (cm) Size* (cm)	Prozent (%) Percent (%)
60 x 60	40,00
30 x 60	40,00
30 x 30	20,00

Format (cm) Size* (cm)	Prozent (%) Percent (%)
20 x 20	40,00
10 x 20	40,00
10 x 10	20,00

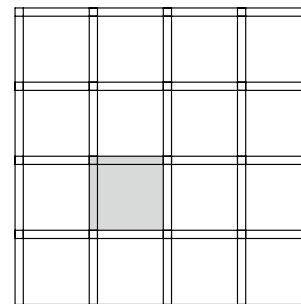

Format (cm) Size* (cm)	Prozent (%) Percent (%)
60 x 60	79,01
7,5 x 60	19,75
7,5 x 7,5	1,24

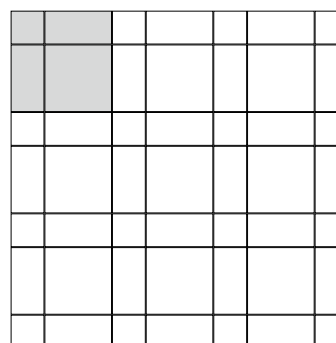

Format (cm) Size* (cm)	Prozent (%) Percent (%)
60 x 60	44,44
30 x 60	44,44
30 x 30	11,12

Format (cm) Size* (cm)	Prozent (%) Percent (%)
20 x 20	44,44
10 x 20	44,44
10 x 10	11,12

KALKULATIONSHILFEN

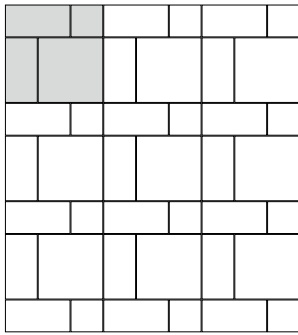

Format (cm)	Prozent (%)
Size* (cm)	Percent (%)
60 x 60	44,44
30 x 60	44,44
30 x 30	11,12

Format (cm)	Prozent (%)
Size* (cm)	Percent (%)
20 x 20	44,44
10 x 20	44,44
10 x 10	11,12

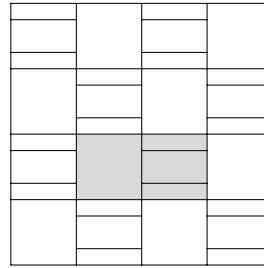

Format (cm)	Prozent (%)
Size* (cm)	Percent (%)
60 x 60	50,00
30 x 60	25,00
15 x 60	25,00

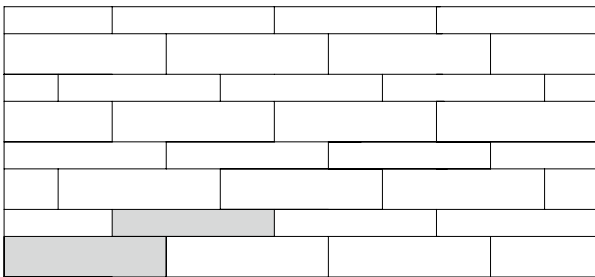

Format (cm)	Prozent (%)
Size* (cm)	Percent (%)
20 x 120	40
30 x 120	60

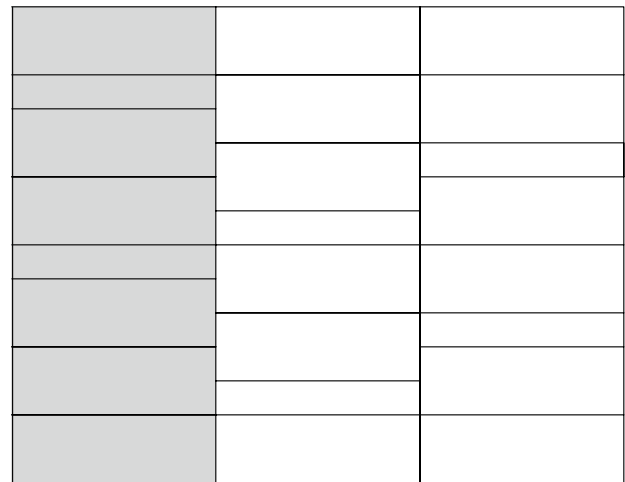

Format (cm)	Prozent (%)
Size* (cm)	Percent (%)
40 x 120	85,71
20 x 120	14,29

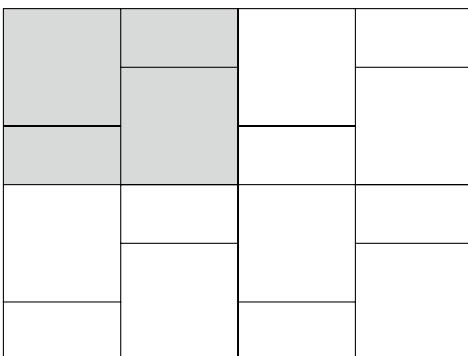

Format (cm)	Prozent (%)
Size* (cm)	Percent (%)
80 x 80	66,67
40 x 80	33,33

Format (cm)	Prozent (%)
Size* (cm)	Percent (%)
60 x 60	66,67
30 x 60	33,33

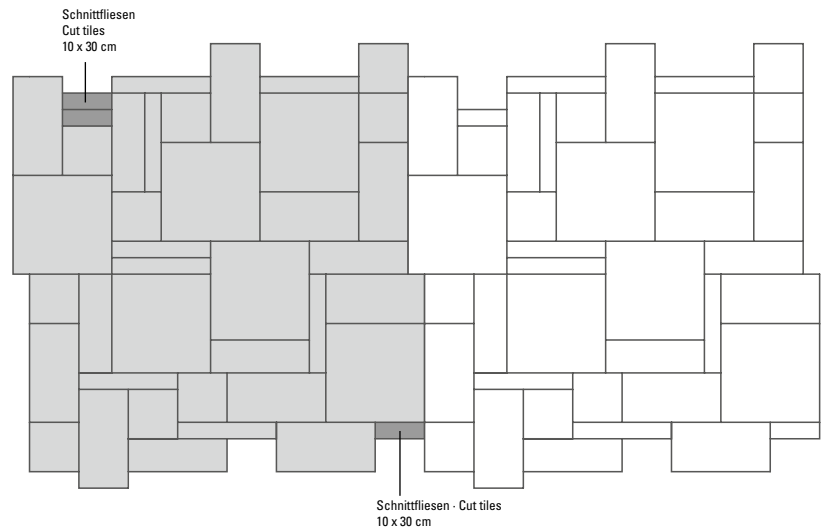

Format (cm)	Prozent (%)
Size* (cm)	Percent (%)
30 x 30	19,00
30 x 60	29,00
60 x 60	37,50
20 x 60	10,50
10 x 60	8,40



Fliesen | Tiles: SPARKS, NOCTURNE OPTIMA



Wohnen | *Living*

ATLANTA Wohnen · Living

Concept³

33 x 99 cm	33 x 99 cm	30 x 60 cm	30 x 60 cm
1333	1333	1581	1581
AL00	AL10	AL00	AL10
Grundfliese · Basic tile	Grundfliese · Basic tile	Grundfliese · Basic tile	Grundfliese · Basic tile
Werkmaße · Dimensions (mm)	329 x 991 x 11 mm	329 x 991 x 11 mm	297 x 597 x 9 mm
Farbe · Colour	light fog	light alabaster	light fog
Oberfläche · Finish	matt Belebte Betonoptik · matt Fresh concrete look	matt Belebte Betonoptik · matt Fresh concrete look	matt Belebte Betonoptik · matt Fresh concrete look
Erzeugnisgruppe	Steingut	Steingut	Steingut
Material	Nonvitreous	Nonvitreous	Nonvitreous
Maßeinheit · Unit of measure	m ² 19,13 kg 3,06 pce	m ² 19,13 kg 3,06 pce	m ² 15,56 kg 5,56 pce
Pro Paket · Per box	1,31 m ² 25 kg 4 pce	1,31 m ² 25 kg 4 pce	1,08 m ² 16,80 kg 6 pce
Pro Palette · Per pallet	36,59 m ² 700 kg 28 box	36,59 m ² 700 kg 28 box	51,84 m ² 806,40 kg 48 box
Mindestabgabereinheit · Min. sales unit	P (box)	P (box)	P (box)
Berechnungseinheit · Calculation unit	m ²	m ²	m ²
Preisgruppe · Price group	P110	P110	P87
60 x 120 cm	60 x 120 cm	60 x 120 cm	60 x 120 cm
2730	2730	2730	2730
AL10	AL70	AL80	AL40
Grundfliese · Basic tile	Grundfliese · Basic tile	Grundfliese · Basic tile	Grundfliese · Basic tile
Werkmaße · Dimensions (mm)	597 x 1197 x 10 mm	597 x 1197 x 10 mm	597 x 1197 x 10 mm
Farbe · Colour	alabaster white	sandy grey	foggy grey
Oberfläche · Finish	matt Belebte Betonoptik · matt Fresh concrete look	matt Belebte Betonoptik · matt Fresh concrete look	matt Belebte Betonoptik · matt Fresh concrete look
Erzeugnisgruppe	Feinsteinzeug	Feinsteinzeug	Feinsteinzeug
Material	Porcelain stoneware	Porcelain stoneware	Porcelain stoneware
Maßeinheit · Unit of measure	m ² 21,28 kg 1,39 pce	m ² 21,28 kg 1,39 pce	m ² 21,28 kg 1,39 pce
Pro Paket · Per box	1,44 m ² 30,64 kg 2 pce	1,44 m ² 30,64 kg 2 pce	1,44 m ² 30,64 kg 2 pce
Pro Palette · Per pallet	43,2 m ² 919,2 kg 30 box	43,2 m ² 919,2 kg 30 box	43,2 m ² 919,2 kg 30 box
Mindestabgabereinheit · Min. sales unit	P (box)	P (box)	P (box)
Berechnungseinheit · Calculation unit	m ²	m ²	m ²
Preisgruppe · Price group	P110	P110	P110

ATLANTA Wohnen · Living

Concept³



60 x 120 cm 2



60 x 120 cm 3

Artikelnummer · Article number
Warengruppe · Product group
Werksmaße · Dimensions (mm)
Farbe · Colour
Oberfläche · Finish
Erzeugnisgruppe
Material
Maßeinheit · Unit of measure
Pro Paket · Per box
Pro Palette · Per pallet
Mindestabgabereinheit · Min. sales unit
Berechnungseinheit · Calculation unit
Preisgruppe · Price group

2730
AL60
Grundfliese · Basic tile
597 x 1197 x 10 mm
concrete grey
matt Belebte Betonoptik · matt Fresh concrete look VilbostonePlus
Feinsteinzeug
Porcelain stoneware
m ² 21,28 kg 1,39 pce
1,44 m ² 30,64 kg 2 pce
43,2 m ² 919,2 kg 30 box
P (box)
m ²
P110

2730
AL90
Grundfliese · Basic tile
597 x 1197 x 10 mm
night grey
matt Belebte Betonoptik · matt Fresh concrete look VilbostonePlus
Feinsteinzeug
Porcelain stoneware
m ² 21,28 kg 1,39 pce
1,44 m ² 30,64 kg 2 pce
43,2 m ² 919,2 kg 30 box
P (box)
m ²
P110



80 x 80 cm 2



80 x 80 cm 2

Artikelnummer · Article number
Warengruppe · Product group
Werksmaße · Dimensions (mm)
Farbe · Colour
Oberfläche · Finish
Erzeugnisgruppe
Material
Maßeinheit · Unit of measure
Pro Paket · Per box
Pro Palette · Per pallet
Mindestabgabereinheit · Min. sales unit
Berechnungseinheit · Calculation unit
Preisgruppe · Price group

2810
AL10
Grundfliese · Basic tile
797 x 797 x 9 mm
alabaster white
matt Belebte Betonoptik · matt Fresh concrete look VilbostonePlus
Feinsteinzeug
Porcelain stoneware
m ² 19,06 kg 1,56 pce
1,28 m ² 24,40 kg 2 pce
51,20 m ² 976 kg 40 box
P (box)
m ²
P110

2810
AL70
Grundfliese · Basic tile
797 x 797 x 9 mm
sandy grey
matt Belebte Betonoptik · matt Fresh concrete look VilbostonePlus
Feinsteinzeug
Porcelain stoneware
m ² 19,06 kg 1,56 pce
1,28 m ² 24,40 kg 2 pce
51,20 m ² 976 kg 40 box
P (box)
m ²
P110

ATLANTA Wohnen · Living

Concept³



80 x 80 cm



2810

AL80



Grundfliese · Basic tile

797 x 797 x 9 mm

dark coffee

matt | Belebte Betonoptik · matt | Fresh concrete look

VilbostonePlus

Feinsteinzeug

Porcelain stoneware

m² | 19,06 kg | 1,56 pce

1,28 m² | 24,40 kg | 2 pce

51,20 m² | 976 kg | 40 box

P (box)

m²

P110



80 x 80 cm



2810

AL40



Grundfliese · Basic tile

797 x 797 x 9 mm

foggy grey

matt | Belebte Betonoptik · matt | Fresh concrete look

VilbostonePlus

Feinsteinzeug

Porcelain stoneware

m² | 19,06 kg | 1,56 pce

1,28 m² | 24,40 kg | 2 pce

51,20 m² | 976 kg | 40 box

P (box)

m²

P110



80 x 80 cm



2810

AL60



Grundfliese · Basic tile

797 x 797 x 9 mm

concrete grey

matt | Belebte Betonoptik · matt | Fresh concrete look

VilbostonePlus

Feinsteinzeug

Porcelain stoneware

m² | 19,06 kg | 1,56 pce

1,28 m² | 24,40 kg | 2 pce

51,20 m² | 976 kg | 40 box

P (box)

m²

P110



80 x 80 cm



2810

AL90



Grundfliese · Basic tile

797 x 797 x 9 mm

night grey

matt | Belebte Betonoptik · matt | Fresh concrete look

VilbostonePlus

Feinsteinzeug

Porcelain stoneware

m² | 19,06 kg | 1,56 pce

1,28 m² | 24,40 kg | 2 pce

51,20 m² | 976 kg | 40 box

P (box)

m²

P110

Artikelnummer · Article number

Warengruppe · Product group

Werkgröße · Dimensions (mm)

Farbe · Colour

Oberfläche · Finish

Erzeugnisgruppe

Material

Maßeinheit · Unit of measure

Pro Paket · Per box

Pro Palette · Per pallet

Mindestabgabereinheit · Min. sales unit

Berechnungseinheit · Calculation unit

Preisgruppe · Price group

Artikelnummer · Article number

Warengruppe · Product group

Werkgröße · Dimensions (mm)

Farbe · Colour

Oberfläche · Finish

Erzeugnisgruppe

Material

Maßeinheit · Unit of measure

Pro Paket · Per box

Pro Palette · Per pallet

Mindestabgabereinheit · Min. sales unit

Berechnungseinheit · Calculation unit

Preisgruppe · Price group

ATLANTA Wohnen · Living

Concept³

	60 x 60 cm		2660
Artikelnummer · Article number	AL10		
Warengruppe · Product group	Grundfliese · Basic tile		
Werkmaße · Dimensions (mm)	597 x 597 x 10 mm		
Farbe · Colour	alabaster white		
Oberfläche · Finish	matt Belebte Betonoptik · matt Fresh concrete look VilbostonePlus		
Erzeugnisgruppe	Feinsteinzeug		
Material	Porcelain stoneware		
Maßeinheit · Unit of measure	m ² 22,22 kg 2,78 pce		
Pro Paket · Per box	1,44 m ² 32 kg 4 pce		
Pro Palette · Per pallet	43,20 m ² 960 kg 30 box		
Mindestabgabereinheit · Min. sales unit	P (box)		
Berechnungseinheit · Calculation unit	m ²		
Preisgruppe · Price group	P99		
	60 x 60 cm		2660
Artikelnummer · Article number	AL70		
Warengruppe · Product group	Grundfliese · Basic tile		
Werkmaße · Dimensions (mm)	597 x 597 x 10 mm		
Farbe · Colour	sandy grey		
Oberfläche · Finish	matt Belebte Betonoptik · matt Fresh concrete look VilbostonePlus		
Erzeugnisgruppe	Feinsteinzeug		
Material	Porcelain stoneware		
Maßeinheit · Unit of measure	m ² 22,22 kg 2,78 pce		
Pro Paket · Per box	1,44 m ² 32 kg 4 pce		
Pro Palette · Per pallet	43,20 m ² 960 kg 30 box		
Mindestabgabereinheit · Min. sales unit	P (box)		
Berechnungseinheit · Calculation unit	m ²		
Preisgruppe · Price group	P99		
	60 x 60 cm		2660
Artikelnummer · Article number	AL80		
Warengruppe · Product group	Grundfliese · Basic tile		
Werkmaße · Dimensions (mm)	597 x 597 x 10 mm		
Farbe · Colour	dark coffee		
Oberfläche · Finish	matt Belebte Betonoptik · matt Fresh concrete look VilbostonePlus		
Erzeugnisgruppe	Feinsteinzeug		
Material	Porcelain stoneware		
Maßeinheit · Unit of measure	m ² 22,22 kg 2,78 pce		
Pro Paket · Per box	1,44 m ² 32 kg 4 pce		
Pro Palette · Per pallet	43,20 m ² 960 kg 30 box		
Mindestabgabereinheit · Min. sales unit	P (box)		
Berechnungseinheit · Calculation unit	m ²		
Preisgruppe · Price group	P99		
	60 x 60 cm		2660
Artikelnummer · Article number	AL40		
Warengruppe · Product group	Grundfliese · Basic tile		
Werkmaße · Dimensions (mm)	597 x 597 x 10 mm		
Farbe · Colour	foggy grey		
Oberfläche · Finish	matt Belebte Betonoptik · matt Fresh concrete look VilbostonePlus		
Erzeugnisgruppe	Feinsteinzeug		
Material	Porcelain stoneware		
Maßeinheit · Unit of measure	m ² 22,22 kg 2,78 pce		
Pro Paket · Per box	1,44 m ² 32 kg 4 pce		
Pro Palette · Per pallet	43,20 m ² 960 kg 30 box		
Mindestabgabereinheit · Min. sales unit	P (box)		
Berechnungseinheit · Calculation unit	m ²		
Preisgruppe · Price group	P99		
	60 x 60 cm		2660
Artikelnummer · Article number	AL60		
Warengruppe · Product group	Grundfliese · Basic tile		
Werkmaße · Dimensions (mm)	597 x 597 x 10 mm		
Farbe · Colour	concrete grey		
Oberfläche · Finish	matt Belebte Betonoptik · matt Fresh concrete look VilbostonePlus		
Erzeugnisgruppe	Feinsteinzeug		
Material	Porcelain stoneware		
Maßeinheit · Unit of measure	m ² 22,22 kg 2,78 pce		
Pro Paket · Per box	1,44 m ² 32 kg 4 pce		
Pro Palette · Per pallet	43,20 m ² 960 kg 30 box		
Mindestabgabereinheit · Min. sales unit	P (box)		
Berechnungseinheit · Calculation unit	m ²		
Preisgruppe · Price group	P99		
	60 x 60 cm		2660
Artikelnummer · Article number	AL90		
Warengruppe · Product group	Grundfliese · Basic tile		
Werkmaße · Dimensions (mm)	597 x 597 x 10 mm		
Farbe · Colour	night grey		
Oberfläche · Finish	matt Belebte Betonoptik · matt Fresh concrete look VilbostonePlus		
Erzeugnisgruppe	Feinsteinzeug		
Material	Porcelain stoneware		
Maßeinheit · Unit of measure	m ² 22,22 kg 2,78 pce		
Pro Paket · Per box	1,44 m ² 32 kg 4 pce		
Pro Palette · Per pallet	43,20 m ² 960 kg 30 box		
Mindestabgabereinheit · Min. sales unit	P (box)		
Berechnungseinheit · Calculation unit	m ²		
Preisgruppe · Price group	P99		
	30 x 60 cm		2394
Artikelnummer · Article number	AL10		
Warengruppe · Product group	Grundfliese · Basic tile		
Werkmaße · Dimensions (mm)	297 x 597 x 10 mm		
Farbe · Colour	alabaster white		
Oberfläche · Finish	matt Belebte Betonoptik · matt Fresh concrete look VilbostonePlus		
Erzeugnisgruppe	Feinsteinzeug		
Material	Porcelain stoneware		
Maßeinheit · Unit of measure	m ² 22,22 kg 5,56 pce		
Pro Paket · Per box	1,08 m ² 24 kg 6 pce		
Pro Palette · Per pallet	43,20 m ² 960 kg 40 box		
Mindestabgabereinheit · Min. sales unit	P (box)		
Berechnungseinheit · Calculation unit	m ²		
Preisgruppe · Price group	P87		
	30 x 60 cm		2394
Artikelnummer · Article number	AL70		
Warengruppe · Product group	Grundfliese · Basic tile		
Werkmaße · Dimensions (mm)	297 x 597 x 10 mm		
Farbe · Colour	sandy grey		
Oberfläche · Finish	matt Belebte Betonoptik · matt Fresh concrete look VilbostonePlus		
Erzeugnisgruppe	Feinsteinzeug		
Material	Porcelain stoneware		
Maßeinheit · Unit of measure	m ² 22,22 kg 5,56 pce		
Pro Paket · Per box	1,08 m ² 24 kg 6 pce		
Pro Palette · Per pallet	43,20 m ² 960 kg 40 box		
Mindestabgabereinheit · Min. sales unit	P (box)		
Berechnungseinheit · Calculation unit	m ²		
Preisgruppe · Price group	P87		
	30 x 60 cm		2394
Artikelnummer · Article number	AL60		
Warengruppe · Product group	Grundfliese · Basic tile		
Werkmaße · Dimensions (mm)	297 x 597 x 10 mm		
Farbe · Colour	concrete grey		
Oberfläche · Finish	matt Belebte Betonoptik · matt Fresh concrete look VilbostonePlus		
Erzeugnisgruppe	Feinsteinzeug		
Material	Porcelain stoneware		
Maßeinheit · Unit of measure	m ² 22,22 kg 5,56 pce		
Pro Paket · Per box	1,08 m ² 24 kg 6 pce		
Pro Palette · Per pallet	43,20 m ² 960 kg 40 box		
Mindestabgabereinheit · Min. sales unit	P (box)		
Berechnungseinheit · Calculation unit	m ²		
Preisgruppe · Price group	P87		
	30 x 60 cm		2394
Artikelnummer · Article number	AL90		
Warengruppe · Product group	Grundfliese · Basic tile		
Werkmaße · Dimensions (mm)	297 x 597 x 10 mm		
Farbe · Colour	night grey		
Oberfläche · Finish	matt Belebte Betonoptik · matt Fresh concrete look VilbostonePlus		
Erzeugnisgruppe	Feinsteinzeug		
Material	Porcelain stoneware		
Maßeinheit · Unit of measure	m ² 22,22 kg 5,56 pce		
Pro Paket · Per box	1,08 m ² 24 kg 6 pce		
Pro Palette · Per pallet	43,20 m ² 960 kg 40 box		
Mindestabgabereinheit · Min. sales unit	P (box)		
Berechnungseinheit · Calculation unit	m ²		
Preisgruppe · Price group	P87		

ATLANTA Wohnen · Living

Concept³



60 x 60 cm



60 x 60 cm



30 x 49 cm

□ 0,15 m² | 298 x 490 mm



30 x 49 cm

□ 0,15 m² | 298 x 490 mm

Artikelnummer · Article number
Warengruppe · Product group
Werkmaße · Dimensions (mm)
Farbe · Colour
Oberfläche · Finish
Erzeugnisgruppe
Material
Maßeinheit · Unit of measure
Pro Paket · Per box
Pro Palette · Per pallet
Mindestabgabereinheit · Min. sales unit
Berechnungseinheit · Calculation unit
Preisgruppe · Price group

2660
AL75
Dekor · Decor
597 x 597 x 10 mm
sand multicolor
matt Belebte Betonoptik · matt Fresh concrete look
Feinsteinzeug glasiert
Glazed porcelain stoneware
m ² 22,22 kg 2,78 pce
1,44 m ² 32 kg 4 pce
43,20 m ² 960 kg 30 box
P (box)
m ²
P99

2660
AL65
Dekor · Decor
597 x 597 x 10 mm
grey multicolor
matt Belebte Betonoptik · matt Fresh concrete look
Feinsteinzeug glasiert
Glazed porcelain stoneware
m ² 22,22 kg 2,78 pce
1,44 m ² 32 kg 4 pce
43,20 m ² 960 kg 30 box
P (box)
m ²
P99

2656
AL79
Dekor · Decor
298 x 490 x 10 mm
sand multicolor
matt Belebte Betonoptik · matt Fresh concrete look
Feinsteinzeug
Porcelain stoneware
m ² 21,67 kg 6,67 pce
0,60 m ² 13 kg 4 pce
21,60 m ² 468 kg 36 box
P (box)
m ²
P176

2656
AL69
Dekor · Decor
298 x 490 x 10 mm
grey multicolor
matt Belebte Betonoptik · matt Fresh concrete look
Feinsteinzeug
Porcelain stoneware
m ² 21,67 kg 6,67 pce
0,60 m ² 13 kg 4 pce
21,60 m ² 468 kg 36 box
P (box)
m ²
P176



7,5 x 7,5 cm

□ 0,09 m² | 297 x 297 mm

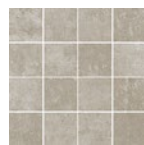

7,5 x 7,5 cm

□ 0,09 m² | 297 x 297 mm

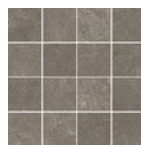

7,5 x 7,5 cm

□ 0,09 m² | 297 x 297 mm

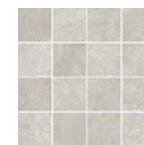

7,5 x 7,5 cm

□ 0,09 m² | 297 x 297 mm

Artikelnummer · Article number
Warengruppe · Product group
Werkmaße · Dimensions (mm)
Farbe · Colour
Oberfläche · Finish
Erzeugnisgruppe
Material
Maßeinheit · Unit of measure
Pro Paket · Per box
Pro Palette · Per pallet
Mindestabgabereinheit · Min. sales unit
Berechnungseinheit · Calculation unit
Preisgruppe · Price group

2013
AL10
Grundfliese · Basic tile
72 x 72 x 10 mm
alabaster white
matt Belebte Betonoptik · matt Fresh concrete look
Feinsteinzeug
Porcelain stoneware
m ² 21,45 kg 11 pce
1 m ² 21,45 kg 11 pce
36 m ² 772,20 kg 36 box
P (box)
m ²
P164

2013
AL70
Grundfliese · Basic tile
72 x 72 x 10 mm
sandy grey
matt Belebte Betonoptik · matt Fresh concrete look
Feinsteinzeug
Porcelain stoneware
m ² 21,45 kg 11 pce
1 m ² 21,45 kg 11 pce
36 m ² 772,20 kg 36 box
P (box)
m ²
P164

2013
AL80
Grundfliese · Basic tile
72 x 72 x 10 mm
dark coffee
matt Belebte Betonoptik · matt Fresh concrete look
Feinsteinzeug
Porcelain stoneware
m ² 21,45 kg 11 pce
1 m ² 21,45 kg 11 pce
36 m ² 772,20 kg 36 box
P (box)
m ²
P164

2013
AL40
Grundfliese · Basic tile
72 x 72 x 10 mm
foggy grey
matt Belebte Betonoptik · matt Fresh concrete look
Feinsteinzeug
Porcelain stoneware
m ² 21,45 kg 11 pce
1 m ² 21,45 kg 11 pce
36 m ² 772,20 kg 36 box
P (box)
m ²
P164



7,5 x 7,5 cm

□ 0,09 m² | 297 x 297 mm

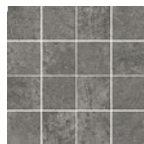

7,5 x 7,5 cm

□ 0,09 m² | 297 x 297 mm

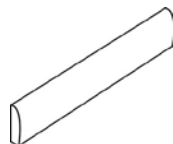

7,5 x 60 cm

Artikelnummer · Article number
Warengruppe · Product group
Werkmaße · Dimensions (mm)
Farbe · Colour
Oberfläche · Finish
Erzeugnisgruppe
Material
Maßeinheit · Unit of measure
Pro Paket · Per box
Pro Palette · Per pallet
Mindestabgabereinheit · Min. sales unit
Berechnungseinheit · Calculation unit
Preisgruppe · Price group

2013
AL60
Grundfliese · Basic tile
72 x 72 x 10 mm
concrete grey
matt Belebte Betonoptik · matt Fresh concrete look
Feinsteinzeug
Porcelain stoneware
m ² 21,45 kg 11 pce
1 m ² 21,45 kg 11 pce
36 m ² 772,20 kg 36 box
P (box)
m ²
P164

2013
AL90
Grundfliese · Basic tile
72 x 72 x 10 mm
night grey
matt Belebte Betonoptik · matt Fresh concrete look
Feinsteinzeug
Porcelain stoneware
m ² 21,45 kg 11 pce
1 m ² 21,45 kg 11 pce
36 m ² 772,20 kg 36 box
P (box)
m ²
P164

2872
AL10, AL40, AL60
AL70, AL80, AL90
Sockel · Skirting
72 x 597 x 10 mm
-
matt Belebte Betonoptik · matt Fresh concrete look
Feinsteinzeug
Porcelain stoneware
m 1,64 kg 1,67 pce
11,98 m 19,60 kg 20 pce
574,85 m 940,80 kg 48 box
E (pce)
Stück · piece
E51

BACK HOME Wohnen Basis · Living Basis

Concept³

30 x 60 cm	30 x 60 cm	30 x 60 cm	30 x 60 cm
1571	1571	1571	1571
BT01	BT02	BT21	BT22
Grundfliese · Basic tile	Grundfliese · Basic tile	Grundfliese · Basic tile	Grundfliese · Basic tile
Werkmaße · Dimensions (mm) 297 x 597 x 9 mm	Werkmaße · Dimensions (mm) 297 x 597 x 9 mm	Werkmaße · Dimensions (mm) 297 x 597 x 9 mm	Werkmaße · Dimensions (mm) 297 x 597 x 9 mm
Farbe · Colour white	Farbe · Colour white	Farbe · Colour creme	Farbe · Colour creme
Oberfläche · Finish matt Steinstruktur · matt stone texture CeramicPlus	Oberfläche · Finish glänzend Steinstruktur · glossy stone texture CeramicPlus	Oberfläche · Finish matt Steinstruktur · matt stone texture CeramicPlus	Oberfläche · Finish glänzend Steinstruktur · glossy stone texture CeramicPlus
Erzeugnisgruppe Steingut	Erzeugnisgruppe Steingut	Erzeugnisgruppe Steingut	Erzeugnisgruppe Steingut
Material Nonvitreous	Material Nonvitreous	Material Nonvitreous	Material Nonvitreous
Maßeinheit · Unit of measure m ² 15,56 kg 5,56 pce	Maßeinheit · Unit of measure m ² 15,56 kg 5,56 pce	Maßeinheit · Unit of measure m ² 15,56 kg 5,56 pce	Maßeinheit · Unit of measure m ² 15,56 kg 5,56 pce
Pro Paket · Per box 1,08 m ² 16,80 kg 6 pce	Pro Paket · Per box 1,08 m ² 16,80 kg 6 pce	Pro Paket · Per box 1,08 m ² 16,80 kg 6 pce	Pro Paket · Per box 1,08 m ² 16,80 kg 6 pce
Pro Palette · Per pallet 51,84 m ² 806,40 kg 48 box	Pro Palette · Per pallet 51,84 m ² 806,40 kg 48 box	Pro Palette · Per pallet 51,84 m ² 806,40 kg 48 box	Pro Palette · Per pallet 51,84 m ² 806,40 kg 48 box
Mindestabgabereinheit · Min. sales unit P (box)	Mindestabgabereinheit · Min. sales unit P (box)	Mindestabgabereinheit · Min. sales unit P (box)	Mindestabgabereinheit · Min. sales unit P (box)
Berechnungseinheit · Calculation unit m ²	Berechnungseinheit · Calculation unit m ²	Berechnungseinheit · Calculation unit m ²	Berechnungseinheit · Calculation unit m ²
Preisgruppe · Price group P71	Preisgruppe · Price group P71	Preisgruppe · Price group P71	Preisgruppe · Price group P71
20 x 60 cm	20 x 60 cm	20 x 60 cm	20 x 60 cm
1260	1260	1260	1260
BT01	BT02	BT21	BT22
Grundfliese · Basic tile	Grundfliese · Basic tile	Grundfliese · Basic tile	Grundfliese · Basic tile
Werkmaße · Dimensions (mm) 197 x 597 x 9 mm	Werkmaße · Dimensions (mm) 197 x 597 x 9 mm	Werkmaße · Dimensions (mm) 197 x 597 x 9 mm	Werkmaße · Dimensions (mm) 197 x 597 x 9 mm
Farbe · Colour white	Farbe · Colour white	Farbe · Colour creme	Farbe · Colour creme
Oberfläche · Finish matt Steinstruktur · matt stone texture CeramicPlus	Oberfläche · Finish glänzend Steinstruktur · glossy stone texture CeramicPlus	Oberfläche · Finish matt Steinstruktur · matt stone texture CeramicPlus	Oberfläche · Finish glänzend Steinstruktur · glossy stone texture CeramicPlus
Erzeugnisgruppe Steingut	Erzeugnisgruppe Steingut	Erzeugnisgruppe Steingut	Erzeugnisgruppe Steingut
Material Nonvitreous	Material Nonvitreous	Material Nonvitreous	Material Nonvitreous
Maßeinheit · Unit of measure m ² 15,42 kg 8,33 pce	Maßeinheit · Unit of measure m ² 15,42 kg 8,33 pce	Maßeinheit · Unit of measure m ² 15,42 kg 8,33 pce	Maßeinheit · Unit of measure m ² 15,42 kg 8,33 pce
Pro Paket · Per box 1,08 m ² 16,65 kg 9 pce	Pro Paket · Per box 1,08 m ² 16,65 kg 9 pce	Pro Paket · Per box 1,08 m ² 16,65 kg 9 pce	Pro Paket · Per box 1,08 m ² 16,65 kg 9 pce
Pro Palette · Per pallet 69,12 m ² 1065,60 kg 64 box	Pro Palette · Per pallet 69,12 m ² 1065,60 kg 64 box	Pro Palette · Per pallet 69,12 m ² 1065,60 kg 64 box	Pro Palette · Per pallet 69,12 m ² 1065,60 kg 64 box
Mindestabgabereinheit · Min. sales unit P (box)	Mindestabgabereinheit · Min. sales unit P (box)	Mindestabgabereinheit · Min. sales unit P (box)	Mindestabgabereinheit · Min. sales unit P (box)
Berechnungseinheit · Calculation unit m ²	Berechnungseinheit · Calculation unit m ²	Berechnungseinheit · Calculation unit m ²	Berechnungseinheit · Calculation unit m ²
Preisgruppe · Price group P71	Preisgruppe · Price group P71	Preisgruppe · Price group P71	Preisgruppe · Price group P71
60 x 60 cm	60 x 60 cm	60 x 60 cm	60 x 60 cm
2349	2349	2349	2349
BT10	BT20	BT60	BT90
Grundfliese · Basic tile	Grundfliese · Basic tile	Grundfliese · Basic tile	Grundfliese · Basic tile
Werkmaße · Dimensions (mm) 597 x 597 x 9 mm	Werkmaße · Dimensions (mm) 597 x 597 x 9 mm	Werkmaße · Dimensions (mm) 597 x 597 x 9 mm	Werkmaße · Dimensions (mm) 597 x 597 x 9 mm
Farbe · Colour natural white	Farbe · Colour beige	Farbe · Colour stone grey	Farbe · Colour anthracite
Oberfläche · Finish matt Steinstruktur · matt stone texture VilbostonePlus	Oberfläche · Finish matt Steinstruktur · matt stone texture VilbostonePlus	Oberfläche · Finish matt Steinstruktur · matt stone texture VilbostonePlus	Oberfläche · Finish matt Steinstruktur · matt stone texture VilbostonePlus
Erzeugnisgruppe Feinsteinzeug	Erzeugnisgruppe Feinsteinzeug	Erzeugnisgruppe Feinsteinzeug	Erzeugnisgruppe Feinsteinzeug
Material Porcelain stoneware	Material Porcelain stoneware	Material Porcelain stoneware	Material Porcelain stoneware
Maßeinheit · Unit of measure m ² 22,22 kg 2,78 pce	Maßeinheit · Unit of measure m ² 22,22 kg 2,78 pce	Maßeinheit · Unit of measure m ² 22,22 kg 2,78 pce	Maßeinheit · Unit of measure m ² 22,22 kg 2,78 pce
Pro Paket · Per box 1,44 m ² 32 kg 4 pce	Pro Paket · Per box 1,44 m ² 32 kg 4 pce	Pro Paket · Per box 1,44 m ² 32 kg 4 pce	Pro Paket · Per box 1,44 m ² 32 kg 4 pce
Pro Palette · Per pallet 43,20 m ² 960 kg 30 box	Pro Palette · Per pallet 43,20 m ² 960 kg 30 box	Pro Palette · Per pallet 43,20 m ² 960 kg 30 box	Pro Palette · Per pallet 43,20 m ² 960 kg 30 box
Mindestabgabereinheit · Min. sales unit P (box)	Mindestabgabereinheit · Min. sales unit P (box)	Mindestabgabereinheit · Min. sales unit P (box)	Mindestabgabereinheit · Min. sales unit P (box)
Berechnungseinheit · Calculation unit m ²	Berechnungseinheit · Calculation unit m ²	Berechnungseinheit · Calculation unit m ²	Berechnungseinheit · Calculation unit m ²
Preisgruppe · Price group P74	Preisgruppe · Price group P74	Preisgruppe · Price group P74	Preisgruppe · Price group P74

BACK HOME Wohnen Basis · Living Basis

Concept³

	45 x 45 cm	45 x 45 cm	45 x 45 cm	45 x 45 cm
Artikelnummer · Article number	2733	2733	2733	2733
Warengruppe · Product group	BT10	BT20	BT60	BT90
Werkmaße · Dimensions (mm)	Grundfliese · Basic tile 447 x 447 x 9 mm	Grundfliese · Basic tile 447 x 447 x 9 mm	Grundfliese · Basic tile 447 x 447 x 9 mm	Grundfliese · Basic tile 447 x 447 x 9 mm
Farbe · Colour	natural white	beige	stone grey	anthracite
Oberfläche · Finish	matt Steinstruktur · matt stone texture	matt Steinstruktur · matt stone texture	matt Steinstruktur · matt stone texture	matt Steinstruktur · matt stone texture
Erzeugnisgruppe	Feinsteinzeug	Feinsteinzeug	Feinsteinzeug	Feinsteinzeug
Material	Porcelain stoneware	Porcelain stoneware	Porcelain stoneware	Porcelain stoneware
Maßeinheit · Unit of measure	m ² 19,75 kg 4,94 pce	m ² 19,75 kg 4,94 pce	m ² 19,75 kg 4,94 pce	m ² 19,75 kg 4,94 pce
Pro Paket · Per box	1,42 m ² 28 kg 7 pce	1,42 m ² 28 kg 7 pce	1,42 m ² 28 kg 7 pce	1,42 m ² 28 kg 7 pce
Pro Palette · Per pallet	36,86 m ² 728 kg 26 box	36,86 m ² 728 kg 26 box	36,86 m ² 728 kg 26 box	36,86 m ² 728 kg 26 box
Mindestabgabereinheit · Min. sales unit	P (box)	P (box)	P (box)	P (box)
Berechnungseinheit · Calculation unit	m ²	m ²	m ²	m ²
Preisgruppe · Price group	P71	P71	P71	P71
	30 x 60 cm	30 x 60 cm	30 x 60 cm	30 x 60 cm
Artikelnummer · Article number	2085	2085	2085	2085
Warengruppe · Product group	BT10	BT20	BT60	BT90
Werkmaße · Dimensions (mm)	Grundfliese · Basic tile 297 x 597 x 9 mm	Grundfliese · Basic tile 297 x 597 x 9 mm	Grundfliese · Basic tile 297 x 597 x 9 mm	Grundfliese · Basic tile 297 x 597 x 9 mm
Farbe · Colour	natural white	beige	stone grey	anthracite
Oberfläche · Finish	matt Steinstruktur · matt stone texture	matt Steinstruktur · matt stone texture	matt Steinstruktur · matt stone texture	matt Steinstruktur · matt stone texture
Erzeugnisgruppe	Feinsteinzeug	Feinsteinzeug	Feinsteinzeug	Feinsteinzeug
Material	Porcelain stoneware	Porcelain stoneware	Porcelain stoneware	Porcelain stoneware
Maßeinheit · Unit of measure	m ² 20 kg 5,56 pce	m ² 20 kg 5,56 pce	m ² 20 kg 5,56 pce	m ² 20 kg 5,56 pce
Pro Paket · Per box	1,08 m ² 21,60 kg 6 pce	1,08 m ² 21,60 kg 6 pce	1,08 m ² 21,60 kg 6 pce	1,08 m ² 21,60 kg 6 pce
Pro Palette · Per pallet	43,20 m ² 864 kg 40 box	43,20 m ² 864 kg 40 box	43,20 m ² 864 kg 40 box	43,20 m ² 864 kg 40 box
Mindestabgabereinheit · Min. sales unit	P (box)	P (box)	P (box)	P (box)
Berechnungseinheit · Calculation unit	m ²	m ²	m ²	m ²
Preisgruppe · Price group	P87	P87	P87	P87
	30 x 60 cm	30 x 60 cm	30 x 60 cm	30 x 60 cm
	□ 0,18 m ² 297 x 597 mm	□ 0,18 m ² 297 x 597 mm	□ 0,18 m ² 297 x 597 mm	□ 0,18 m ² 297 x 597 mm
Artikelnummer · Article number	2039	2039	2039	2039
Warengruppe · Product group	BT10	BT20	BT60	BT90
Werkmaße · Dimensions (mm)	Dekor · Decor 297 x 597 x 9 mm	Dekor · Decor 297 x 597 x 9 mm	Dekor · Decor 297 x 597 x 9 mm	Dekor · Decor 297 x 597 x 9 mm
Farbe · Colour	natural white	beige	stone grey	anthracite
Oberfläche · Finish	matt Steinstruktur · matt stone texture	matt Steinstruktur · matt stone texture	matt Steinstruktur · matt stone texture	matt Steinstruktur · matt stone texture
Erzeugnisgruppe	Feinsteinzeug	Feinsteinzeug	Feinsteinzeug	Feinsteinzeug
Material	Porcelain stoneware	Porcelain stoneware	Porcelain stoneware	Porcelain stoneware
Maßeinheit · Unit of measure	m ² 20,50 kg 5,56 pce	m ² 20,50 kg 5,56 pce	m ² 20,50 kg 5,56 pce	m ² 20,50 kg 5,56 pce
Pro Paket · Per box	0,90 m ² 18,45 kg 5 pce	0,90 m ² 18,45 kg 5 pce	0,90 m ² 18,45 kg 5 pce	0,90 m ² 18,45 kg 5 pce
Pro Palette · Per pallet	32,40 m ² 664,20 kg 36 box	32,40 m ² 664,20 kg 36 box	32,40 m ² 664,20 kg 36 box	32,40 m ² 664,20 kg 36 box
Mindestabgabereinheit · Min. sales unit	P (box)	P (box)	P (box)	P (box)
Berechnungseinheit · Calculation unit	m ²	m ²	m ²	m ²
Preisgruppe · Price group	P168	P168	P168	P168

BACK HOME Wohnen Basis · Living Basis

Concept³

5 x 5 cm	5 x 5 cm	5 x 5 cm	5 x 5 cm
□ 0,09 m ² 298 x 298 mm	□ 0,09 m ² 298 x 298 mm	□ 0,09 m ² 298 x 298 mm	□ 0,09 m ² 298 x 298 mm
2706	2706	2706	2706
BT10	BT20	BT60	BT90
Grundfliese · Basic tile	Grundfliese · Basic tile	Grundfliese · Basic tile	Grundfliese · Basic tile
Werkmaße · Dimensions (mm)	Werkmaße · Dimensions (mm)	Werkmaße · Dimensions (mm)	Werkmaße · Dimensions (mm)
48 x 48 x 6 mm	48 x 48 x 6 mm	48 x 48 x 6 mm	48 x 48 x 6 mm
Farbe · Colour	Farbe · Colour	Farbe · Colour	Farbe · Colour
natural white	beige	stone grey	anthracite
Oberfläche · Finish	Oberfläche · Finish	Oberfläche · Finish	Oberfläche · Finish
matt Steinstruktur · matt stone texture	matt Steinstruktur · matt stone texture	matt Steinstruktur · matt stone texture	matt Steinstruktur · matt stone texture
Erzeugnisgruppe	Erzeugnisgruppe	Erzeugnisgruppe	Erzeugnisgruppe
Feinsteinzeug glasiert	Feinsteinzeug glasiert	Feinsteinzeug glasiert	Feinsteinzeug glasiert
Material	Material	Material	Material
Glazed porcelain stoneware	Glazed porcelain stoneware	Glazed porcelain stoneware	Glazed porcelain stoneware
Maßeinheit · Unit of measure	Maßeinheit · Unit of measure	Maßeinheit · Unit of measure	Maßeinheit · Unit of measure
m ² 11,77 kg 11 pce	m ² 11,77 kg 11 pce	m ² 11,77 kg 11 pce	m ² 11,77 kg 11 pce
Pro Paket · Per box	Pro Paket · Per box	Pro Paket · Per box	Pro Paket · Per box
1 m ² 11,77 kg 11 pce	1 m ² 11,77 kg 11 pce	1 m ² 11,77 kg 11 pce	1 m ² 11,77 kg 11 pce
Pro Palette · Per pallet	Pro Palette · Per pallet	Pro Palette · Per pallet	Pro Palette · Per pallet
78 m ² 918,06 kg 78 box	78 m ² 918,06 kg 78 box	78 m ² 918,06 kg 78 box	78 m ² 918,06 kg 78 box
Mindestabgabereinheit · Min. sales unit	Mindestabgabereinheit · Min. sales unit	Mindestabgabereinheit · Min. sales unit	Mindestabgabereinheit · Min. sales unit
P (box)	P (box)	P (box)	P (box)
Berechnungseinheit · Calculation unit	Berechnungseinheit · Calculation unit	Berechnungseinheit · Calculation unit	Berechnungseinheit · Calculation unit
m ²	m ²	m ²	m ²
Preisgruppe · Price group	Preisgruppe · Price group	Preisgruppe · Price group	Preisgruppe · Price group
P123	P123	P123	P123

BELLAGIO *Excellence* by Villeroy & Boch



Concept³

30 x 60 cm	60 x 60 cm	60 x 60 cm	30 x 30 cm
□ 0,09 m ² 298 x 298 mm	□ 0,09 m ² 298 x 298 mm	□ 0,09 m ² 298 x 298 mm	□ 0,09 m ² 298 x 298 mm
1581	2660	2660	2079
TM01	TM6M	TM6L	TM60
Grundfliese · Basic tile	Grundfliese · Basic tile	Grundfliese · Basic tile	Dekor · Decor
Werkmaße · Dimensions (mm)	Werkmaße · Dimensions (mm)	Werkmaße · Dimensions (mm)	Werkmaße · Dimensions (mm)
297 x 597 x 9 mm	597 x 597 x 9 mm	597 x 597 x 9 mm	298 x 298 x 9 mm
Farbe · Colour	Farbe · Colour	Farbe · Colour	Farbe · Colour
light shadow	shadow	shadow	shadow
Oberfläche · Finish	Oberfläche · Finish	Oberfläche · Finish	Oberfläche · Finish
glänzend Harmonischer Marmor-Terrazzo-Mix · glossy Harmonious marble terrazzo mix CeramicPlus	matt Harmonischer Marmor-Terrazzo-Mix · matt Harmonious marble terrazzo mix VilbstonePlus	geläpft/anpoliert Harmonischer Marmor-Terrazzo-Mix · rough-polished Harmonious marble terrazzo mix VilbstonePlus	matt Harmonischer Marmor-Terrazzo-Mix · matt Harmonious marble terrazzo mix VilbstonePlus
Erzeugnisgruppe	Erzeugnisgruppe	Erzeugnisgruppe	Erzeugnisgruppe
Steingut	Feinsteinzeug	Feinsteinzeug	Feinsteinzeug
Material	Material	Material	Material
Nonvitreous	Porcelain stoneware	Porcelain stoneware	Porcelain stoneware
Maßeinheit · Unit of measure	Maßeinheit · Unit of measure	Maßeinheit · Unit of measure	Maßeinheit · Unit of measure
m ² 15,56 kg 5,56 pce	m ² 20 kg 2,78 pce	m ² 20 kg 2,78 pce	m ² 19,80 kg 5,50 pce
Pro Paket · Per box	Pro Paket · Per box	Pro Paket · Per box	Pro Paket · Per box
1,08 m ² 16,80 kg 6 pce	1,44 m ² 28,80 kg 4 pce	1,44 m ² 28,80 kg 4 pce	1,27 m ² 25,20 kg 7 pce
Pro Palette · Per pallet	Pro Palette · Per pallet	Pro Palette · Per pallet	Pro Palette · Per pallet
51,84 m ² 806,40 kg 48 box	43,20 m ² 864 kg 30 box	43,20 m ² 864 kg 30 box	45,82 m ² 907,20 kg 36 box
Mindestabgabereinheit · Min. sales unit	Mindestabgabereinheit · Min. sales unit	Mindestabgabereinheit · Min. sales unit	Mindestabgabereinheit · Min. sales unit
P (box)	P (box)	P (box)	P (box)
Berechnungseinheit · Calculation unit	Berechnungseinheit · Calculation unit	Berechnungseinheit · Calculation unit	Berechnungseinheit · Calculation unit
m ²	m ²	m ²	m ²
Preisgruppe · Price group	Preisgruppe · Price group	Preisgruppe · Price group	Preisgruppe · Price group
P93	P99	P110	P193



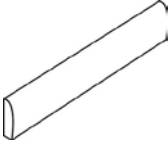
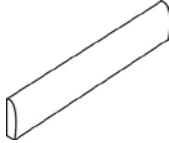

2 Stück im Set
2 piece set

BELLAGIO *Excellence* by Villeroy & Boch

Concept³

				
	30 x 30 cm □ 0,09 m ² 298 x 298 mm	5 x 5 cm □ 0,09 m ² 298 x 298 mm	7,5 x 60 cm	7,5 x 60 cm
Artikelnummer · Article number	2078	2030	2872	2872
Warengruppe · Product group	TM60	TM6M	TM6M	TM6L
Dekor · Decor	Grundfliese · Basic tile	Grundfliese · Basic tile	Sockel · Skirting	Sockel · Skirting
Werksmaße · Dimensions (mm)	298 x 298 x 9 mm	48 x 48 x 9 mm	72 x 597 x 9 mm	72 x 597 x 9 mm
Farbe · Colour	shadow	shadow	shadow	shadow
Oberfläche · Finish	matt Harmonischer Marmor-Terrazzo-Mix · matt Harmonious marble terrazzo mix	matt Harmonischer Marmor-Terrazzo-Mix · matt Harmonious marble terrazzo mix	matt Harmonischer Marmor-Terrazzo-Mix · matt Harmonious marble terrazzo mix	geläpft/anpoliert Harmonischer Marmor-Terrazzo-Mix · rough-polished Harmonious marble terrazzo mix
	VilbostonePlus	VilbostonePlus	VilbostonePlus	VilbostonePlus
Erzeugnisgruppe	Feinsteinzeug	Feinsteinzeug	Feinsteinzeug	Feinsteinzeug
Material	Porcelain stoneware	Porcelain stoneware	Porcelain stoneware	Porcelain stoneware
Maßeinheit · Unit of measure	m ² 19,80 kg 11 pce	m ² 19,80 kg 11 pce	m 1,46 kg 1,66 pce	m 1,46 kg 1,66 pce
Pro Paket · Per box	1,09 m ² 21,60 kg 12 pce	1,09 m ² 21,60 kg 12 pce	12,05 m 17,60 kg 20 pce	12,05 m 17,60 kg 20 pce
Pro Palette · Per pallet	39,27 m ² 777,60 kg 36 box	39,27 m ² 777,60 kg 36 box	578,31 m 844,80 kg 48 box	578,31 m 844,80 kg 48 box
Mindestabgabereinheit · Min. sales unit	P (box)	P (box)	E (pce)	E (pce)
Berechnungseinheit · Calculation unit	m ²	m ²	Stück · piece	Stück · piece
Preisgruppe · Price group	P193	P179	E53	E60

BERNINA Wohnen · Living

				
	60 x 60 cm	30 x 60 cm	30 x 60 cm	15 x 60 cm
Artikelnummer · Article number	2660	2394	2392	2409
Warengruppe · Product group	RT2M	RT2M	RT2M	RT2M
Dekor · Decor	Grundfliese · Basic tile	Grundfliese · Basic tile	Grundfliese · Basic tile	Grundfliese · Basic tile
Werksmaße · Dimensions (mm)	597 x 597 x 10 mm	297 x 597 x 10 mm	297 x 597 x 10 mm	147 x 597 x 10 mm
Farbe · Colour	anthrazit · anthracite	anthrazit · anthracite	anthrazit · anthracite	anthrazit · anthracite
Oberfläche · Finish	matt Feinadrige Quarzitoptik · matt Fine-veined quartzite look	matt Feinadrige Quarzitoptik · matt Fine-veined quartzite look	matt Feinadrige Quarzitoptik · matt Fine-veined quartzite look	matt Feinadrige Quarzitoptik · matt Fine-veined quartzite look
	VilbostonePlus	VilbostonePlus	VilbostonePlus	VilbostonePlus
Erzeugnisgruppe	Feinsteinzeug	Feinsteinzeug	Feinsteinzeug	Feinsteinzeug
Material	Porcelain stoneware	Porcelain stoneware	Porcelain stoneware	Porcelain stoneware
Maßeinheit · Unit of measure	m ² 22,22 kg 2,78 pce	m ² 22,22 kg 5,56 pce	m ² 21,67 kg 5,56 pce	m ² 22,22 kg 11,11 pce
Pro Paket · Per box	1,44 m ² 32 kg 4 pce	1,08 m ² 24 kg 6 pce	1,08 m ² 23,40 kg 6 pce	0,90 m ² 20 kg 10 pce
Pro Palette · Per pallet	43,20 m ² 960 kg 30 box	43,20 m ² 960 kg 40 box	43,20 m ² 936 kg 40 box	43,20 m ² 960 kg 48 box
Mindestabgabereinheit · Min. sales unit	P (box)	P (box)	P (box)	P (box)
Berechnungseinheit · Calculation unit	m ²	m ²	m ²	m ²
Preisgruppe · Price group	P99	P87	P87	P175

Auftragsbezogene Fertigung. Mindestbestellmenge 100 m². Lieferzeit auf Anfrage.
 Custom-made production. Minimum order quantity 100 m². Delivery time on request.

BERNINA Wohnen · Living

7,5 x 60 cm	3,3 x 7,5 cm □ 0,09 m ² 298 x 298 mm	30 x 50 cm □ 0,15 m ² 297 x 497 mm	7,5 x 60 cm
2410	2411	2650	2872
RT2M	RT2M	RT2M	RT2M
Grundfliese · Basic tile	Grundfliese · Basic tile	Dekor · Decor	Sockel · Skirting
72 x 597 x 10 mm	31,33 x 73 x 10 mm	298 x 498 x 10 mm	72 x 597 x 10 mm
anthrazit · anthracite	anthrazit · anthracite	anthrazit · anthracite	anthrazit · anthracite
matt Feinadrige Quarzoptik · matt Fine-veined quartzite look	matt Feinadrige Quarzoptik · matt Fine-veined quartzite look	matt Feinadrige Quarzoptik · matt Fine-veined quartzite look	matt Feinadrige Quarzoptik · matt Fine-veined quartzite look
VilbostonePlus	VilbostonePlus	VilbostonePlus	VilbostonePlus
Feinsteinzeug	Feinsteinzeug	Feinsteinzeug	Feinsteinzeug
Porcelain stoneware	Porcelain stoneware	Porcelain stoneware	Porcelain stoneware
m ² 21,78 kg 22,22 pce	m ² 21,45 kg 11 pce	m ² 18 kg 6,67 pce	m 1,64 kg 1,67 pce
0,90 m ² 19,60 kg 20 pce	1 m ² 21,45 kg 11 pce	0,60 m ² 10,80 kg 4 pce	11,98 m 19,60 kg 20 pce
43,20 m ² 940,80 kg 48 box	36 m ² 772,20 kg 36 box	18 m ² 324 kg 30 box	574,85 m 940,80 kg 48 box
P (box)	P (box)	P (box)	E (pce)
m ²	m ²	m ²	Stück · piece
P183	P208	P190	E53

BOURGOGNA Wohnen · Living

60 x 120 cm NEW 2023	60 x 120 cm NEW 2023	60 x 120 cm NEW 2023	60 x 120 cm NEW 2023
2736	2736	2736	2736
DM20	DM70	DM60	DM90
Grundfliese · Basic tile	Grundfliese · Basic tile	Grundfliese · Basic tile	Grundfliese · Basic tile
597 x 1197 x 10 mm	597 x 1197 x 10 mm	597 x 1197 x 10 mm	597 x 1197 x 10 mm
beige	greige	grey	anthracite
matt Belebte Natursteinoptik · matt Fresh natural-stone look	matt Belebte Natursteinoptik · matt Fresh natural-stone look	matt Belebte Natursteinoptik · matt Fresh natural-stone look	matt Belebte Natursteinoptik · matt Fresh natural-stone look
VilbostonePlus	VilbostonePlus	VilbostonePlus	VilbostonePlus
Feinsteinzeug	Feinsteinzeug	Feinsteinzeug	Feinsteinzeug
Porcelain stoneware	Porcelain stoneware	Porcelain stoneware	Porcelain stoneware
m ² 21,28 kg 1,39 pce	m ² 21,28 kg 1,39 pce	m ² 21,28 kg 1,39 pce	m ² 21,28 kg 1,39 pce
1,44 m ² 30,64 kg 2 pce	1,44 m ² 30,64 kg 2 pce	1,44 m ² 30,64 kg 2 pce	1,44 m ² 30,64 kg 2 pce
43,2 m ² 919,2 kg 30 box	43,2 m ² 919,2 kg 30 box	43,2 m ² 919,2 kg 30 box	43,2 m ² 919,2 kg 30 box
P (box)	P (box)	P (box)	P (box)
m ²	m ²	m ²	m ²
P110	P110	P110	P110

BOURGOGNA Wohnen · Living



80 x 80 cm
NEW 2023



80 x 80 cm
NEW 2023



Artikelnummer · Article number	2834
Warengruppe · Product group	Grundfliese · Basic tile
Werksmaße · Dimensions (mm)	797 x 797 x 9 mm
Farbe · Colour	beige
Oberfläche · Finish	matt Belebte Natursteinoptik · matt Fresh natural-stone look
Erzeugnisgruppe	Feinsteinzeug
Material	Porcelain stoneware
Maßeinheit · Unit of measure	m ² 19,06 kg 1,56 pce
Pro Paket · Per box	1,28 m ² 24,40 kg 2 pce
Pro Palette · Per pallet	51,20 m ² 976 kg 40 box
Mindestabgabereinheit · Min. sales unit	P (box)
Berechnungseinheit · Calculation unit	m ²
Preisgruppe · Price group	P110

Artikelnummer · Article number	2834
Warengruppe · Product group	Grundfliese · Basic tile
Werksmaße · Dimensions (mm)	797 x 797 x 9 mm
Farbe · Colour	greige
Oberfläche · Finish	matt Belebte Natursteinoptik · matt Fresh natural-stone look
Erzeugnisgruppe	Feinsteinzeug
Material	Porcelain stoneware
Maßeinheit · Unit of measure	m ² 19,06 kg 1,56 pce
Pro Paket · Per box	1,28 m ² 24,40 kg 2 pce
Pro Palette · Per pallet	51,20 m ² 976 kg 40 box
Mindestabgabereinheit · Min. sales unit	P (box)
Berechnungseinheit · Calculation unit	m ²
Preisgruppe · Price group	P110



80 x 80 cm
NEW 2023



80 x 80 cm
NEW 2023



Artikelnummer · Article number	2834
Warengruppe · Product group	Grundfliese · Basic tile
Werksmaße · Dimensions (mm)	797 x 797 x 9 mm
Farbe · Colour	grey
Oberfläche · Finish	matt Belebte Natursteinoptik · matt Fresh natural-stone look
Erzeugnisgruppe	Feinsteinzeug
Material	Porcelain stoneware
Maßeinheit · Unit of measure	m ² 19,06 kg 1,56 pce
Pro Paket · Per box	1,28 m ² 24,40 kg 2 pce
Pro Palette · Per pallet	51,20 m ² 976 kg 40 box
Mindestabgabereinheit · Min. sales unit	P (box)
Berechnungseinheit · Calculation unit	m ²
Preisgruppe · Price group	P110

Artikelnummer · Article number	2834
Warengruppe · Product group	Grundfliese · Basic tile
Werksmaße · Dimensions (mm)	797 x 797 x 9 mm
Farbe · Colour	anthracite
Oberfläche · Finish	matt Belebte Natursteinoptik · matt Fresh natural-stone look
Erzeugnisgruppe	Feinsteinzeug
Material	Porcelain stoneware
Maßeinheit · Unit of measure	m ² 19,06 kg 1,56 pce
Pro Paket · Per box	1,28 m ² 24,40 kg 2 pce
Pro Palette · Per pallet	51,20 m ² 976 kg 40 box
Mindestabgabereinheit · Min. sales unit	P (box)
Berechnungseinheit · Calculation unit	m ²
Preisgruppe · Price group	P110

BOURGOGNA Wohnen · Living



60 x 60 cm
NEW 2023



Artikelnummer · Article number
2632

Warengruppe · Product group
DM20

Werkmaße · Dimensions (mm)
Grundfliese · Basic tile

Farbe · Colour
597 x 597 x 9 mm

Oberfläche · Finish
beige

matt | Belebte Natursteinoptik · matt |
Fresh natural-stone look

VilbstonePlus

Erzeugnisgruppe
Feinsteinzeug

Material
Porcelain stoneware

Maßeinheit · Unit of measure
m² | 19,72 kg | 2,78 pce

Pro Paket · Per box
1,44 m² | 28,40 kg | 4 pce

Pro Palette · Per pallet
43,20 m² | 852 kg | 30 box

Mindestabgabereinheit · Min. sales unit
P (box)

Berechnungseinheit · Calculation unit
m²

Preisgruppe · Price group
P99



60 x 60 cm
NEW 2023



Artikelnummer · Article number
2632

Warengruppe · Product group
DM70

Werkmaße · Dimensions (mm)
Grundfliese · Basic tile

Farbe · Colour
597 x 597 x 9 mm

Oberfläche · Finish
greige

matt | Belebte Natursteinoptik · matt |
Fresh natural-stone look

VilbstonePlus

Erzeugnisgruppe
Feinsteinzeug

Material
Porcelain stoneware

Maßeinheit · Unit of measure
m² | 19,72 kg | 2,78 pce

Pro Paket · Per box
1,44 m² | 28,40 kg | 4 pce

Pro Palette · Per pallet
43,20 m² | 852 kg | 30 box

Mindestabgabereinheit · Min. sales unit
P (box)

Berechnungseinheit · Calculation unit
m²

Preisgruppe · Price group
P99



60 x 60 cm
NEW 2023



Artikelnummer · Article number
2632

Warengruppe · Product group
DM60

Werkmaße · Dimensions (mm)
Grundfliese · Basic tile

Farbe · Colour
597 x 597 x 9 mm

Oberfläche · Finish
grey

matt | Belebte Natursteinoptik · matt |
Fresh natural-stone look

VilbstonePlus

Erzeugnisgruppe
Feinsteinzeug

Material
Porcelain stoneware

Maßeinheit · Unit of measure
m² | 19,72 kg | 2,78 pce

Pro Paket · Per box
1,44 m² | 28,40 kg | 4 pce

Pro Palette · Per pallet
43,20 m² | 852 kg | 30 box

Mindestabgabereinheit · Min. sales unit
P (box)

Berechnungseinheit · Calculation unit
m²

Preisgruppe · Price group
P99



60 x 60 cm
NEW 2023



Artikelnummer · Article number
2632

Warengruppe · Product group
DM90

Werkmaße · Dimensions (mm)
Grundfliese · Basic tile

Farbe · Colour
597 x 597 x 9 mm

Oberfläche · Finish
anthracite

matt | Belebte Natursteinoptik · matt |
Fresh natural-stone look

VilbstonePlus

Erzeugnisgruppe
Feinsteinzeug

Material
Porcelain stoneware

Maßeinheit · Unit of measure
m² | 19,72 kg | 2,78 pce

Pro Paket · Per box
1,44 m² | 28,40 kg | 4 pce

Pro Palette · Per pallet
43,20 m² | 852 kg | 30 box

Mindestabgabereinheit · Min. sales unit
P (box)

Berechnungseinheit · Calculation unit
m²

Preisgruppe · Price group
P99



26 x 34,5 cm
NEW 2023
□ 0,09 m² | 287 x 355 mm

Artikelnummer · Article number
2184

Warengruppe · Product group
DM20

Werkmaße · Dimensions (mm)
Dekor · Decor

Farbe · Colour
284 x 355 x 9 mm

Oberfläche · Finish
beige

matt | Belebte Natursteinoptik · matt |
Fresh natural-stone look

VilbstonePlus

Erzeugnisgruppe
Feinsteinzeug

Material
Porcelain stoneware

Maßeinheit · Unit of measure
m² | 22,85 kg | 11,15 pce

Pro Paket · Per box
0,72 m² | 16,40 kg | 8 pce

Pro Palette · Per pallet
28,70 m² | 656 kg | 40 box

Mindestabgabereinheit · Min. sales unit
P (box)

Berechnungseinheit · Calculation unit
m²

Preisgruppe · Price group
P170



26 x 34,5 cm
NEW 2023
□ 0,09 m² | 287 x 355 mm

Artikelnummer · Article number
2184

Warengruppe · Product group
DM70

Werkmaße · Dimensions (mm)
Dekor · Decor

Farbe · Colour
284 x 355 x 9 mm

Oberfläche · Finish
greige

matt | Belebte Natursteinoptik · matt |
Fresh natural-stone look

VilbstonePlus

Erzeugnisgruppe
Feinsteinzeug

Material
Porcelain stoneware

Maßeinheit · Unit of measure
m² | 22,85 kg | 11,15 pce

Pro Paket · Per box
0,72 m² | 16,40 kg | 8 pce

Pro Palette · Per pallet
28,70 m² | 656 kg | 40 box

Mindestabgabereinheit · Min. sales unit
P (box)

Berechnungseinheit · Calculation unit
m²

Preisgruppe · Price group
P170



26 x 34,5 cm
NEW 2023
□ 0,09 m² | 287 x 355 mm

Artikelnummer · Article number
2184

Warengruppe · Product group
DM60

Werkmaße · Dimensions (mm)
Dekor · Decor

Farbe · Colour
284 x 355 x 9 mm

Oberfläche · Finish
grey

matt | Belebte Natursteinoptik · matt |
Fresh natural-stone look

VilbstonePlus

Erzeugnisgruppe
Feinsteinzeug

Material
Porcelain stoneware

Maßeinheit · Unit of measure
m² | 22,85 kg | 11,15 pce

Pro Paket · Per box
0,72 m² | 16,40 kg | 8 pce

Pro Palette · Per pallet
28,70 m² | 656 kg | 40 box

Mindestabgabereinheit · Min. sales unit
P (box)

Berechnungseinheit · Calculation unit
m²

Preisgruppe · Price group
P170



26 x 34,5 cm
NEW 2023
□ 0,09 m² | 287 x 355 mm

Artikelnummer · Article number
2184

Warengruppe · Product group
DM90

Werkmaße · Dimensions (mm)
Dekor · Decor

Farbe · Colour
284 x 355 x 9 mm

Oberfläche · Finish
anthracite

matt | Belebte Natursteinoptik · matt |
Fresh natural-stone look

VilbstonePlus

Erzeugnisgruppe
Feinsteinzeug

Material
Porcelain stoneware

Maßeinheit · Unit of measure
m² | 22,85 kg | 11,15 pce

Pro Paket · Per box
0,72 m² | 16,40 kg | 8 pce





















Pro Palette · Per pallet
28,70 m² | 656 kg | 40 box

Mindestabgabereinheit · Min. sales unit
P (box)

Berechnungseinheit · Calculation unit
m²

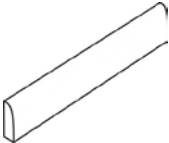
Preisgruppe · Price group
P170

BOURGOGNA Wohnen · Living

				
	7,5 x 7,5 cm NEW 2023 □ 0,09 m ² 297 x 297 mm	7,5 x 7,5 cm NEW 2023 □ 0,09 m ² 297 x 297 mm	7,5 x 7,5 cm NEW 2023 □ 0,09 m ² 297 x 297 mm	7,5 x 7,5 cm NEW 2023 □ 0,09 m ² 297 x 297 mm
Artikelnummer · Article number	2013	2013	2013	2013
Warengruppe · Product group	DM20   	DM70   	DM60   	DM90   
Werkmaße · Dimensions (mm)	Grundfliese · Basic tile 72 x 72 x 9 mm	Grundfliese · Basic tile 72 x 72 x 9 mm	Grundfliese · Basic tile 72 x 72 x 9 mm	Grundfliese · Basic tile 72 x 72 x 9 mm
Farbe · Colour	beige	greige	grey	anthracite
Oberfläche · Finish	matt Belebte Natursteinoptik · matt Fresh natural-stone look	matt Belebte Natursteinoptik · matt Fresh natural-stone look	matt Belebte Natursteinoptik · matt Fresh natural-stone look	matt Belebte Natursteinoptik · matt Fresh natural-stone look
Erzeugnisgruppe	VilbostonePlus	VilbostonePlus	VilbostonePlus	VilbostonePlus
Material	Feinsteinzeug	Feinsteinzeug	Feinsteinzeug	Feinsteinzeug
Maßeinheit · Unit of measure	Porcelain stoneware m ² 20,90 kg 11 pce	Porcelain stoneware m ² 20,90 kg 11 pce	Porcelain stoneware m ² 20,90 kg 11 pce	Porcelain stoneware m ² 20,90 kg 11 pce
Pro Paket · Per box	1 m ² 20,90 kg 11 pce	1 m ² 20,90 kg 11 pce	1 m ² 20,90 kg 11 pce	1 m ² 20,90 kg 11 pce
Pro Palette · Per pallet	36 m ² 752,40 kg 36 box	36 m ² 752,40 kg 36 box	36 m ² 752,40 kg 36 box	36 m ² 752,40 kg 36 box
Mindestabgabeneinheit · Min. sales unit	P (box)	P (box)	P (box)	P (box)
Berechnungseinheit · Calculation unit	m ²	m ²	m ²	m ²
Preisgruppe · Price group	P165	P165	P165	P165
				
	5 x 60 cm NEW 2023			
Artikelnummer · Article number	2875			
Warengruppe · Product group	DM20, DM60, DM70 DM90   			
Werkmaße · Dimensions (mm)	Sockel · Skirting 48 x 597 x 9 mm			
Farbe · Colour	-			
Oberfläche · Finish	matt Belebte Natursteinoptik · matt Fresh natural-stone look			
Erzeugnisgruppe	VilbostonePlus			
Material	Feinsteinzeug			
Maßeinheit · Unit of measure	Porcelain stoneware m 1,05 kg 1,66 pce			
Pro Paket · Per box	9,04 m 9,45 kg 15 pce			
Pro Palette · Per pallet	433,74 m 453,60 kg 48 box			
Mindestabgabeneinheit · Min. sales unit	E (pce)			
Berechnungseinheit · Calculation unit	Stück · piece			
Preisgruppe · Price group	E55			

CÁDIZ *Excellence* by Villeroy & Boch

Concept³

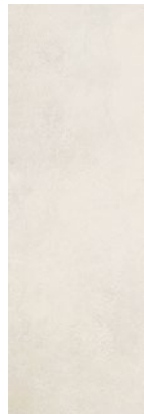

30 x 90 cm



Artikelnummer - Article number	1310
Warengruppe - Product group	Grundfliese - Basic tile
Werksmaße - Dimensions (mm)	297 x 897 x 10 mm
Farbe - Colour	chalk
Oberfläche - Finish	matt Ruhige Kalksteinoptik reliefiert · matt Calm limestone look relief
Erzeugnisgruppe	CeramicPlus
Material	Steingut
Maßeinheit - Unit of measure	Nonvitreous
Pro Paket - Per box	m ² 17,15 kg 3,70 pce
Pro Palette - Per pallet	1,35 m ² 23,15 kg 5 pce
Mindestabgabereinheit - Min. sales unit	32,40 m ² 555,60 kg 27 box
Berechnungseinheit - Calculation unit	P (box)
Preisgruppe - Price group	m ² P105

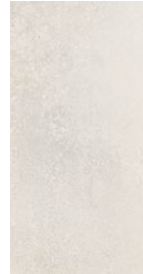

30 x 60 cm



Artikelnummer - Article number	1581
Warengruppe - Product group	Grundfliese - Basic tile
Werksmaße - Dimensions (mm)	297 x 597 x 9 mm
Farbe - Colour	chalk
Oberfläche - Finish	matt Ruhige Kalksteinoptik reliefiert · matt Calm limestone look relief
Erzeugnisgruppe	CeramicPlus
Material	Steingut
Maßeinheit - Unit of measure	Nonvitreous
Pro Paket - Per box	m ² 15,56 kg 5,56 pce
Pro Palette - Per pallet	1,08 m ² 16,80 kg 6 pce
Mindestabgabereinheit - Min. sales unit	51,84 m ² 806,40 kg 48 box
Berechnungseinheit - Calculation unit	P (box)
Preisgruppe - Price group	m ² P87



60 x 60 cm



Artikelnummer - Article number	2570
Warengruppe - Product group	Grundfliese - Basic tile
Werksmaße - Dimensions (mm)	597 x 597 x 10 mm
Farbe - Colour	sand
Oberfläche - Finish	matt Belebte Kalksteinoptik reliefiert · matt Fresh limestone look relief
Erzeugnisgruppe	VilbostonePlus
Material	Feinsteinzeug
Maßeinheit - Unit of measure	Porcelain stoneware
Pro Paket - Per box	m ² 22,22 kg 2,78 pce
Pro Palette - Per pallet	1,44 m ² 32 kg 4 pce
Mindestabgabereinheit - Min. sales unit	43,20 m ² 960 kg 30 box
Berechnungseinheit - Calculation unit	P (box)
Preisgruppe - Price group	m ² P99



60 x 60 cm



Artikelnummer - Article number	2570
Warengruppe - Product group	Grundfliese - Basic tile
Werksmaße - Dimensions (mm)	597 x 597 x 10 mm
Farbe - Colour	chalk
Oberfläche - Finish	matt Belebte Kalksteinoptik reliefiert · matt Fresh limestone look relief
Erzeugnisgruppe	VilbostonePlus
Material	Feinsteinzeug
Maßeinheit - Unit of measure	Porcelain stoneware
Pro Paket - Per box	m ² 22,22 kg 2,78 pce
Pro Palette - Per pallet	1,44 m ² 32 kg 4 pce
Mindestabgabereinheit - Min. sales unit	43,20 m ² 960 kg 30 box
Berechnungseinheit - Calculation unit	P (box)
Preisgruppe - Price group	m ² P99

Auch im Vilbogarden-Sortiment in 20 mm Dicke
Also in 20 mm thicknesses in the Vilbogarden range



60 x 60 cm



Artikelnummer - Article number	2570
Warengruppe - Product group	Grundfliese - Basic tile
Werksmaße - Dimensions (mm)	597 x 597 x 10 mm
Farbe - Colour	chalk multicolor
Oberfläche - Finish	matt Belebte Kalksteinoptik reliefiert · matt Fresh limestone look relief
Erzeugnisgruppe	VilbostonePlus
Material	Feinsteinzeug
Maßeinheit - Unit of measure	Porcelain stoneware
Pro Paket - Per box	m ² 22,22 kg 2,78 pce
Pro Palette - Per pallet	1,44 m ² 32 kg 4 pce
Mindestabgabereinheit - Min. sales unit	43,20 m ² 960 kg 30 box
Berechnungseinheit - Calculation unit	P (box)
Preisgruppe - Price group	m ² P99

Auch im Vilbogarden-Sortiment in 20 mm Dicke
Also in 20 mm thicknesses in the Vilbogarden range



60 x 60 cm



Artikelnummer - Article number	2570
Warengruppe - Product group	Grundfliese - Basic tile
Werksmaße - Dimensions (mm)	597 x 597 x 10 mm
Farbe - Colour	grey multicolor
Oberfläche - Finish	matt Belebte Kalksteinoptik reliefiert · matt Fresh limestone look relief
Erzeugnisgruppe	VilbostonePlus
Material	Feinsteinzeug
Maßeinheit - Unit of measure	Porcelain stoneware
Pro Paket - Per box	m ² 22,22 kg 2,78 pce
Pro Palette - Per pallet	1,44 m ² 32 kg 4 pce
Mindestabgabereinheit - Min. sales unit	43,20 m ² 960 kg 30 box
Berechnungseinheit - Calculation unit	P (box)
Preisgruppe - Price group	m ² P99

Auch im Vilbogarden-Sortiment in 20 mm Dicke
Also in 20 mm thicknesses in the Vilbogarden range

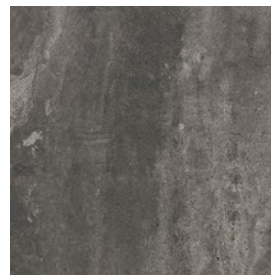

60 x 60 cm



Artikelnummer - Article number	2570
Warengruppe - Product group	Grundfliese - Basic tile
Werksmaße - Dimensions (mm)	597 x 597 x 10 mm
Farbe - Colour	ash grey
Oberfläche - Finish	matt Belebte Kalksteinoptik reliefiert · matt Fresh limestone look relief
Erzeugnisgruppe	VilbostonePlus
Material	Feinsteinzeug
Maßeinheit - Unit of measure	Porcelain stoneware
Pro Paket - Per box	m ² 22,22 kg 2,78 pce
Pro Palette - Per pallet	1,44 m ² 32 kg 4 pce
Mindestabgabereinheit - Min. sales unit	43,20 m ² 960 kg 30 box
Berechnungseinheit - Calculation unit	P (box)
Preisgruppe - Price group	m ² P99

Auch im Vilbogarden-Sortiment in 20 mm Dicke
Also in 20 mm thicknesses in the Vilbogarden range



30 x 60 cm



Artikelnummer - Article number	2572
Warengruppe - Product group	Grundfliese - Basic tile
Werksmaße - Dimensions (mm)	297 x 597 x 10 mm
Farbe - Colour	sand
Oberfläche - Finish	matt Belebte Kalksteinoptik reliefiert · matt Fresh limestone look relief
Erzeugnisgruppe	VilbostonePlus
Material	Feinsteinzeug
Maßeinheit - Unit of measure	Porcelain stoneware
Pro Paket - Per box	m ² 22,22 kg 5,56 pce
Pro Palette - Per pallet	1,08 m ² 24 kg 6 pce
Mindestabgabereinheit - Min. sales unit	43,20 m ² 960 kg 40 box
Berechnungseinheit - Calculation unit	P (box)
Preisgruppe - Price group	m ² P87

Auch im Vilbogarden-Sortiment in 20 mm Dicke
Also in 20 mm thicknesses in the Vilbogarden range

CÁDIZ *Excellence* by Villeroy & Boch

Concept³

	30 x 60 cm	30 x 60 cm	30 x 60 cm	30 x 60 cm
Artikelnummer · Article number	2572	2572	2572	2572
Warengruppe · Product group	BU0M	BU1M	BU7M	BU9M
Werkgröße · Dimensions (mm)	Grundfliese · Basic tile	Grundfliese · Basic tile	Grundfliese · Basic tile	Grundfliese · Basic tile
Farbe · Colour	297 x 597 x 10 mm	297 x 597 x 10 mm	297 x 597 x 10 mm	297 x 597 x 10 mm
Oberfläche · Finish	chalk	chalk multicolor	grey multicolor	ash grey
Erzeugnisgruppe	matt Belebte Kalksteinoptik reliefiert · matt Fresh limestone look relief	matt Belebte Kalksteinoptik reliefiert · matt Fresh limestone look relief	matt Belebte Kalksteinoptik reliefiert · matt Fresh limestone look relief	matt Belebte Kalksteinoptik reliefiert · matt Fresh limestone look relief
Material	VilbostonePlus	VilbostonePlus	VilbostonePlus	VilbostonePlus
Maßeinheit · Unit of measure	Feinsteinzeug	Feinsteinzeug	Feinsteinzeug	Feinsteinzeug
Pro Paket · Per box	Porcelain stoneware	Porcelain stoneware	Porcelain stoneware	Porcelain stoneware
Pro Palette · Per pallet	m ² 22,22 kg 5,56 pce	m ² 22,22 kg 5,56 pce	m ² 22,22 kg 5,56 pce	m ² 22,22 kg 5,56 pce
Mindestabgabeneinheit · Min. sales unit	1,08 m ² 24 kg 6 pce	1,08 m ² 24 kg 6 pce	1,08 m ² 24 kg 6 pce	1,08 m ² 24 kg 6 pce
Berechnungseinheit · Calculation unit	43,20 m ² 960 kg 40 box	43,20 m ² 960 kg 40 box	43,20 m ² 960 kg 40 box	43,20 m ² 960 kg 40 box
Preisgruppe · Price group	P (box)	P (box)	P (box)	P (box)
	m ²	m ²	m ²	m ²
	P87	P87	P87	P87
	10 x 20 cm	10 x 20 cm	10 x 20 cm	10 x 20 cm
Artikelnummer · Article number	2496	2496	2496	2496
Warengruppe · Product group	BU2M	BU0M	BU1M	BU7M
Werkgröße · Dimensions (mm)	Grundfliese · Basic tile	Grundfliese · Basic tile	Grundfliese · Basic tile	Grundfliese · Basic tile
Farbe · Colour	97 x 197 x 10 mm	97 x 197 x 10 mm	97 x 197 x 10 mm	97 x 197 x 10 mm
Oberfläche · Finish	sand	chalk	chalk multicolor	grey multicolor
Erzeugnisgruppe	matt Belebte Kalksteinoptik reliefiert · matt Fresh limestone look relief	matt Belebte Kalksteinoptik reliefiert · matt Fresh limestone look relief	matt Belebte Kalksteinoptik reliefiert · matt Fresh limestone look relief	matt Belebte Kalksteinoptik reliefiert · matt Fresh limestone look relief
Material	VilbostonePlus	VilbostonePlus	VilbostonePlus	VilbostonePlus
Maßeinheit · Unit of measure	Feinsteinzeug	Feinsteinzeug	Feinsteinzeug	Feinsteinzeug
Pro Paket · Per box	Porcelain stoneware	Porcelain stoneware	Porcelain stoneware	Porcelain stoneware
Pro Palette · Per pallet	m ² 21,50 kg 50 pce	m ² 21,50 kg 50 pce	m ² 21,50 kg 50 pce	m ² 21,50 kg 50 pce
Mindestabgabeneinheit · Min. sales unit	0,90 m ² 19,35 kg 45 pce	0,90 m ² 19,35 kg 45 pce	0,90 m ² 19,35 kg 45 pce	0,90 m ² 19,35 kg 45 pce
Berechnungseinheit · Calculation unit	43,20 m ² 928,80 kg 48 box	43,20 m ² 928,80 kg 48 box	43,20 m ² 928,80 kg 48 box	43,20 m ² 928,80 kg 48 box
Preisgruppe · Price group	P (box)	P (box)	P (box)	P (box)
	m ²	m ²	m ²	m ²
	P164	P164	P164	P164
	10 x 20 cm	5 x 10 cm	5 x 10 cm	5 x 10 cm
Artikelnummer · Article number	2496	2037	2037	2037
Warengruppe · Product group	BU9M	BU2M	BU0M	BU1M
Werkgröße · Dimensions (mm)	Grundfliese · Basic tile	Grundfliese · Basic tile	Grundfliese · Basic tile	Grundfliese · Basic tile
Farbe · Colour	97 x 197 x 10 mm	48 x 98 x 10 mm	48 x 98 x 10 mm	48 x 98 x 10 mm
Oberfläche · Finish	ash grey	sand	chalk	chalk multicolor
Erzeugnisgruppe	matt Belebte Kalksteinoptik reliefiert · matt Fresh limestone look relief	matt Belebte Kalksteinoptik reliefiert · matt Fresh limestone look relief	matt Belebte Kalksteinoptik reliefiert · matt Fresh limestone look relief	matt Belebte Kalksteinoptik reliefiert · matt Fresh limestone look relief
Material	VilbostonePlus	VilbostonePlus	VilbostonePlus	VilbostonePlus
Maßeinheit · Unit of measure	Feinsteinzeug	Feinsteinzeug	Feinsteinzeug	Feinsteinzeug
Pro Paket · Per box	Porcelain stoneware	Porcelain stoneware	Porcelain stoneware	Porcelain stoneware
Pro Palette · Per pallet	m ² 21,50 kg 50 pce	m ² 22 kg 11 pce	m ² 22 kg 11 pce	m ² 22 kg 11 pce
Mindestabgabeneinheit · Min. sales unit	0,90 m ² 19,35 kg 45 pce	1 m ² 22 kg 11 pce	1 m ² 22 kg 11 pce	1 m ² 22 kg 11 pce
Berechnungseinheit · Calculation unit	43,20 m ² 928,80 kg 48 box	36 m ² 792 kg 36 box	36 m ² 792 kg 36 box	36 m ² 792 kg 36 box
Preisgruppe · Price group	P (box)	P (box)	P (box)	P (box)
	m ²	m ²	m ²	m ²
	P164	P202	P202	P202
	10 x 20 cm	0,09 m ² 298 x 298 mm	0,09 m ² 298 x 298 mm	0,09 m ² 298 x 298 mm

CÁDIZ *Excellence* by Villeroy & Boch

Concept³

	5 x 10 cm	5 x 10 cm	7,5 x 60 cm
	□ 0,09 m ² 298 x 298 mm	□ 0,09 m ² 298 x 298 mm	
Artikelnummer · Article number	2037	2037	2872
	BU7M	BU9M	BU0M, BU1M, BU2M BU7M, BU9M
Warengruppe · Product group	Grundfliese · Basic tile	Grundfliese · Basic tile	Sockel · Skirting
Werkmaße · Dimensions (mm)	48 x 98 x 10 mm	48 x 98 x 10 mm	72 x 597 x 10 mm
Farbe · Colour	grey multicolor	ash grey	-
Oberfläche · Finish	matt Belebte Kalksteinoptik reliefiert · matt Fresh limestone look relief	matt Belebte Kalksteinoptik reliefiert · matt Fresh limestone look relief	matt Belebte Kalksteinoptik reliefiert · matt Fresh limestone look relief
	VilbostonePlus	VilbostonePlus	VilbostonePlus
Erzeugnisgruppe	Feinsteinzeug	Feinsteinzeug	Feinsteinzeug
Material	Porcelain stoneware	Porcelain stoneware	Porcelain stoneware
Maßeinheit · Unit of measure	m ² 22 kg 11 pce	m ² 22 kg 11 pce	m 1,66 kg 1,66 pce
Pro Paket · Per box	1 m ² 22 kg 11 pce	1 m ² 22 kg 11 pce	12,05 m 20 kg 20 pce
Pro Palette · Per pallet	36 m ² 792 kg 36 box	36 m ² 792 kg 36 box	578,31 m 960 kg 48 box
Mindestabgabereinheit · Min. sales unit	P (box)	P (box)	E (pce)
Berechnungseinheit · Calculation unit	m ²	m ²	Stück · piece
Preisgruppe · Price group	P202	P202	E53

HOUSTON Wohnen Basis · Living Basis

	30 x 60 cm	30 x 60 cm
Artikelnummer · Article number	1571	1571
	RA00	RA10
Warengruppe · Product group	Grundfliese · Basic tile	Grundfliese · Basic tile
Werkmaße · Dimensions (mm)	297 x 597 x 9 mm	297 x 597 x 9 mm
Farbe · Colour	white	beige
Oberfläche · Finish	matt CeramicPlus	matt CeramicPlus
Erzeugnisgruppe	Steingut	Steingut
Material	Nonvitreous	Nonvitreous
Maßeinheit · Unit of measure	m ² 15,56 kg 5,56 pce	m ² 15,56 kg 5,56 pce
Pro Paket · Per box	1,08 m ² 16,80 kg 6 pce	1,08 m ² 16,80 kg 6 pce
Pro Palette · Per pallet	51,84 m ² 806,40 kg 48 box	51,84 m ² 806,40 kg 48 box
Mindestabgabereinheit · Min. sales unit	P (box)	P (box)
Berechnungseinheit · Calculation unit	m ²	m ²
Preisgruppe · Price group	P71	P71

LUCCA Wohnen · Living



60 x 120 cm

Artikelnummer · Article number	2761
Warengruppe · Product group	LS06
Werksmaße · Dimensions (mm)	Grundfliese · Basic tile
Farbe · Colour	597 x 1197 x 10 mm
Oberfläche · Finish	pearl
Erzeugnisgruppe	matt Dezente Steinstruktur reliefiert · matt Subtle stone structure relief
Material	VilbostonePlus
Maßeinheit · Unit of measure	Feinsteinzeug
Pro Paket · Per box	Porcelain stoneware
Pro Palette · Per pallet	m ² 21,28 kg 1,39 pce
Mindestabgabeneinheit · Min. sales unit	1,44 m ² 30,64 kg 2 pce
Berechnungseinheit · Calculation unit	43,2 m ² 919,2 kg 30 box
Preisgruppe · Price group	P (box)
	m ²
	P110



60 x 120 cm

Artikelnummer · Article number	2761
Warengruppe · Product group	LS70
Werksmaße · Dimensions (mm)	Grundfliese · Basic tile
Farbe · Colour	597 x 1197 x 10 mm
Oberfläche · Finish	sand
Erzeugnisgruppe	matt Dezente Steinstruktur reliefiert · matt Subtle stone structure relief
Material	VilbostonePlus
Maßeinheit · Unit of measure	Feinsteinzeug
Pro Paket · Per box	Porcelain stoneware
Pro Palette · Per pallet	m ² 21,28 kg 1,39 pce
Mindestabgabeneinheit · Min. sales unit	1,44 m ² 30,64 kg 2 pce
Berechnungseinheit · Calculation unit	43,2 m ² 919,2 kg 30 box
Preisgruppe · Price group	P (box)
	m ²
	P110



60 x 120 cm

Artikelnummer · Article number	2761
Warengruppe · Product group	LS60
Werksmaße · Dimensions (mm)	Grundfliese · Basic tile
Farbe · Colour	597 x 1197 x 10 mm
Oberfläche · Finish	stone
Erzeugnisgruppe	matt Dezente Steinstruktur reliefiert · matt Subtle stone structure relief
Material	VilbostonePlus
Maßeinheit · Unit of measure	Feinsteinzeug
Pro Paket · Per box	Porcelain stoneware
Pro Palette · Per pallet	m ² 21,28 kg 1,39 pce
Mindestabgabeneinheit · Min. sales unit	1,44 m ² 30,64 kg 2 pce
Berechnungseinheit · Calculation unit	43,2 m ² 919,2 kg 30 box
Preisgruppe · Price group	P (box)
	m ²
	P110



60 x 120 cm

Artikelnummer · Article number	2761
Warengruppe · Product group	LS90
Werksmaße · Dimensions (mm)	Grundfliese · Basic tile
Farbe · Colour	597 x 1197 x 10 mm
Oberfläche · Finish	rock
Erzeugnisgruppe	matt Dezente Steinstruktur reliefiert · matt Subtle stone structure relief
Material	VilbostonePlus
Maßeinheit · Unit of measure	Feinsteinzeug
Pro Paket · Per box	Porcelain stoneware
Pro Palette · Per pallet	m ² 21,28 kg 1,39 pce
Mindestabgabeneinheit · Min. sales unit	1,44 m ² 30,64 kg 2 pce
Berechnungseinheit · Calculation unit	43,2 m ² 919,2 kg 30 box
Preisgruppe · Price group	P (box)
	m ²
	P110



60 x 120 cm

Artikelnummer · Article number	2730
Warengruppe · Product group	LS65
Werksmaße · Dimensions (mm)	Dekor · Decor
Farbe · Colour	597 x 1197 x 10 mm
Oberfläche · Finish	multicolor
Erzeugnisgruppe	matt · matt
Material	Feinsteinzeug glasiert
Maßeinheit · Unit of measure	Glazed porcelain stoneware
Pro Paket · Per box	m ² 21,28 kg 1,39 pce
Pro Palette · Per pallet	1,44 m ² 30,64 kg 2 pce
Mindestabgabeneinheit · Min. sales unit	43,2 m ² 919,2 kg 30 box
Berechnungseinheit · Calculation unit	P (box)
Preisgruppe · Price group	m ²
	P140



60 x 60 cm

Artikelnummer · Article number	2871
Warengruppe · Product group	LS06
Werksmaße · Dimensions (mm)	Grundfliese · Basic tile
Farbe · Colour	597 x 597 x 9 mm
Oberfläche · Finish	pearl
Erzeugnisgruppe	matt Dezente Steinstruktur reliefiert · matt Subtle stone structure relief
Material	VilbostonePlus
Maßeinheit · Unit of measure	Feinsteinzeug
Pro Paket · Per box	Porcelain stoneware
Pro Palette · Per pallet	m ² 22,22 kg 2,78 pce
Mindestabgabeneinheit · Min. sales unit	1,44 m ² 32 kg 4 pce
Berechnungseinheit · Calculation unit	43,20 m ² 960 kg 30 box
Preisgruppe · Price group	P (box)
	m ²
	P99



60 x 60 cm

Artikelnummer · Article number	2871
Warengruppe · Product group	LS70
Werksmaße · Dimensions (mm)	Grundfliese · Basic tile
Farbe · Colour	597 x 597 x 9 mm
Oberfläche · Finish	sand
Erzeugnisgruppe	matt Dezente Steinstruktur reliefiert · matt Subtle stone structure relief
Material	VilbostonePlus
Maßeinheit · Unit of measure	Feinsteinzeug
Pro Paket · Per box	Porcelain stoneware
Pro Palette · Per pallet	m ² 22,22 kg 2,78 pce
Mindestabgabeneinheit · Min. sales unit	1,44 m ² 32 kg 4 pce
Berechnungseinheit · Calculation unit	43,20 m ² 960 kg 30 box
Preisgruppe · Price group	P (box)
	m ²
	P99



60 x 60 cm

Artikelnummer · Article number	2871
Warengruppe · Product group	LS60
Werksmaße · Dimensions (mm)	Grundfliese · Basic tile
Farbe · Colour	597 x 597 x 9 mm
Oberfläche · Finish	stone
Erzeugnisgruppe	matt Dezente Steinstruktur reliefiert · matt Subtle stone structure relief
Material	VilbostonePlus
Maßeinheit · Unit of measure	Feinsteinzeug
Pro Paket · Per box	Porcelain stoneware
Pro Palette · Per pallet	m ² 22,22 kg 2,78 pce
Mindestabgabeneinheit · Min. sales unit	1,44 m ² 32 kg 4 pce
Berechnungseinheit · Calculation unit	43,20 m ² 960 kg 30 box
Preisgruppe · Price group	P (box)
	m ²
	P99

LUCCA Wohnen · Living



60 x 60 cm	60 x 60 cm	45 x 45 cm	15 x 60 cm
2871 LS90	2660 LS06, LS60, LS70 LS90	2733 LS06, LS60, LS70 LS90	2137 LS06
Warengruppe · Product group Werkmaße · Dimensions (mm) Farbe · Colour Oberfläche · Finish	Warengruppe · Product group Werkmaße · Dimensions (mm) Farbe · Colour Oberfläche · Finish	Warengruppe · Product group Werkmaße · Dimensions (mm) Farbe · Colour Oberfläche · Finish	Warengruppe · Product group Werkmaße · Dimensions (mm) Farbe · Colour Oberfläche · Finish
Grundfliese · Basic tile 597 x 597 x 9 mm rock matt Dezente Steinstruktur reliefiert · matt Subtle stone structure relief VilbostonePlus	Grundfliese · Basic tile 597 x 597 x 9 mm - matt Dezente Steinstruktur · matt Subtle stone structure VilbostonePlus	Grundfliese · Basic tile 447 x 447 x 9 mm - matt Dezente Steinstruktur · matt Subtle stone structure VilbostonePlus	Dekor · Decor 147 x 597 x 9 mm pearl matt Dezente Steinstruktur reliefiert · matt Subtle stone structure relief VilbostonePlus
Erzeugnisgruppe Material Maßeinheit · Unit of measure Pro Paket · Per box Pro Palette · Per pallet Mindestabgabeneinheit · Min. sales unit Berechnungseinheit · Calculation unit Preisgruppe · Price group	Erzeugnisgruppe Material Maßeinheit · Unit of measure Pro Paket · Per box Pro Palette · Per pallet Mindestabgabeneinheit · Min. sales unit Berechnungseinheit · Calculation unit Preisgruppe · Price group	Erzeugnisgruppe Material Maßeinheit · Unit of measure Pro Paket · Per box Pro Palette · Per pallet Mindestabgabeneinheit · Min. sales unit Berechnungseinheit · Calculation unit Preisgruppe · Price group	Erzeugnisgruppe Material Maßeinheit · Unit of measure Pro Paket · Per box Pro Palette · Per pallet Mindestabgabeneinheit · Min. sales unit Berechnungseinheit · Calculation unit Preisgruppe · Price group
Feinsteinzeug Porcelain stoneware m ² 22,22 kg 2,78 pce 1,44 m ² 32 kg 4 pce 43,20 m ² 960 kg 30 box P (box) m ² P99	Feinsteinzeug Porcelain stoneware m ² 22,22 kg 2,78 pce 1,44 m ² 32 kg 4 pce 43,20 m ² 960 kg 30 box P (box) m ² P99	Feinsteinzeug Porcelain stoneware m ² 19,75 kg 4,94 pce 1,42 m ² 28 kg 7 pce 36,86 m ² 728 kg 26 box P (box) m ² P79	Feinsteinzeug Porcelain stoneware m ² 22,22 kg 11,11 pce 0,90 m ² 20 kg 10 pce 43,20 m ² 960 kg 48 box P (box) m ² P143
15 x 60 cm	15 x 60 cm	15 x 60 cm	30 x 60 cm
2137 LS70	2137 LS60	2137 LS90	2870 LS06
Warengruppe · Product group Werkmaße · Dimensions (mm) Farbe · Colour Oberfläche · Finish	Warengruppe · Product group Werkmaße · Dimensions (mm) Farbe · Colour Oberfläche · Finish	Warengruppe · Product group Werkmaße · Dimensions (mm) Farbe · Colour Oberfläche · Finish	Warengruppe · Product group Werkmaße · Dimensions (mm) Farbe · Colour Oberfläche · Finish
Dekor · Decor 147 x 597 x 9 mm sand matt Dezente Steinstruktur reliefiert · matt Subtle stone structure relief VilbostonePlus	Dekor · Decor 147 x 597 x 9 mm stone matt Dezente Steinstruktur reliefiert · matt Subtle stone structure relief VilbostonePlus	Dekor · Decor 147 x 597 x 9 mm rock matt Dezente Steinstruktur reliefiert · matt Subtle stone structure relief VilbostonePlus	Grundfliese · Basic tile 297 x 597 x 9 mm pearl matt Dezente Steinstruktur reliefiert · matt Subtle stone structure relief VilbostonePlus
Erzeugnisgruppe Material Maßeinheit · Unit of measure Pro Paket · Per box Pro Palette · Per pallet Mindestabgabeneinheit · Min. sales unit Berechnungseinheit · Calculation unit Preisgruppe · Price group	Erzeugnisgruppe Material Maßeinheit · Unit of measure Pro Paket · Per box Pro Palette · Per pallet Mindestabgabeneinheit · Min. sales unit Berechnungseinheit · Calculation unit Preisgruppe · Price group	Erzeugnisgruppe Material Maßeinheit · Unit of measure Pro Paket · Per box Pro Palette · Per pallet Mindestabgabeneinheit · Min. sales unit Berechnungseinheit · Calculation unit Preisgruppe · Price group	Erzeugnisgruppe Material Maßeinheit · Unit of measure Pro Paket · Per box Pro Palette · Per pallet Mindestabgabeneinheit · Min. sales unit Berechnungseinheit · Calculation unit Preisgruppe · Price group
Feinsteinzeug Porcelain stoneware m ² 22,22 kg 11,11 pce 0,90 m ² 20 kg 10 pce 43,20 m ² 960 kg 48 box P (box) m ² P143	Feinsteinzeug Porcelain stoneware m ² 22,22 kg 11,11 pce 0,90 m ² 20 kg 10 pce 43,20 m ² 960 kg 48 box P (box) m ² P143	Feinsteinzeug Porcelain stoneware m ² 22,22 kg 11,11 pce 0,90 m ² 20 kg 10 pce 43,20 m ² 960 kg 48 box P (box) m ² P143	Feinsteinzeug Porcelain stoneware m ² 22,22 kg 5,56 pce 1,08 m ² 24 kg 6 pce 43,20 m ² 960 kg 40 box P (box) m ² P87
30 x 60 cm	30 x 60 cm	30 x 60 cm	7,5 x 7,5 cm 0,09 m ² 297 x 297 mm
2870 LS70	2870 LS60	2870 LS90	2013 LS06
Warengruppe · Product group Werkmaße · Dimensions (mm) Farbe · Colour Oberfläche · Finish	Warengruppe · Product group Werkmaße · Dimensions (mm) Farbe · Colour Oberfläche · Finish	Warengruppe · Product group Werkmaße · Dimensions (mm) Farbe · Colour Oberfläche · Finish	Warengruppe · Product group Werkmaße · Dimensions (mm) Farbe · Colour Oberfläche · Finish
Grundfliese · Basic tile 297 x 597 x 9 mm sand matt Dezente Steinstruktur reliefiert · matt Subtle stone structure relief VilbostonePlus	Grundfliese · Basic tile 297 x 597 x 9 mm stone matt Dezente Steinstruktur reliefiert · matt Subtle stone structure relief VilbostonePlus	Grundfliese · Basic tile 297 x 597 x 9 mm rock matt Dezente Steinstruktur reliefiert · matt Subtle stone structure relief VilbostonePlus	Grundfliese · Basic tile 72 x 72 x 9 mm pearl matt Dezente Steinstruktur reliefiert · matt Subtle stone structure relief VilbostonePlus
Erzeugnisgruppe Material Maßeinheit · Unit of measure Pro Paket · Per box Pro Palette · Per pallet Mindestabgabeneinheit · Min. sales unit Berechnungseinheit · Calculation unit Preisgruppe · Price group	Erzeugnisgruppe Material Maßeinheit · Unit of measure Pro Paket · Per box Pro Palette · Per pallet Mindestabgabeneinheit · Min. sales unit Berechnungseinheit · Calculation unit Preisgruppe · Price group	Erzeugnisgruppe Material Maßeinheit · Unit of measure Pro Paket · Per box Pro Palette · Per pallet Mindestabgabeneinheit · Min. sales unit Berechnungseinheit · Calculation unit Preisgruppe · Price group	Erzeugnisgruppe Material Maßeinheit · Unit of measure Pro Paket · Per box Pro Palette · Per pallet Mindestabgabeneinheit · Min. sales unit Berechnungseinheit · Calculation unit Preisgruppe · Price group
Feinsteinzeug Porcelain stoneware m ² 22,22 kg 5,56 pce 1,08 m ² 24 kg 6 pce 43,20 m ² 960 kg 40 box P (box) m ² P87	Feinsteinzeug Porcelain stoneware m ² 22,22 kg 5,56 pce 1,08 m ² 24 kg 6 pce 43,20 m ² 960 kg 40 box P (box) m ² P87	Feinsteinzeug Porcelain stoneware m ² 22,22 kg 5,56 pce 1,08 m ² 24 kg 6 pce 43,20 m ² 960 kg 40 box P (box) m ² P87	Feinsteinzeug Porcelain stoneware m ² 20,90 kg 11 pce 1,09 m ² 22,80 kg 12 pce 39,27 m ² 820,80 kg 36 box P (box) m ² P176

LUCCA Wohnen · Living



	7,5 x 7,5 cm	7,5 x 7,5 cm	7,5 x 7,5 cm	5 x 60 cm
	□ 0,09 m ² 297 x 297 mm	□ 0,09 m ² 297 x 297 mm	□ 0,09 m ² 297 x 297 mm	
Artikelnummer · Article number	2013	2013	2013	2875
	LS70	LS60	LS90	LS06, LS60, LS70 LS90
Warengruppe · Product group	Grundfliese · Basic tile	Grundfliese · Basic tile	Grundfliese · Basic tile	Sockel · Skirting
Werkgröße · Dimensions (mm)	72 x 72 x 9 mm	72 x 72 x 9 mm	72 x 72 x 9 mm	48 x 597 x 9 mm
Farbe · Colour	sand	stone	rock	-
Oberfläche · Finish	matt Dezente Steinstruktur reliefiert - matt Subtle stone structure relief	matt Dezente Steinstruktur reliefiert - matt Subtle stone structure relief	matt Dezente Steinstruktur reliefiert - matt Subtle stone structure relief	matt Dezente Steinstruktur reliefiert - matt Subtle stone structure relief
	VilbostonePlus	VilbostonePlus	VilbostonePlus	VilbostonePlus
Erzeugnisgruppe	Feinsteinzeug	Feinsteinzeug	Feinsteinzeug	Feinsteinzeug
Material	Porcelain stoneware	Porcelain stoneware	Porcelain stoneware	Porcelain stoneware
Maßeinheit · Unit of measure	m ² 20,90 kg 11 pce	m ² 20,90 kg 11 pce	m ² 20,90 kg 11 pce	m 1,05 kg 1,66 pce
Pro Paket · Per box	1,09 m ² 22,80 kg 12 pce	1,09 m ² 22,80 kg 12 pce	1,09 m ² 22,80 kg 12 pce	9,04 m 9,45 kg 15 pce
Pro Palette · Per pallet	39,27 m ² 820,80 kg 36 box	39,27 m ² 820,80 kg 36 box	39,27 m ² 820,80 kg 36 box	433,74 m 453,60 kg 48 box
Mindestabgabereinheit · Min. sales unit	P (box)	P (box)	P (box)	E (pce)
Berechnungseinheit · Calculation unit	m ²	m ²	m ²	Stück · piece
Preisgruppe · Price group	P176	P176	P176	E60

MARBLE ARCH *Excellence* by Villeroy & Boch

Concept³

	40 x 120 cm	40 x 120 cm	40 x 120 cm	40 x 120 cm
	□ 2	□ 2	□ 2	□ 2
Artikelnummer · Article number	1440	1440	1440	1440
	MA00	MA20	MA01	MA21
Warengruppe · Product group	Grundfliese · Basic tile	Grundfliese · Basic tile	Dekor · Decor	Dekor · Decor
Werkgröße · Dimensions (mm)	397 x 1197 x 11 mm	397 x 1197 x 11 mm	397 x 1197 x 11 mm	397 x 1197 x 11 mm
Farbe · Colour	magic white	arctic gold	magic white	arctic gold
Oberfläche · Finish	glänzend Marmorstruktur · glossy marble texture	glänzend Marmorstruktur · glossy marble texture	glänzend Marmorstruktur · glossy marble texture	glänzend Marmorstruktur · glossy marble texture
	CeramicPlus	CeramicPlus	CeramicPlus	CeramicPlus
Erzeugnisgruppe	Steingut	Steingut	Steingut	Steingut
Material	Nonvitreous	Nonvitreous	Nonvitreous	Nonvitreous
Maßeinheit · Unit of measure	m ² 19,04 kg 2,08 pce	m ² 19,04 kg 2,08 pce	m ² 19,04 kg 2,08 pce	m ² 19,04 kg 2,08 pce
Pro Paket · Per box	1,44 m ² 27,42 kg 3 pce	1,44 m ² 27,42 kg 3 pce	1,44 m ² 27,42 kg 3 pce	1,44 m ² 27,42 kg 3 pce
Pro Palette · Per pallet	25,92 m ² 493,56 kg 18 box	25,92 m ² 493,56 kg 18 box	25,92 m ² 493,56 kg 18 box	25,92 m ² 493,56 kg 18 box
Mindestabgabereinheit · Min. sales unit	P (box)	P (box)	P (box)	P (box)
Berechnungseinheit · Calculation unit	m ²	m ²	m ²	m ²
Preisgruppe · Price group	P122	P122	P140	P140

MARBLE ARCH *Excellence* by Villeroy & Boch

Concept³



60 x 120 cm

Artikelnummer · Article number	2730
Warengruppe · Product group	MAOP
Werkmaße · Dimensions (mm)	Grundfliese · Basic tile
Farbe · Colour	597 x 1197 x 9 mm
Oberfläche · Finish	magic white
Erzeugnisgruppe	poliert Marmorstruktur · polished marble texture
Material	Feinsteinzeug glasiert
Maßeinheit · Unit of measure	Glazed porcelain stoneware
Pro Paket · Per box	m ² 19,49 kg 1,39 pce
Pro Palette · Per pallet	1,44 m ² 28,06 kg 2 pce
Mindestabgabereinheit · Min. sales unit	43,2 m ² 841,8 kg 30 box
Berechnungseinheit · Calculation unit	P (box)
Preisgruppe · Price group	m ²
	P130

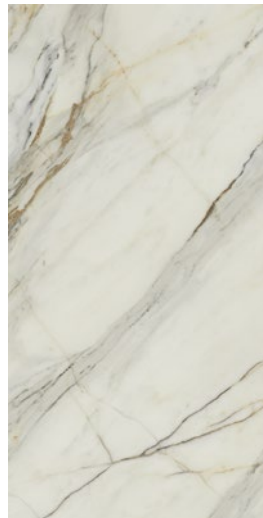

60 x 120 cm

Artikelnummer · Article number	2730
Warengruppe · Product group	MA2P
Werkmaße · Dimensions (mm)	Grundfliese · Basic tile
Farbe · Colour	597 x 1197 x 9 mm
Oberfläche · Finish	arctic gold
Erzeugnisgruppe	poliert Marmorstruktur · polished marble texture
Material	Feinsteinzeug glasiert
Maßeinheit · Unit of measure	Glazed porcelain stoneware
Pro Paket · Per box	m ² 19,49 kg 1,39 pce
Pro Palette · Per pallet	1,44 m ² 28,06 kg 2 pce
Mindestabgabereinheit · Min. sales unit	43,2 m ² 841,8 kg 30 box
Berechnungseinheit · Calculation unit	P (box)
Preisgruppe · Price group	m ²
	P130

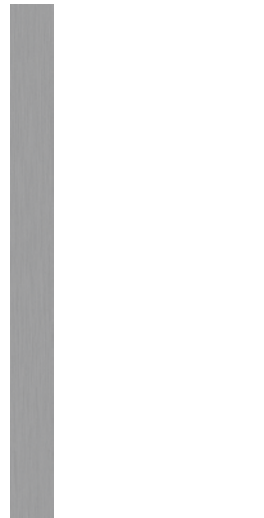

10 x 120 cm

Artikelnummer · Article number	2697
Warengruppe · Product group	MA66
Werkmaße · Dimensions (mm)	Bordüre · Border
Farbe · Colour	97 x 1197 x 10 mm
Oberfläche · Finish	silver
Erzeugnisgruppe	matt Metallic-Optik · matt Metallic-Look
Material	Feinsteinzeug glasiert
Maßeinheit · Unit of measure	Glazed porcelain stoneware
Pro Paket · Per box	m 2,15 kg 0,83 pce
Pro Palette · Per pallet	4,82 m 10,36 kg 4 pce
Mindestabgabereinheit · Min. sales unit	E (pce)
Berechnungseinheit · Calculation unit	Stück · piece
Preisgruppe · Price group	E119

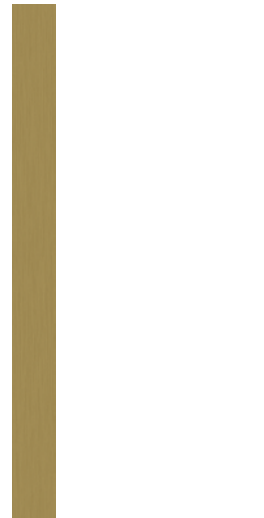

10 x 120 cm

Artikelnummer · Article number	2697
Warengruppe · Product group	MA62
Werkmaße · Dimensions (mm)	Bordüre · Border
Farbe · Colour	97 x 1197 x 10 mm
Oberfläche · Finish	gold
Erzeugnisgruppe	matt Metallic-Optik · matt Metallic-Look
Material	Feinsteinzeug glasiert
Maßeinheit · Unit of measure	Glazed porcelain stoneware
Pro Paket · Per box	m 2,15 kg 0,83 pce
Pro Palette · Per pallet	4,82 m 10,36 kg 4 pce
Mindestabgabereinheit · Min. sales unit	E (pce)
Berechnungseinheit · Calculation unit	Stück · piece
Preisgruppe · Price group	E119

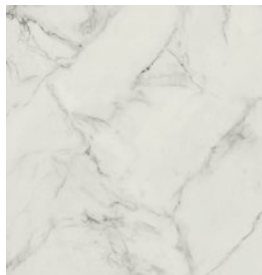

60 x 60 cm

Artikelnummer · Article number	2660
Warengruppe · Product group	MAOP
Werkmaße · Dimensions (mm)	Grundfliese · Basic tile
Farbe · Colour	597 x 597 x 9 mm
Oberfläche · Finish	magic white
Erzeugnisgruppe	poliert Marmorstruktur · polished marble texture
Material	Feinsteinzeug glasiert
Maßeinheit · Unit of measure	Glazed porcelain stoneware
Pro Paket · Per box	m ² 22,22 kg 2,78 pce
Pro Palette · Per pallet	1,44 m ² 32 kg 4 pce
Mindestabgabereinheit · Min. sales unit	43,20 m ² 960 kg 30 box
Berechnungseinheit · Calculation unit	P (box)
Preisgruppe · Price group	m ²
	P130

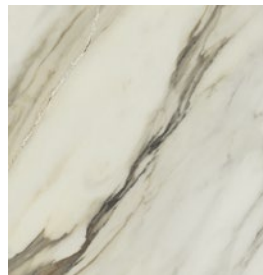

60 x 60 cm

Artikelnummer · Article number	2660
Warengruppe · Product group	MA2P
Werkmaße · Dimensions (mm)	Grundfliese · Basic tile
Farbe · Colour	597 x 597 x 9 mm
Oberfläche · Finish	arctic gold
Erzeugnisgruppe	poliert Marmorstruktur · polished marble texture
Material	Feinsteinzeug glasiert
Maßeinheit · Unit of measure	Glazed porcelain stoneware
Pro Paket · Per box	m ² 22,22 kg 2,78 pce
Pro Palette · Per pallet	1,44 m ² 32 kg 4 pce
Mindestabgabereinheit · Min. sales unit	43,20 m ² 960 kg 30 box
Berechnungseinheit · Calculation unit	P (box)
Preisgruppe · Price group	m ²
	P130



10 x 60 cm

Artikelnummer · Article number	2691
Warengruppe · Product group	MA66
Werkmaße · Dimensions (mm)	Bordüre · Border
Farbe · Colour	97 x 597 x 10 mm
Oberfläche · Finish	silver
Erzeugnisgruppe	matt Metallic-Optik · matt Metallic-Look
Material	Feinsteinzeug glasiert
Maßeinheit · Unit of measure	Glazed porcelain stoneware
Pro Paket · Per box	m 2,16 kg 1,66 pce
Pro Palette · Per pallet	4,22 m 9,10 kg 7 pce
Mindestabgabereinheit · Min. sales unit	E (pce)
Berechnungseinheit · Calculation unit	Stück · piece
Preisgruppe · Price group	E99



10 x 60 cm

Artikelnummer · Article number	2691
Warengruppe · Product group	MA62
Werkmaße · Dimensions (mm)	Bordüre · Border
Farbe · Colour	97 x 597 x 10 mm
Oberfläche · Finish	gold
Erzeugnisgruppe	matt Metallic-Optik · matt Metallic-Look
Material	Feinsteinzeug glasiert
Maßeinheit · Unit of measure	Glazed porcelain stoneware
Pro Paket · Per box	m 2,16 kg 1,66 pce
Pro Palette · Per pallet	4,22 m 9,10 kg 7 pce
Mindestabgabereinheit · Min. sales unit	E (pce)
Berechnungseinheit · Calculation unit	Stück · piece
Preisgruppe · Price group	E99

MARBLE ARCH *Excellence* by Villeroy & Boch

Concept³



4,5 x 10 cm
□ 0,07 m² | 237 x 284 mm

Artikelnummer - Article number	2015
Warengruppe - Product group	MAOP
Dekor - Decor	Dekor - Decor
Werksmaße - Dimensions (mm)	97 x 45 x 9 mm
Farbe - Colour	magic white
Oberfläche - Finish	poliert - polished
Erzeugnisgruppe	Feinsteinzeug glasiert
Material	Glazed porcelain stoneware
Maßeinheit - Unit of measure	m ² 17,05 kg 11 pce
Pro Paket - Per box	0,73 m ² 12,40 kg 8 pce
Pro Palette - Per pallet	56,73 m ² 967,20 kg 78 box
Mindestabgabereinheit - Min. sales unit	P (box)
Berechnungseinheit - Calculation unit	m ²
Preisgruppe - Price group	P190



4,5 x 10 cm
□ 0,07 m² | 237 x 284 mm

Artikelnummer - Article number	2015
Warengruppe - Product group	MA2P
Dekor - Decor	Dekor - Decor
Werksmaße - Dimensions (mm)	97 x 45 x 9 mm
Farbe - Colour	arctic gold
Oberfläche - Finish	poliert - polished
Erzeugnisgruppe	Feinsteinzeug glasiert
Material	Glazed porcelain stoneware
Maßeinheit - Unit of measure	m ² 17,05 kg 11 pce
Pro Paket - Per box	0,73 m ² 12,40 kg 8 pce
Pro Palette - Per pallet	56,73 m ² 967,20 kg 78 box
Mindestabgabereinheit - Min. sales unit	P (box)
Berechnungseinheit - Calculation unit	m ²
Preisgruppe - Price group	P190

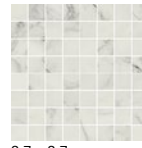

3,7 x 3,7 cm
□ 0,09 m² | 298 x 298 mm

Artikelnummer - Article number	2005
Warengruppe - Product group	MAOP
Dekor - Decor	Grundfliese - Basic tile
Werksmaße - Dimensions (mm)	35,50 x 35,50 x 9 mm
Farbe - Colour	magic white
Oberfläche - Finish	poliert - polished
Erzeugnisgruppe	Feinsteinzeug glasiert
Material	Glazed porcelain stoneware
Maßeinheit - Unit of measure	m ² 22 kg 11 pce
Pro Paket - Per box	0,73 m ² 16 kg 8 pce
Pro Palette - Per pallet	26,18 m ² 576 kg 36 box
Mindestabgabereinheit - Min. sales unit	P (box)
Berechnungseinheit - Calculation unit	m ²
Preisgruppe - Price group	P194

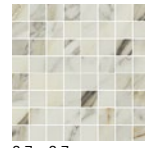

3,7 x 3,7 cm
□ 0,09 m² | 298 x 298 mm

Artikelnummer - Article number	2005
Warengruppe - Product group	MA2P
Dekor - Decor	Grundfliese - Basic tile
Werksmaße - Dimensions (mm)	35,50 x 35,50 x 9 mm
Farbe - Colour	arctic gold
Oberfläche - Finish	poliert - polished
Erzeugnisgruppe	Feinsteinzeug glasiert
Material	Glazed porcelain stoneware
Maßeinheit - Unit of measure	m ² 22 kg 11 pce
Pro Paket - Per box	0,73 m ² 16 kg 8 pce
Pro Palette - Per pallet	26,18 m ² 576 kg 36 box
Mindestabgabereinheit - Min. sales unit	P (box)
Berechnungseinheit - Calculation unit	m ²
Preisgruppe - Price group	P194



20 x 120 cm

Artikelnummer - Article number	2794
Warengruppe - Product group	MA90
Dekor - Decor	Grundfliese - Basic tile
Werksmaße - Dimensions (mm)	197 x 1197 x 10 mm
Farbe - Colour	dark mocca
Oberfläche - Finish	matt reliefiert - matt relief
Erzeugnisgruppe	VilbostonePlus
Material	Feinsteinzeug
Material	Porcelain stoneware
Maßeinheit - Unit of measure	m ² 22,50 kg 4,17 pce
Pro Paket - Per box	0,96 m ² 21,60 kg 4 pce
Pro Palette - Per pallet	29,76 m ² 669,60 kg 31 box
Mindestabgabereinheit - Min. sales unit	P (box)
Berechnungseinheit - Calculation unit	m ²
Preisgruppe - Price group	P124



20 x 120 cm

Artikelnummer - Article number	2794
Warengruppe - Product group	MA80
Dekor - Decor	Grundfliese - Basic tile
Werksmaße - Dimensions (mm)	197 x 1197 x 10 mm
Farbe - Colour	golden honey
Oberfläche - Finish	matt reliefiert - matt relief
Erzeugnisgruppe	VilbostonePlus
Material	Feinsteinzeug
Material	Porcelain stoneware
Maßeinheit - Unit of measure	m ² 22,50 kg 4,17 pce
Pro Paket - Per box	0,96 m ² 21,60 kg 4 pce
Pro Palette - Per pallet	29,76 m ² 669,60 kg 31 box
Mindestabgabereinheit - Min. sales unit	P (box)
Berechnungseinheit - Calculation unit	m ²
Preisgruppe - Price group	P124



60 x 120 cm

Artikelnummer - Article number	2756
Warengruppe - Product group	MA90
Dekor - Decor	Dekor - Decor
Werksmaße - Dimensions (mm)	597 x 1197 x 9 mm
Farbe - Colour	dark mocca
Oberfläche - Finish	matt reliefiert - matt relief
Erzeugnisgruppe	VilbostonePlus
Material	Feinsteinzeug
Material	Porcelain stoneware
Maßeinheit - Unit of measure	m ² 19,49 kg 1,39 pce
Pro Paket - Per box	1,44 m ² 28,06 kg 2 pce
Pro Palette - Per pallet	43,2 m ² 841,8 kg 30 box
Mindestabgabereinheit - Min. sales unit	P (box)
Berechnungseinheit - Calculation unit	m ²
Preisgruppe - Price group	P140



60 x 120 cm

Artikelnummer - Article number	2756
Warengruppe - Product group	MA80
Dekor - Decor	Dekor - Decor
Werksmaße - Dimensions (mm)	597 x 1197 x 9 mm
Farbe - Colour	golden honey
Oberfläche - Finish	matt reliefiert - matt relief
Erzeugnisgruppe	VilbostonePlus
Material	Feinsteinzeug
Material	Porcelain stoneware
Maßeinheit - Unit of measure	m ² 19,49 kg 1,39 pce
Pro Paket - Per box	1,44 m ² 28,06 kg 2 pce
Pro Palette - Per pallet	43,2 m ² 841,8 kg 30 box
Mindestabgabereinheit - Min. sales unit	P (box)
Berechnungseinheit - Calculation unit	m ²
Preisgruppe - Price group	P140

MARBLE ARCH *Excellence* by Villeroy & Boch

Concept³



60 x 60 cm



60 x 60 cm

Artikelnummer · Article number	2658	2658
Warengruppe · Product group	MA90	MA80
Werkmaße · Dimensions (mm)	Dekor · Decor 597 x 597 x 9 mm	Dekor · Decor 597 x 597 x 9 mm
Farbe · Colour	dark mocca	golden honey
Oberfläche · Finish	matt reliefiert · matt relief VilbostonePlus	matt reliefiert · matt relief VilbostonePlus
Erzeugnisgruppe	Feinsteinzeug	Feinsteinzeug
Material	Porcelain stoneware	Porcelain stoneware
Maßeinheit · Unit of measure	m ² 22,22 kg 2,78 pce	m ² 22,22 kg 2,78 pce
Pro Paket · Per box	1,44 m ² 32 kg 4 pce	1,44 m ² 32 kg 4 pce
Pro Palette · Per pallet	43,20 m ² 960 kg 30 box	43,20 m ² 960 kg 30 box
Mindestabgabereinheit · Min. sales unit	P (box)	P (box)
Berechnungseinheit · Calculation unit	m ²	m ²
Preisgruppe · Price group	P134	P134

MARMOCHIC *Excellence* by Villeroy & Boch

Concept³



40 x 120 cm



40 x 120 cm

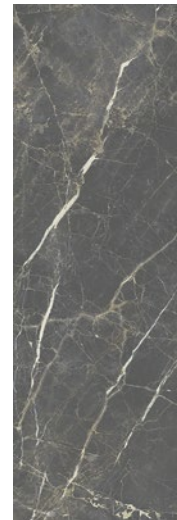











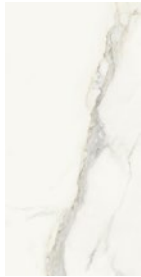

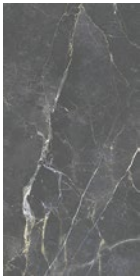











40 x 120 cm



Artikelnummer · Article number	1516	1516	1516
Warengruppe · Product group	MR00	MR60	MR90
Werkmaße · Dimensions (mm)	Grundfliese · Basic tile 397 x 1197 x 11 mm	Grundfliese · Basic tile 397 x 1197 x 9 mm	Grundfliese · Basic tile 397 x 1197 x 9 mm
Farbe · Colour	essential white	deep pearl	dark illusion
Oberfläche · Finish	glänzend · glossy CeramicPlus	glänzend · glossy CeramicPlus	glänzend · glossy CeramicPlus
Erzeugnisgruppe	Steingut	Steingut	Steingut
Material	Nonvitreous	Nonvitreous	Nonvitreous
Maßeinheit · Unit of measure	m ² 19,04 kg 2,08 pce	m ² 19,04 kg 2,08 pce	m ² 19,04 kg 2,08 pce
Pro Paket · Per box	1,44 m ² 27,42 kg 3 pce	1,44 m ² 27,42 kg 3 pce	1,44 m ² 27,42 kg 3 pce
Pro Palette · Per pallet	25,92 m ² 493,56 kg 18 box	25,92 m ² 493,56 kg 18 box	25,92 m ² 493,56 kg 18 box
Mindestabgabereinheit · Min. sales unit	P (box)	P (box)	P (box)
Berechnungseinheit · Calculation unit	m ²	m ²	m ²
Preisgruppe · Price group	P122	P122	P122









MARMOCHIC *Excellence* by Villeroy & Boch

Concept³

				
	30 x 60 cm 	30 x 60 cm 	30 x 60 cm 	
Artikelnummer · Article number	1511	1511	1511	
MR00				
Warengruppe · Product group	Grundfliese · Basic tile	Grundfliese · Basic tile	Grundfliese · Basic tile	
Werkgröße · Dimensions (mm)	297 x 597 x 9 mm	297 x 597 x 9 mm	297 x 597 x 9 mm	
Farbe · Colour	essential white	deep pearl	dark illusion	
Oberfläche · Finish	glänzend · glossy CeramicPlus	glänzend · glossy CeramicPlus	glänzend · glossy CeramicPlus	
Erzeugnisgruppe	Steingut	Steingut	Steingut	
Material	Nonvitreous	Nonvitreous	Nonvitreous	
Maßeinheit · Unit of measure	m ² 15,57 kg 5,56 pce	m ² 15,57 kg 5,56 pce	m ² 15,57 kg 5,56 pce	
Pro Paket · Per box	1,62 m ² 25,20 kg 9 pce	1,62 m ² 25,20 kg 9 pce	1,62 m ² 25,20 kg 9 pce	
Pro Palette · Per pallet	51,80 m ² 806,40 kg 32 box	51,80 m ² 806,40 kg 32 box	51,80 m ² 806,40 kg 32 box	
Mindestabgabereinheit · Min. sales unit	P (box)	P (box)	P (box)	
Berechnungseinheit · Calculation unit	m ²	m ²	m ²	
Preisgruppe · Price group	P99	P99	P99	
				
	5 x 30 cm	5 x 30 cm	5 x 30 cm	9 x 30 cm
Artikelnummer · Article number	1050	1050	1050	1051
MR00				
Warengruppe · Product group	Bordüre · Border	Bordüre · Border	Bordüre · Border	Bordüre · Border
Werkgröße · Dimensions (mm)	50 x 297 x 9 mm	50 x 297 x 9 mm	50 x 297 x 9 mm	90 x 297 x 9 mm
Farbe · Colour	essential white	deep pearl	dark illusion	essential white
Oberfläche · Finish	glänzend reliefiert · glossy relief CeramicPlus	glänzend reliefiert · glossy relief CeramicPlus	glänzend reliefiert · glossy relief CeramicPlus	glänzend reliefiert · glossy relief CeramicPlus
Erzeugnisgruppe	Steingut	Steingut	Steingut	Steingut
Material	Nonvitreous	Nonvitreous	Nonvitreous	Nonvitreous
Maßeinheit · Unit of measure	m 0,90 kg 3,33 pce	m 0,90 kg 3,33 pce	m 0,90 kg 3,33 pce	m 1,56 kg 3,39 pce
Pro Paket · Per box	1,80 m 1,62 kg 6 pce	1,80 m 1,62 kg 6 pce	1,80 m 1,62 kg 6 pce	1,77 m 2,76 kg 6 pce
Pro Palette · Per pallet	-	-	-	-
Mindestabgabereinheit · Min. sales unit	E (pce)	E (pce)	E (pce)	E (pce)
Berechnungseinheit · Calculation unit	Stück · piece	Stück · piece	Stück · piece	Stück · piece
Preisgruppe · Price group	E64	E64	E64	E82
				
	9 x 30 cm	9 x 30 cm	26 x 30 cm	26 x 30 cm
Artikelnummer · Article number	1051	1051	1052	1052
MR60				
Warengruppe · Product group	Bordüre · Border	Bordüre · Border	Sockel · Skirting	Sockel · Skirting
Werkgröße · Dimensions (mm)	90 x 297 x 9 mm	90 x 297 x 9 mm	250 x 297 x 9 mm	250 x 297 x 9 mm
Farbe · Colour	deep pearl	dark illusion	essential white	deep pearl
Oberfläche · Finish	glänzend reliefiert · glossy relief CeramicPlus	glänzend reliefiert · glossy relief CeramicPlus	glänzend reliefiert · glossy relief CeramicPlus	glänzend reliefiert · glossy relief CeramicPlus
Erzeugnisgruppe	Steingut	Steingut	Steingut	Steingut
Material	Nonvitreous	Nonvitreous	Nonvitreous	Nonvitreous
Maßeinheit · Unit of measure	m 1,56 kg 3,39 pce	m 1,56 kg 3,39 pce	m 4,07 kg 3,39 pce	m 4,07 kg 3,39 pce
Pro Paket · Per box	1,77 m 2,76 kg 6 pce	1,77 m 2,76 kg 6 pce	1,77 m 7,20 kg 6 pce	1,77 m 7,20 kg 6 pce
Pro Palette · Per pallet	-	-	79,65 m 324 kg 45 box	79,65 m 324 kg 45 box
Mindestabgabereinheit · Min. sales unit	E (pce)	E (pce)	E (pce)	E (pce)
Berechnungseinheit · Calculation unit	Stück · piece	Stück · piece	Stück · piece	Stück · piece
Preisgruppe · Price group	E82	E82	E100	E100

MARMOCHIC *Excellence* by Villeroy & Boch

Concept³

			
26 x 30 cm	1,8 x 4,2 cm □ 0,09 m ² 298 x 298 mm	1,8 x 4,2 cm □ 0,09 m ² 298 x 298 mm	1,8 x 4,2 cm □ 0,09 m ² 298 x 298 mm
1052	1701	1701	1701
MR90	MR00	MR60	MR90
Sockel · Skirting	Dekor · Decor	Dekor · Decor	Dekor · Decor
250 x 297 x 9 mm	16,75 x 40,80 x 10 mm	16,75 x 40,80 x 10 mm	16,75 x 40,80 x 10 mm
dark illusion	essential white	deep pearl	dark illusion
glänzend reliefiert · glossy relief	glänzend · glossy	glänzend · glossy	glänzend · glossy
CeramicPlus	CeramicPlus	CeramicPlus	CeramicPlus
Steingut	Steingut	Steingut	Steingut
Nonvitreous	Nonvitreous	Nonvitreous	Nonvitreous
m 4,07 kg 3,39 pce	m ² 19,28 kg 11,34 pce	m ² 19,28 kg 11,34 pce	m ² 19,28 kg 11,34 pce
1,77 m 7,20 kg 6 pce	0,97 m ² 18,70 kg 11 pce	0,97 m ² 18,70 kg 11 pce	0,97 m ² 18,70 kg 11 pce
79,65 m 324 kg 45 box	34,92 m ² 673,20 kg 36 box	34,92 m ² 673,20 kg 36 box	34,92 m ² 673,20 kg 36 box
E (pce)	P (box)	P (box)	P (box)
Stück · piece	m ²	m ²	m ²
E100	P200	P200	P200
			
1,8 x 4,2 cm □ 0,08 m ² 277 x 298 mm	1,8 x 4,2 cm □ 0,08 m ² 277 x 298 mm	2 x 120 cm	2 x 120 cm
1056	1056	1048	1048
MR06	MR09	MR02	MR62
Dekor · Decor	Dekor · Decor	Bordüre · Border	Bordüre · Border
16,75 x 40,80 x 10 mm	16,75 x 40,80 x 10 mm	20 x 1197 x 9 mm	20 x 1197 x 9 mm
essential white · deep pearl · essential white	essential white · dark illusion · essential white	gold · essential white	gold · deep pearl
glänzend · glossy	glänzend · glossy	glänzend · glossy	glänzend · glossy
CeramicPlus	CeramicPlus	CeramicPlus	CeramicPlus
Steingut	Steingut	Steingut/Messing	Steingut/Messing
Nonvitreous	Nonvitreous	Nonvitreous/Brass	Nonvitreous/Brass
m ² 21,79 kg 12,82 pce	m ² 21,79 kg 12,82 pce	m 0,36 kg 0,83 pce	m 0,36 kg 0,83 pce
0,86 m ² 18,70 kg 11 pce	0,86 m ² 18,70 kg 11 pce	2,41 m 0,86 kg 2 pce	2,41 m 0,86 kg 2 pce
30,89 m ² 673,20 kg 36 box	30,89 m ² 673,20 kg 36 box	-	-
P (box)	P (box)	E (pce)	E (pce)
m ²	m ²	Stück · piece	Stück · piece
P204	P204	E74	E74

Bordüre für Wandanwendungen, nicht für Außen- und Naßbereiche geeignet.
Border for wall applications, not suitable for outdoor and wet areas.

Bordüre für Wandanwendungen, nicht für Außen- und Naßbereiche geeignet.
Border for wall applications, not suitable for outdoor and wet areas.









MARMOCHIC *Excellence* by Villeroy & Boch

Concept³

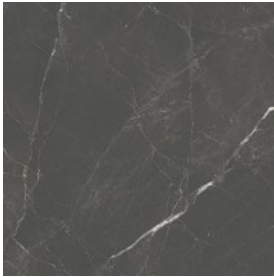
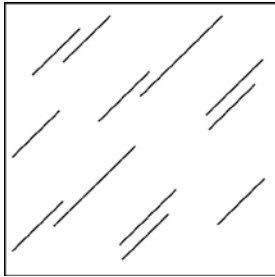
	2 x 120 cm	2 x 120 cm	2 x 120 cm	2 x 120 cm
Artikelnummer · Article number	1048	1049	1049	1049
	MR92	MR06	MR66	MR96
Warengruppe · Product group	Bordüre · Border	Bordüre · Border	Bordüre · Border	Bordüre · Border
Werkmaße · Dimensions (mm)	20 x 1197 x 9 mm	20 x 1197 x 9 mm	20 x 1197 x 9 mm	20 x 1197 x 9 mm
Farbe · Colour	gold - dark illusion	silver - essential white	silver - deep pearl	silver - dark illusion
Oberfläche · Finish	glänzend · glossy CeramicPlus	glänzend · glossy CeramicPlus	glänzend · glossy CeramicPlus	glänzend · glossy CeramicPlus
Erzeugnisgruppe	Steingut/Messing	Steingut/Aluminium	Steingut/Aluminium	Steingut/Aluminium
Material	Nonvitreous/Brass	Nonvitreous/Aluminium	Nonvitreous/Aluminium	Nonvitreous/Aluminium
Maßeinheit · Unit of measure	m 0,36 kg 0,83 pce	m 0,36 kg 0,83 pce	m 0,36 kg 0,83 pce	m 0,36 kg 0,83 pce
Pro Paket · Per box	2,41 m 0,86 kg 2 pce	2,41 m 0,86 kg 2 pce	2,41 m 0,86 kg 2 pce	2,41 m 0,86 kg 2 pce
Pro Palette · Per pallet	-	-	-	-
Mindestabgabereinheit · Min. sales unit	E (pce)	E (pce)	E (pce)	E (pce)
Berechnungseinheit · Calculation unit	Stück · piece	Stück · piece	Stück · piece	Stück · piece
Preisgruppe · Price group	E74	E74	E74	E74
Bordüre für Wandanwendungen, nicht für Außen- und Naßbereiche geeignet. Border for wall applications, not suitable for outdoor and wet areas.				
	60,5 x 120,5 cm	60,5 x 120,5 cm	60,5 x 120,5 cm	60,5 x 120,5 cm
Artikelnummer · Article number	2730	2730	2730	2730
	MR0M	MR6M	MR9M	MR0P, MR9P
Warengruppe · Product group	Grundfliese · Basic tile	Grundfliese · Basic tile	Grundfliese · Basic tile	Grundfliese · Basic tile
Werkmaße · Dimensions (mm)	600 x 1200 x 11 mm	600 x 1200 x 11 mm	600 x 1200 x 11 mm	600 x 1200 x 11 mm
Farbe · Colour	essential white	deep pearl	dark illusion	-
Oberfläche · Finish	matt	matt	matt	poliert · polished
Erzeugnisgruppe	Feinsteinzeug glasiert	Feinsteinzeug glasiert	Feinsteinzeug glasiert	Feinsteinzeug glasiert
Material	Glazed porcelain stoneware	Glazed porcelain stoneware	Glazed porcelain stoneware	Glazed porcelain stoneware
Maßeinheit · Unit of measure	m ² 21,95 kg 1,37 pce	m ² 21,95 kg 1,37 pce	m ² 21,95 kg 1,37 pce	m ² 21,95 kg 1,37 pce
Pro Paket · Per box	1,46 m ² 32 kg 2 pce	1,46 m ² 32 kg 2 pce	1,46 m ² 32 kg 2 pce	1,46 m ² 32 kg 2 pce
Pro Palette · Per pallet	39,36 m ² 864 kg 27 box	39,36 m ² 864 kg 27 box	39,36 m ² 864 kg 27 box	39,36 m ² 864 kg 27 box
Mindestabgabereinheit · Min. sales unit	P (box)	P (box)	P (box)	P (box)
Berechnungseinheit · Calculation unit	m ²	m ²	m ²	m ²
Preisgruppe · Price group	P124	P124	P124	P139

MARMOCHIC *Excellence* by Villeroy & Boch

Concept³

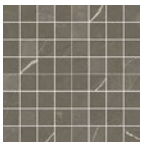
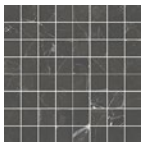
				
	60 x 60 cm	60 x 60 cm	60 x 60 cm	60 x 60 cm
Artikelnummer · Article number	2660	2660	2660	2660
Warengruppe · Product group	MR0M	MR6M	MR9M	MR0P
Werkmaße · Dimensions (mm)	598 x 598 x 10 mm	598 x 598 x 10 mm	598 x 598 x 10 mm	598 x 598 x 10 mm
Farbe · Colour	essential white	deep pearl	dark illusion	-
Oberfläche · Finish	matt	matt	matt	poliert · polished
Erzeugnisgruppe	Feinsteinzeug glasiert	Feinsteinzeug glasiert	Feinsteinzeug glasiert	Feinsteinzeug glasiert
Material	Glazed porcelain stoneware	Glazed porcelain stoneware	Glazed porcelain stoneware	Glazed porcelain stoneware
Maßeinheit · Unit of measure	m ² 21,94 kg 2,78 pce	m ² 21,94 kg 2,78 pce	m ² 21,94 kg 2,78 pce	m ² 21,94 kg 2,78 pce
Pro Paket · Per box	1,44 m ² 31,60 kg 4 pce	1,44 m ² 31,60 kg 4 pce	1,44 m ² 31,60 kg 4 pce	1,44 m ² 31,60 kg 4 pce
Pro Palette · Per pallet	43,20 m ² 948 kg 30 box	43,20 m ² 948 kg 30 box	43,20 m ² 948 kg 30 box	43,20 m ² 948 kg 30 box
Mindestabgabereinheit · Min. sales unit	P (box)	P (box)	P (box)	P (box)
Berechnungseinheit · Calculation unit	m ²	m ²	m ²	m ²
Preisgruppe · Price group	P122	P122	P122	P130
				
	5 x 5 cm	5 x 60 cm	1,8 x 4,2 cm	1,8 x 4,2 cm
			□ 0,08 m ² 270 x 288 mm	□ 0,08 m ² 270 x 288 mm
Artikelnummer · Article number	2019	2025	2006	2006
Warengruppe · Product group	MR0P	MR9P	MR0P	MR6P
Werkmaße · Dimensions (mm)	45 x 45 x 10 mm	45 x 598 x 10 mm	16,75 x 40,80 x 10 mm	16,75 x 40,80 x 10 mm
Farbe · Colour	essential white	dark illusion	essential white	deep pearl
Oberfläche · Finish	poliert · polished	poliert · polished	glänzend · glossy	glänzend · glossy
Erzeugnisgruppe	Feinsteinzeug glasiert	Feinsteinzeug glasiert	Feinsteinzeug glasiert	Feinsteinzeug glasiert
Material	Glazed porcelain stoneware	Glazed porcelain stoneware	Glazed porcelain stoneware	Glazed porcelain stoneware
Maßeinheit · Unit of measure	pce 0,05 kg 1 pce	m 1,17 kg 1,67 pce	m ² 25,72 kg 12,86 pce	m ² 25,72 kg 12,86 pce
Pro Paket · Per box	30 pce 1,50 kg 30 pce	5,99 m 7 kg 10 pce	0,86 m ² 22 kg 11 pce	0,86 m ² 22 kg 11 pce
Pro Palette · Per pallet	-	-	30,79 m ² 792 kg 36 box	30,79 m ² 792 kg 36 box
Mindestabgabereinheit · Min. sales unit	E (pce)	E (pce)	P (box)	P (box)
Berechnungseinheit · Calculation unit	Stück · piece	Stück · piece	m ²	m ²
Preisgruppe · Price group	E15	E33	P204	P204
				
	1,8 x 4,2 cm	3,5 x 3,5 cm	3,5 x 3,5 cm	3,5 x 3,5 cm
	□ 0,08 m ² 270 x 288 mm	□ 0,09 m ² 298 x 298 mm	□ 0,09 m ² 298 x 298 mm	□ 0,09 m ² 298 x 298 mm
Artikelnummer · Article number	2006	2005	2005	2005
Warengruppe · Product group	MR9P	MR0M	MR6M	MR9M
Werkmaße · Dimensions (mm)	16,75 x 40,80 x 10 mm	35,50 x 35,50 x 10 mm	35,50 x 35,50 x 10 mm	35,50 x 35,50 x 10 mm
Farbe · Colour	dark illusion	essential white	deep pearl	dark illusion
Oberfläche · Finish	glänzend · glossy	matt	matt	matt
Erzeugnisgruppe	Feinsteinzeug glasiert	Feinsteinzeug glasiert	Feinsteinzeug glasiert	Feinsteinzeug glasiert
Material	Glazed porcelain stoneware	Glazed porcelain stoneware	Glazed porcelain stoneware	Glazed porcelain stoneware
Maßeinheit · Unit of measure	m ² 25,72 kg 12,86 pce	m ² 22,52 kg 11,26 pce	m ² 22,52 kg 11,26 pce	m ² 22,52 kg 11,26 pce
Pro Paket · Per box	0,86 m ² 22 kg 11 pce	0,98 m ² 22 kg 11 pce	0,98 m ² 22 kg 11 pce	0,98 m ² 22 kg 11 pce
Pro Palette · Per pallet	30,79 m ² 792 kg 36 box	35,17 m ² 792 kg 36 box	35,17 m ² 792 kg 36 box	35,17 m ² 792 kg 36 box
Mindestabgabereinheit · Min. sales unit	P (box)	P (box)	P (box)	P (box)
Berechnungseinheit · Calculation unit	m ²	m ²	m ²	m ²
Preisgruppe · Price group	P204	P196	P196	P196

MARMOCHIC *Excellence* by Villeroy & Boch

Concept³

	0,5 x 120 cm	0,5 x 120 cm	7,5 x 60 cm	7,5 x 60 cm
Artikelnummer · Article number	2027	2027	2872	2872
	MR22	MR66	MR0M, MR6M, MR9M	MR0P, MR6P, MR9P
Warengruppe · Product group	Bordüre · Border	Bordüre · Border	Sockel · Skirting	Sockel · Skirting
Werkmaße · Dimensions (mm)	5 x 1200 x 10 mm	5 x 1200 x 10 mm	72 x 598 x 10 mm	72 x 598 x 10 mm
Farbe · Colour	messing	silver	-	-
Oberfläche · Finish	gebürstet · brushed	gebürstet · brushed	matt	poliert · polished
Erzeugnisgruppe	Metall	Metall	Feinsteinzeug glasiert	Feinsteinzeug glasiert
Material	metal	metal	Glazed porcelain stoneware	Glazed porcelain stoneware
Maßeinheit · Unit of measure	m 0,22 kg 0,83 pce	m 0,22 kg 0,83 pce	m 1,64 kg 1,67 pce	m 1,64 kg 1,67 pce
Pro Paket · Per box	12,05 m 2,70 kg 10 pce	12,05 m 2,70 kg 10 pce	8,98 m 14,70 kg 15 pce	8,98 m 14,70 kg 15 pce
Pro Palette · Per pallet	-	-	431,14 m 705,60 kg 48 box	431,14 m 705,60 kg 48 box
Mindestabgabereinheit · Min. sales unit	E (pce)	E (pce)	E (pce)	E (pce)
Berechnungseinheit · Calculation unit	Stück · piece	Stück · piece	Stück · piece	Stück · piece
Preisgruppe · Price group	E82	E82	E51	E60

MELROSE Wohnen · Living

	30 x 60 cm	30 x 60 cm	30 x 60 cm	30 x 60 cm
Artikelnummer · Article number	1581	1581	1581	1581
	NW00	NW01	NW02	NW03
Warengruppe · Product group	Grundfliese · Basic tile	Grundfliese · Basic tile	Grundfliese · Basic tile	Grundfliese · Basic tile
Werkmaße · Dimensions (mm)	297 x 597 x 9 mm	297 x 597 x 9 mm	297 x 597 x 9 mm	297 x 597 x 9 mm
Farbe · Colour	weiß · white	weiß · white	natur · nature	natur · nature
Oberfläche · Finish	glänzend · glossy CeramicPlus	matt CeramicPlus	glänzend · glossy CeramicPlus	matt CeramicPlus
Erzeugnisgruppe	Steingut	Steingut	Steingut	Steingut
Material	Nonvitreous	Nonvitreous	Nonvitreous	Nonvitreous
Maßeinheit · Unit of measure	m ² 15,56 kg 5,56 pce	m ² 15,56 kg 5,56 pce	m ² 15,56 kg 5,56 pce	m ² 15,56 kg 5,56 pce
Pro Paket · Per box	1,08 m ² 16,80 kg 6 pce	1,08 m ² 16,80 kg 6 pce	1,08 m ² 16,80 kg 6 pce	1,08 m ² 16,80 kg 6 pce
Pro Palette · Per pallet	51,84 m ² 806,40 kg 48 box	51,84 m ² 806,40 kg 48 box	51,84 m ² 806,40 kg 48 box	51,84 m ² 806,40 kg 48 box
Mindestabgabereinheit · Min. sales unit	P (box)	P (box)	P (box)	P (box)
Berechnungseinheit · Calculation unit	m ²	m ²	m ²	m ²
Preisgruppe · Price group	P79	P79	P79	P79
	■ Oak Park 2793 HR10, Spotlight 2660 CM6L	■ Oak Park 2793 HR10, Spotlight 2660 CM6L	■ Oak Park 2792 HR80	■ Oak Park 2792 HR80

MERIDA *Excellence* by Villeroy & Boch

Concept³

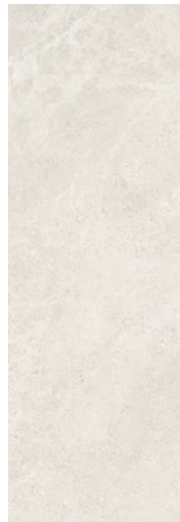

40 x 120 cm



40 x 120 cm



40 x 120 cm



40 x 120 cm

Artikelnummer · Article number	1440
Warengruppe · Product group	AJ10
Werksmaße · Dimensions (mm)	Grundfliese · Basic tile
Farbe · Colour	cream
Oberfläche · Finish	matt Belebte Kalksteinoptik · matt Fresh limestone look CeramicPlus
Erzeugnisgruppe	Steingut
Material	Nonvitreous
Maßeinheit · Unit of measure	m ² 19,04 kg 2,08 pce
Pro Paket · Per box	1,44 m ² 27,42 kg 3 pce
Pro Palette · Per pallet	25,92 m ² 493,56 kg 18 box
Mindestabgabeneinheit · Min. sales unit	P (box)
Berechnungseinheit · Calculation unit	m ²
Preisgruppe · Price group	P120

Artikelnummer · Article number	1440
Warengruppe · Product group	AJ60
Werksmaße · Dimensions (mm)	Grundfliese · Basic tile
Farbe · Colour	light grey
Oberfläche · Finish	matt Belebte Kalksteinoptik · matt Fresh limestone look CeramicPlus
Erzeugnisgruppe	Steingut
Material	Nonvitreous
Maßeinheit · Unit of measure	m ² 19,04 kg 2,08 pce
Pro Paket · Per box	1,44 m ² 27,42 kg 3 pce
Pro Palette · Per pallet	25,92 m ² 493,56 kg 18 box
Mindestabgabeneinheit · Min. sales unit	P (box)
Berechnungseinheit · Calculation unit	m ²
Preisgruppe · Price group	P120

Artikelnummer · Article number	1451
Warengruppe · Product group	AJ10
Werksmaße · Dimensions (mm)	Dekor · Decor
Farbe · Colour	cream
Oberfläche · Finish	matt Belebte Kalksteinoptik reliefiert · matt Fresh limestone look relief CeramicPlus
Erzeugnisgruppe	Steingut
Material	Nonvitreous
Maßeinheit · Unit of measure	m ² 19,04 kg 2,08 pce
Pro Paket · Per box	1,44 m ² 27,42 kg 3 pce
Pro Palette · Per pallet	25,92 m ² 493,56 kg 18 box
Mindestabgabeneinheit · Min. sales unit	P (box)
Berechnungseinheit · Calculation unit	m ²
Preisgruppe · Price group	P140

Artikelnummer · Article number	1451
Warengruppe · Product group	AJ60
Werksmaße · Dimensions (mm)	Dekor · Decor
Farbe · Colour	light grey
Oberfläche · Finish	matt Belebte Kalksteinoptik reliefiert · matt Fresh limestone look relief CeramicPlus
Erzeugnisgruppe	Steingut
Material	Nonvitreous
Maßeinheit · Unit of measure	m ² 19,04 kg 2,08 pce
Pro Paket · Per box	1,44 m ² 27,42 kg 3 pce
Pro Palette · Per pallet	25,92 m ² 493,56 kg 18 box
Mindestabgabeneinheit · Min. sales unit	P (box)
Berechnungseinheit · Calculation unit	m ²
Preisgruppe · Price group	P140

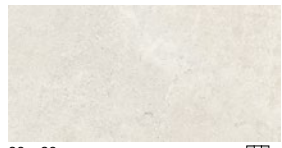

30 x 60 cm



30 x 60 cm



30 x 60 cm



30 x 60 cm

Artikelnummer · Article number	1581
Warengruppe · Product group	AJ10
Werksmaße · Dimensions (mm)	Grundfliese · Basic tile
Farbe · Colour	cream
Oberfläche · Finish	matt Belebte Kalksteinoptik · matt Fresh limestone look CeramicPlus
Erzeugnisgruppe	Steingut
Material	Nonvitreous
Maßeinheit · Unit of measure	m ² 15,56 kg 5,56 pce
Pro Paket · Per box	1,08 m ² 16,80 kg 6 pce
Pro Palette · Per pallet	51,84 m ² 806,40 kg 48 box
Mindestabgabeneinheit · Min. sales unit	P (box)
Berechnungseinheit · Calculation unit	m ²
Preisgruppe · Price group	P87

Artikelnummer · Article number	1581
Warengruppe · Product group	AJ60
Werksmaße · Dimensions (mm)	Grundfliese · Basic tile
Farbe · Colour	light grey
Oberfläche · Finish	matt Belebte Kalksteinoptik · matt Fresh limestone look CeramicPlus
Erzeugnisgruppe	Steingut
Material	Nonvitreous
Maßeinheit · Unit of measure	m ² 15,56 kg 5,56 pce
Pro Paket · Per box	1,08 m ² 16,80 kg 6 pce
Pro Palette · Per pallet	51,84 m ² 806,40 kg 48 box
Mindestabgabeneinheit · Min. sales unit	P (box)
Berechnungseinheit · Calculation unit	m ²
Preisgruppe · Price group	P87

Artikelnummer · Article number	1550
Warengruppe · Product group	AJ10
Werksmaße · Dimensions (mm)	Dekor · Decor
Farbe · Colour	cream
Oberfläche · Finish	matt Belebte Kalksteinoptik reliefiert · matt Fresh limestone look relief CeramicPlus
Erzeugnisgruppe	Steingut
Material	Nonvitreous
Maßeinheit · Unit of measure	m ² 15,56 kg 5,56 pce
Pro Paket · Per box	1,08 m ² 16,80 kg 6 pce
Pro Palette · Per pallet	51,84 m ² 806,40 kg 48 box
Mindestabgabeneinheit · Min. sales unit	P (box)
Berechnungseinheit · Calculation unit	m ²
Preisgruppe · Price group	P117

Artikelnummer · Article number	1550
Warengruppe · Product group	AJ60
Werksmaße · Dimensions (mm)	Dekor · Decor
Farbe · Colour	light grey
Oberfläche · Finish	matt Belebte Kalksteinoptik reliefiert · matt Fresh limestone look relief CeramicPlus
Erzeugnisgruppe	Steingut
Material	Nonvitreous
Maßeinheit · Unit of measure	m ² 15,56 kg 5,56 pce
Pro Paket · Per box	1,08 m ² 16,80 kg 6 pce
Pro Palette · Per pallet	51,84 m ² 806,40 kg 48 box
Mindestabgabeneinheit · Min. sales unit	P (box)
Berechnungseinheit · Calculation unit	m ²
Preisgruppe · Price group	P117

MERIDA *Excellence* by Villeroy & Boch

Concept³



60 x 120 cm

Artikelnummer · Article number	2776
Warengruppe · Product group	AJ20
Werkmaße · Dimensions (mm)	Grundfliese · Basic tile
Farbe · Colour	597 x 1197 x 10 mm
Oberfläche · Finish	ivory
Erzeugnisgruppe	matt Belebte Kalksteinoptik reliefiert · matt Fresh limestone look relief
Material	VilbostonePlus
Maßeinheit · Unit of measure	Feinsteinzeug
Pro Paket · Per box	Porcelain stoneware
Pro Palette · Per pallet	m ² 21,28 kg 1,39 pce
Mindestabgabereinheit · Min. sales unit	1,44 m ² 30,64 kg 2 pce
Berechnungseinheit · Calculation unit	43,2 m ² 919,2 kg 30 box
Preisgruppe · Price group	P (box)
	m ²
	P110



60 x 120 cm

Artikelnummer · Article number	2776
Warengruppe · Product group	AJ20
Werkmaße · Dimensions (mm)	Grundfliese · Basic tile
Farbe · Colour	597 x 1197 x 10 mm
Oberfläche · Finish	sand
Erzeugnisgruppe	matt Belebte Kalksteinoptik reliefiert · matt Fresh limestone look relief
Material	VilbostonePlus
Maßeinheit · Unit of measure	Feinsteinzeug
Pro Paket · Per box	Porcelain stoneware
Pro Palette · Per pallet	m ² 21,28 kg 1,39 pce
Mindestabgabereinheit · Min. sales unit	1,44 m ² 30,64 kg 2 pce
Berechnungseinheit · Calculation unit	43,2 m ² 919,2 kg 30 box
Preisgruppe · Price group	P (box)
	m ²
	P110



60 x 120 cm

Artikelnummer · Article number	2776
Warengruppe · Product group	AJ60
Werkmaße · Dimensions (mm)	Grundfliese · Basic tile
Farbe · Colour	597 x 1197 x 10 mm
Oberfläche · Finish	pebble
Erzeugnisgruppe	matt Belebte Kalksteinoptik reliefiert · matt Fresh limestone look relief
Material	VilbostonePlus
Maßeinheit · Unit of measure	Feinsteinzeug
Pro Paket · Per box	Porcelain stoneware
Pro Palette · Per pallet	m ² 21,28 kg 1,39 pce
Mindestabgabereinheit · Min. sales unit	1,44 m ² 30,64 kg 2 pce
Berechnungseinheit · Calculation unit	43,2 m ² 919,2 kg 30 box
Preisgruppe · Price group	P (box)
	m ²
	P110



60 x 120 cm

Artikelnummer · Article number	2776
Warengruppe · Product group	AJ90
Werkmaße · Dimensions (mm)	Grundfliese · Basic tile
Farbe · Colour	597 x 1197 x 10 mm
Oberfläche · Finish	midnight
Erzeugnisgruppe	matt Belebte Kalksteinoptik reliefiert · matt Fresh limestone look relief
Material	VilbostonePlus
Maßeinheit · Unit of measure	Feinsteinzeug
Pro Paket · Per box	Porcelain stoneware
Pro Palette · Per pallet	m ² 21,28 kg 1,39 pce
Mindestabgabereinheit · Min. sales unit	1,44 m ² 30,64 kg 2 pce
Berechnungseinheit · Calculation unit	43,2 m ² 919,2 kg 30 box
Preisgruppe · Price group	P (box)
	m ²
	P110



60 x 60 cm

Artikelnummer · Article number	2679
Warengruppe · Product group	AJ10
Werkmaße · Dimensions (mm)	Grundfliese · Basic tile
Farbe · Colour	597 x 597 x 9 mm
Oberfläche · Finish	ivory
Erzeugnisgruppe	matt Belebte Kalksteinoptik reliefiert · matt Fresh limestone look relief
Material	VilbostonePlus
Maßeinheit · Unit of measure	Feinsteinzeug
Pro Paket · Per box	Porcelain stoneware
Pro Palette · Per pallet	m ² 20 kg 2,78 pce
Mindestabgabereinheit · Min. sales unit	1,44 m ² 28,80 kg 4 pce
Berechnungseinheit · Calculation unit	43,20 m ² 864 kg 30 box
Preisgruppe · Price group	P (box)
	m ²
	P99



60 x 60 cm

Artikelnummer · Article number	2679
Warengruppe · Product group	AJ20
Werkmaße · Dimensions (mm)	Grundfliese · Basic tile
Farbe · Colour	597 x 597 x 9 mm
Oberfläche · Finish	sand
Erzeugnisgruppe	matt Belebte Kalksteinoptik reliefiert · matt Fresh limestone look relief
Material	VilbostonePlus
Maßeinheit · Unit of measure	Feinsteinzeug
Pro Paket · Per box	Porcelain stoneware
Pro Palette · Per pallet	m ² 20 kg 2,78 pce
Mindestabgabereinheit · Min. sales unit	1,44 m ² 28,80 kg 4 pce
Berechnungseinheit · Calculation unit	43,20 m ² 864 kg 30 box
Preisgruppe · Price group	P (box)
	m ²
	P99



60 x 60 cm

Artikelnummer · Article number	2679
Warengruppe · Product group	AJ60
Werkmaße · Dimensions (mm)	Grundfliese · Basic tile
Farbe · Colour	597 x 597 x 9 mm
Oberfläche · Finish	pebble
Erzeugnisgruppe	matt Belebte Kalksteinoptik reliefiert · matt Fresh limestone look relief
Material	VilbostonePlus
Maßeinheit · Unit of measure	Feinsteinzeug
Pro Paket · Per box	Porcelain stoneware
Pro Palette · Per pallet	m ² 20 kg 2,78 pce
Mindestabgabereinheit · Min. sales unit	1,44 m ² 28,80 kg 4 pce
Berechnungseinheit · Calculation unit	43,20 m ² 864 kg 30 box
Preisgruppe · Price group	P (box)
	m ²
	P99



60 x 60 cm

Artikelnummer · Article number	2679
Warengruppe · Product group	AJ90
Werkmaße · Dimensions (mm)	Grundfliese · Basic tile
Farbe · Colour	597 x 597 x 9 mm
Oberfläche · Finish	midnight
Erzeugnisgruppe	matt Belebte Kalksteinoptik reliefiert · matt Fresh limestone look relief
Material	VilbostonePlus
Maßeinheit · Unit of measure	Feinsteinzeug
Pro Paket · Per box	Porcelain stoneware
Pro Palette · Per pallet	m ² 20 kg 2,78 pce
Mindestabgabereinheit · Min. sales unit	1,44 m ² 28,80 kg 4 pce
Berechnungseinheit · Calculation unit	43,20 m ² 864 kg 30 box
Preisgruppe · Price group	P (box)
	m ²
	P99

MERIDA *Excellence* by Villeroy & Boch

Concept³



5 x 5 cm
□ 0,09 m² | 298 x 298 mm

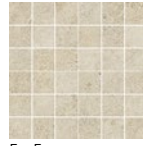

5 x 5 cm
□ 0,09 m² | 298 x 298 mm

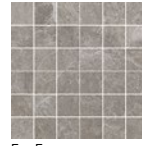

5 x 5 cm
□ 0,09 m² | 298 x 298 mm

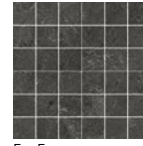

5 x 5 cm
□ 0,09 m² | 298 x 298 mm

Artikelnummer · Article number	2030
Warengruppe · Product group	AJ10
Werksmaße · Dimensions (mm)	Grundfliese · Basic tile 48 x 48 x 9 mm
Farbe · Colour	ivory
Oberfläche · Finish	matt Belebte Kalksteinoptik reliefiert · matt Fresh limestone look relief VilbostonePlus
Erzeugnisgruppe	Feinsteinzeug
Material	Porcelain stoneware
Maßeinheit · Unit of measure	m ² 19,80 kg 11 pce
Pro Paket · Per box	1,09 m ² 21,60 kg 12 pce
Pro Palette · Per pallet	39,27 m ² 777,60 kg 36 box
Mindestabgabereinheit · Min. sales unit	P (box)
Berechnungseinheit · Calculation unit	m ²
Preisgruppe · Price group	P184

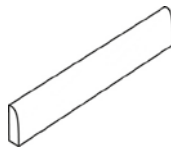

5 x 60 cm

Artikelnummer · Article number	2030
Warengruppe · Product group	AJ20
Werksmaße · Dimensions (mm)	Grundfliese · Basic tile 48 x 48 x 9 mm
Farbe · Colour	sand
Oberfläche · Finish	matt Belebte Kalksteinoptik reliefiert · matt Fresh limestone look relief VilbostonePlus
Erzeugnisgruppe	Feinsteinzeug
Material	Porcelain stoneware
Maßeinheit · Unit of measure	m ² 19,80 kg 11 pce
Pro Paket · Per box	1,09 m ² 21,60 kg 12 pce
Pro Palette · Per pallet	39,27 m ² 777,60 kg 36 box
Mindestabgabereinheit · Min. sales unit	P (box)
Berechnungseinheit · Calculation unit	m ²
Preisgruppe · Price group	P184

Artikelnummer · Article number	2030
Warengruppe · Product group	AJ60
Werksmaße · Dimensions (mm)	Grundfliese · Basic tile 48 x 48 x 9 mm
Farbe · Colour	pebble
Oberfläche · Finish	matt Belebte Kalksteinoptik reliefiert · matt Fresh limestone look relief VilbostonePlus
Erzeugnisgruppe	Feinsteinzeug
Material	Porcelain stoneware
Maßeinheit · Unit of measure	m ² 19,80 kg 11 pce
Pro Paket · Per box	1,09 m ² 21,60 kg 12 pce
Pro Palette · Per pallet	39,27 m ² 777,60 kg 36 box
Mindestabgabereinheit · Min. sales unit	P (box)
Berechnungseinheit · Calculation unit	m ²
Preisgruppe · Price group	P184

Artikelnummer · Article number	2030
Warengruppe · Product group	AJ90
Werksmaße · Dimensions (mm)	Grundfliese · Basic tile 48 x 48 x 9 mm
Farbe · Colour	midnight
Oberfläche · Finish	matt Belebte Kalksteinoptik reliefiert · matt Fresh limestone look relief VilbostonePlus
Erzeugnisgruppe	Feinsteinzeug
Material	Porcelain stoneware
Maßeinheit · Unit of measure	m ² 19,80 kg 11 pce
Pro Paket · Per box	1,09 m ² 21,60 kg 12 pce
Pro Palette · Per pallet	39,27 m ² 777,60 kg 36 box
Mindestabgabereinheit · Min. sales unit	P (box)
Berechnungseinheit · Calculation unit	m ²
Preisgruppe · Price group	P184

Artikelnummer · Article number	2875
Warengruppe · Product group	AJ10, AJ20, AJ60 AJ90
Werksmaße · Dimensions (mm)	Sockel · Skirting 48 x 597 x 9 mm
Farbe · Colour	-
Oberfläche · Finish	matt Belebte Kalksteinoptik reliefiert · matt Fresh limestone look relief VilbostonePlus
Erzeugnisgruppe	Feinsteinzeug
Material	Porcelain stoneware
Maßeinheit · Unit of measure	m 1,05 kg 1,66 pce
Pro Paket · Per box	9,04 m 9,45 kg 15 pce
Pro Palette · Per pallet	433,74 m 453,60 kg 48 box
Mindestabgabereinheit · Min. sales unit	E (pce)
Berechnungseinheit · Calculation unit	Stück · piece
Preisgruppe · Price group	E60

Artikelnummer · Article number	2875
Warengruppe · Product group	AJ10, AJ20, AJ60 AJ90
Werksmaße · Dimensions (mm)	Sockel · Skirting 48 x 597 x 9 mm
Farbe · Colour	-
Oberfläche · Finish	matt Belebte Kalksteinoptik reliefiert · matt Fresh limestone look relief VilbostonePlus
Erzeugnisgruppe	Feinsteinzeug
Material	Porcelain stoneware
Maßeinheit · Unit of measure	m 1,05 kg 1,66 pce
Pro Paket · Per box	9,04 m 9,45 kg 15 pce
Pro Palette · Per pallet	433,74 m 453,60 kg 48 box
Mindestabgabereinheit · Min. sales unit	E (pce)
Berechnungseinheit · Calculation unit	Stück · piece
Preisgruppe · Price group	E60

METALYN Wohnen · Living



Concept³



120 x 260 cm



120 x 260 cm



Artikelnummer · Article number	2962	OPTIMA 6 mm	2962	OPTIMA 6 mm
Warengruppe · Product group	BM09	4 * R9 *	BM79	4 * R9 *
Werksmaße · Dimensions (mm)	Grundfliese · Basic tile		Grundfliese · Basic tile	
Farbe · Colour	1197 x 2600 x 6 mm		1197 x 2600 x 6 mm	
Oberfläche · Finish	silver		bronze	
Erzeugnisgruppe	matt Metall-Beton · matt metal-concrete		matt Metall-Beton · matt metal-concrete	
Material	Feinsteinzeug glasiert		Feinsteinzeug glasiert	
Maßeinheit · Unit of measure	Glazed porcelain stoneware		Glazed porcelain stoneware	
Pro Paket · Per box	m ² 13,96 kg 0,32 pce		m ² 13,96 kg 0,32 pce	
Pro Palette · Per pallet	3,12 m ² 43,57 kg 1 pce		3,12 m ² 43,57 kg 1 pce	
Mindestabgabereinheit · Min. sales unit	68,64 m ² 958,54 kg 22 box		68,64 m ² 958,54 kg 22 box	
Berechnungseinheit · Calculation unit	Stück · piece		Stück · piece	
Preisgruppe · Price group	m ²		m ²	
	P163		P163	

Für Wandanwendungen empfohlen.
 * Nur Längskante rektifiziert
 Recommended for wall coverings.
 *only the long side of the tiles is rectified.

METALYN Wohnen · Living





Concept³



120 x 260 cm 

120 x 260 cm 

Artikelnummer · Article number	2962	OPTIMA 6 mm	2962	OPTIMA 6 mm
Warengruppe · Product group	BM49		BM68	
Werksmaße · Dimensions (mm)	Grundfliese · Basic tile		Grundfliese · Basic tile	
Farbe · Colour	1197 x 2600 x 6 mm		1197 x 2600 x 6 mm	
Oberfläche · Finish	iron		steel	
Erzeugnisgruppe	matt Metall-Beton · matt metal-concrete		matt Metall-Beton · matt metal-concrete	
Material	Feinsteinzeug glasiert		Feinsteinzeug glasiert	
Maßeinheit · Unit of measure	Glazed porcelain stoneware		Glazed porcelain stoneware	
Pro Paket · Per box	m ² 13,96 kg 0,32 pce		m ² 13,96 kg 0,32 pce	
Pro Palette · Per pallet	3,12 m ² 43,57 kg 1 pce		3,12 m ² 43,57 kg 1 pce	
Mindestabgabereinheit · Min. sales unit	68,64 m ² 958,54 kg 22 box		68,64 m ² 958,54 kg 22 box	
Berechnungseinheit · Calculation unit	Stück · piece		Stück · piece	
Preisgruppe · Price group	m ²		m ²	
	P163		P163	

Für Wändenwendungen empfohlen.
 * Nur Längskante rektifiziert
 Recommended for wall coverings.
 *only the long side of the tiles is rectified.

METALYN Wohnen · Living



Concept³



120 x 120 cm



Artikelnummer · Article number	2961
Warengruppe · Product group	Grundfliese · Basic tile
Werksmaße · Dimensions (mm)	1197 x 1197 x 6 mm
Farbe · Colour	silver
Oberfläche · Finish	matt Metall-Beton · matt metal-concrete
Erzeugnisgruppe	Feinsteinzeug
Material	Porcelain stoneware
Maßeinheit · Unit of measure	m ² 13,93 kg 0,69 pce
Pro Paket · Per box	2,88 m ² 40,12 kg 2 pce
Pro Palette · Per pallet	72 m ² 1003 kg 25 box
Mindestabgabereinheit · Min. sales unit	P (box)
Berechnungseinheit · Calculation unit	m ²
Preisgruppe · Price group	P144

Artikelnummer · Article number	2961	OPTIMA 6 mm
Warengruppe · Product group	Grundfliese · Basic tile	
Werksmaße · Dimensions (mm)	1197 x 1197 x 6 mm	
Farbe · Colour	bronze	
Oberfläche · Finish	matt Metall-Beton · matt metal-concrete	VilbostonePlus
Erzeugnisgruppe	Feinsteinzeug	
Material	Porcelain stoneware	
Maßeinheit · Unit of measure	m ² 13,93 kg 0,69 pce	
Pro Paket · Per box	2,88 m ² 40,12 kg 2 pce	
Pro Palette · Per pallet	72 m ² 1003 kg 25 box	
Mindestabgabereinheit · Min. sales unit	P (box)	
Berechnungseinheit · Calculation unit	m ²	
Preisgruppe · Price group	P144	



120 x 120 cm

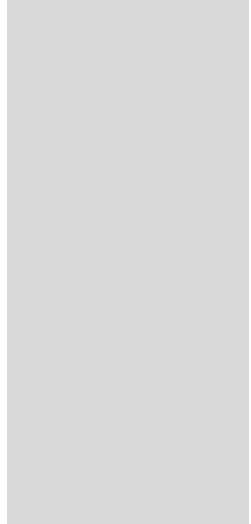

120 x 120 cm



Artikelnummer · Article number	2961
Warengruppe · Product group	Grundfliese · Basic tile
Werksmaße · Dimensions (mm)	1197 x 1197 x 6 mm
Farbe · Colour	iron
Oberfläche · Finish	matt Metall-Beton · matt metal-concrete
Erzeugnisgruppe	Feinsteinzeug
Material	Porcelain stoneware
Maßeinheit · Unit of measure	m ² 13,93 kg 0,69 pce
Pro Paket · Per box	2,88 m ² 40,12 kg 2 pce
Pro Palette · Per pallet	72 m ² 1003 kg 25 box
Mindestabgabereinheit · Min. sales unit	P (box)
Berechnungseinheit · Calculation unit	m ²
Preisgruppe · Price group	P144

Artikelnummer · Article number	2961	OPTIMA 6 mm
Warengruppe · Product group	Grundfliese · Basic tile	
Werksmaße · Dimensions (mm)	1197 x 1197 x 6 mm	
Farbe · Colour	steel	
Oberfläche · Finish	matt Metall-Beton · matt metal-concrete	VilbostonePlus
Erzeugnisgruppe	Feinsteinzeug	
Material	Porcelain stoneware	
Maßeinheit · Unit of measure	m ² 13,93 kg 0,69 pce	
Pro Paket · Per box	2,88 m ² 40,12 kg 2 pce	
Pro Palette · Per pallet	72 m ² 1003 kg 25 box	
Mindestabgabereinheit · Min. sales unit	P (box)	
Berechnungseinheit · Calculation unit	m ²	
Preisgruppe · Price group	P144	



120 x 120 cm



Artikelnummer · Article number	2961
Warengruppe · Product group	Grundfliese · Basic tile
Werksmaße · Dimensions (mm)	1197 x 1197 x 6 mm
Farbe · Colour	steel
Oberfläche · Finish	matt Metall-Beton · matt metal-concrete
Erzeugnisgruppe	Feinsteinzeug
Material	Porcelain stoneware
Maßeinheit · Unit of measure	m ² 13,93 kg 0,69 pce
Pro Paket · Per box	2,88 m ² 40,12 kg 2 pce
Pro Palette · Per pallet	72 m ² 1003 kg 25 box
Mindestabgabereinheit · Min. sales unit	P (box)
Berechnungseinheit · Calculation unit	m ²
Preisgruppe · Price group	P144

Artikelnummer · Article number	2961	OPTIMA 6 mm
Warengruppe · Product group	Grundfliese · Basic tile	
Werksmaße · Dimensions (mm)	1197 x 1197 x 6 mm	
Farbe · Colour	steel	
Oberfläche · Finish	matt Metall-Beton · matt metal-concrete	VilbostonePlus
Erzeugnisgruppe	Feinsteinzeug	
Material	Porcelain stoneware	
Maßeinheit · Unit of measure	m ² 13,93 kg 0,69 pce	
Pro Paket · Per box	2,88 m ² 40,12 kg 2 pce	
Pro Palette · Per pallet	72 m ² 1003 kg 25 box	
Mindestabgabereinheit · Min. sales unit	P (box)	
Berechnungseinheit · Calculation unit	m ²	
Preisgruppe · Price group	P144	

Artikelnummer · Article number	2961	OPTIMA 6 mm
Warengruppe · Product group	Grundfliese · Basic tile	
Werksmaße · Dimensions (mm)	1197 x 1197 x 6 mm	
Farbe · Colour	steel	
Oberfläche · Finish	matt Metall-Beton · matt metal-concrete	VilbostonePlus
Erzeugnisgruppe	Feinsteinzeug	
Material	Porcelain stoneware	
Maßeinheit · Unit of measure	m ² 13,93 kg 0,69 pce	
Pro Paket · Per box	2,88 m ² 40,12 kg 2 pce	
Pro Palette · Per pallet	72 m ² 1003 kg 25 box	
Mindestabgabereinheit · Min. sales unit	P (box)	
Berechnungseinheit · Calculation unit	m ²	
Preisgruppe · Price group	P144	



reddot design award
winner 2018

Concept³

METALYN Wohnen · Living



60 x 120 cm



Artikelnummer · Article number	2960	OPTIMA 6 mm
Warengruppe · Product group	BM06	
Werksmaße · Dimensions (mm)	Grundfliese · Basic tile	
Farbe · Colour	597 x 1197 x 6 mm	
Oberfläche · Finish	silver	
Erzeugnisgruppe	matt Metall-Beton · matt metal-concrete	VilbostonePlus
Material	Feinsteinzeug	
Maßeinheit · Unit of measure	Porcelain stoneware	
Pro Paket · Per box	m ² 13,89 kg 1,39 pce	
Pro Palette · Per pallet	1,44 m ² 20 kg 2 pce	
Mindestabgabereinheit · Min. sales unit	72 m ² 1000 kg 50 box	
Berechnungseinheit · Calculation unit	P (box)	
Preisgruppe · Price group	m ²	P120



60 x 120 cm



Artikelnummer · Article number	2960	OPTIMA 6 mm
Warengruppe · Product group	BM70	
Werksmaße · Dimensions (mm)	Grundfliese · Basic tile	
Farbe · Colour	597 x 1197 x 6 mm	
Oberfläche · Finish	bronze	
Erzeugnisgruppe	matt Metall-Beton · matt metal-concrete	VilbostonePlus
Material	Feinsteinzeug	
Maßeinheit · Unit of measure	Porcelain stoneware	
Pro Paket · Per box	m ² 13,89 kg 1,39 pce	
Pro Palette · Per pallet	1,44 m ² 20 kg 2 pce	
Mindestabgabereinheit · Min. sales unit	72 m ² 1000 kg 50 box	
Berechnungseinheit · Calculation unit	P (box)	
Preisgruppe · Price group	m ²	P120



60 x 120 cm



Artikelnummer · Article number	2960	OPTIMA 6 mm
Warengruppe · Product group	BM40	
Werksmaße · Dimensions (mm)	Grundfliese · Basic tile	
Farbe · Colour	597 x 1197 x 6 mm	
Oberfläche · Finish	iron	
Erzeugnisgruppe	matt Metall-Beton · matt metal-concrete	VilbostonePlus
Material	Feinsteinzeug	
Maßeinheit · Unit of measure	Porcelain stoneware	
Pro Paket · Per box	m ² 13,89 kg 1,39 pce	
Pro Palette · Per pallet	1,44 m ² 20 kg 2 pce	
Mindestabgabereinheit · Min. sales unit	72 m ² 1000 kg 50 box	
Berechnungseinheit · Calculation unit	P (box)	
Preisgruppe · Price group	m ²	P120



60 x 120 cm



Artikelnummer · Article number	2960	OPTIMA 6 mm
Warengruppe · Product group	BM60	
Werksmaße · Dimensions (mm)	Grundfliese · Basic tile	
Farbe · Colour	597 x 1197 x 6 mm	
Oberfläche · Finish	steel	
Erzeugnisgruppe	matt Metall-Beton · matt metal-concrete	VilbostonePlus
Material	Feinsteinzeug	
Maßeinheit · Unit of measure	Porcelain stoneware	
Pro Paket · Per box	m ² 13,89 kg 1,39 pce	
Pro Palette · Per pallet	1,44 m ² 20 kg 2 pce	
Mindestabgabereinheit · Min. sales unit	72 m ² 1000 kg 50 box	
Berechnungseinheit · Calculation unit	P (box)	
Preisgruppe · Price group	m ²	P120

METALYN Wohnen · Living













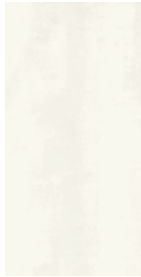















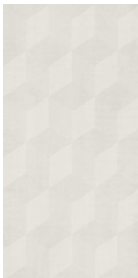



Concept³

	40 x 120 cm	40 x 120 cm	40 x 120 cm	40 x 120 cm
Artikelnummer · Article number	1440	1440	1440	1440
	BM00	BM20	BM60	BM90
Warengruppe · Product group	Grundfliese · Basic tile	Grundfliese · Basic tile	Grundfliese · Basic tile	Grundfliese · Basic tile
Werkmaße · Dimensions (mm)	397 x 1197 x 11 mm	397 x 1197 x 11 mm	397 x 1197 x 11 mm	397 x 1197 x 11 mm
Farbe · Colour	titan white	pearl beige	silver grey	platinum grey
Oberfläche · Finish	matt CeramicPlus	matt CeramicPlus	matt CeramicPlus	matt CeramicPlus
Erzeugnisgruppe	Steingut	Steingut	Steingut	Steingut
Material	Nonvitreous	Nonvitreous	Nonvitreous	Nonvitreous
Maßeinheit · Unit of measure	m ² 19,04 kg 2,08 pce	m ² 19,04 kg 2,08 pce	m ² 19,04 kg 2,08 pce	m ² 19,04 kg 2,08 pce
Pro Paket · Per box	1,44 m ² 27,42 kg 3 pce	1,44 m ² 27,42 kg 3 pce	1,44 m ² 27,42 kg 3 pce	1,44 m ² 27,42 kg 3 pce
Pro Palette · Per pallet	25,92 m ² 493,56 kg 18 box	25,92 m ² 493,56 kg 18 box	25,92 m ² 493,56 kg 18 box	25,92 m ² 493,56 kg 18 box
Mindestabgabereinheit · Min. sales unit	P (box)	P (box)	P (box)	P (box)
Berechnungseinheit · Calculation unit	m ²	m ²	m ²	m ²
Preisgruppe · Price group	P120	P120	P120	P120
	40 x 120 cm	40 x 120 cm	40 x 120 cm	40 x 120 cm
Artikelnummer · Article number	1440	1440	1440	1440
	BM02	BM22	BM62	BM92
Warengruppe · Product group	Dekor · Decor	Dekor · Decor	Dekor · Decor	Dekor · Decor
Werkmaße · Dimensions (mm)	397 x 1197 x 11 mm	397 x 1197 x 11 mm	397 x 1197 x 11 mm	397 x 1197 x 11 mm
Farbe · Colour	titan white	pearl beige	silver grey	platinum grey
Oberfläche · Finish	matt CeramicPlus	matt CeramicPlus	matt CeramicPlus	matt CeramicPlus
Erzeugnisgruppe	Steingut	Steingut	Steingut	Steingut
Material	Nonvitreous	Nonvitreous	Nonvitreous	Nonvitreous
Maßeinheit · Unit of measure	m ² 19,04 kg 2,08 pce	m ² 19,04 kg 2,08 pce	m ² 19,04 kg 2,08 pce	m ² 19,04 kg 2,08 pce
Pro Paket · Per box	1,44 m ² 27,42 kg 3 pce	1,44 m ² 27,42 kg 3 pce	1,44 m ² 27,42 kg 3 pce	1,44 m ² 27,42 kg 3 pce
Pro Palette · Per pallet	25,92 m ² 493,56 kg 18 box	25,92 m ² 493,56 kg 18 box	25,92 m ² 493,56 kg 18 box	25,92 m ² 493,56 kg 18 box
Mindestabgabereinheit · Min. sales unit	P (box)	P (box)	P (box)	P (box)
Berechnungseinheit · Calculation unit	m ²	m ²	m ²	m ²
Preisgruppe · Price group	P132	P132	P132	P132

METALYN Wohnen · Living



Concept³

				
	30 x 60 cm  1	30 x 60 cm  2	30 x 60 cm  2	30 x 60 cm  2
Artikelnummer · Article number	1581	1581	1581	1581
	BM00  	BM20  	BM60  	BM90  
Warengruppe · Product group	Grundfliese · Basic tile	Grundfliese · Basic tile	Grundfliese · Basic tile	Grundfliese · Basic tile
Werksmaße · Dimensions (mm)	297 x 597 x 9 mm	297 x 597 x 9 mm	297 x 597 x 9 mm	297 x 597 x 9 mm
Farbe · Colour	titan white	pearl beige	silver grey	platinum grey
Oberfläche · Finish	matt CeramicPlus	matt CeramicPlus	matt CeramicPlus	matt CeramicPlus
Erzeugnisgruppe	Steingut	Steingut	Steingut	Steingut
Material	Nonvitreous	Nonvitreous	Nonvitreous	Nonvitreous
Maßeinheit · Unit of measure	m ² 15,56 kg 5,56 pce	m ² 15,56 kg 5,56 pce	m ² 15,56 kg 5,56 pce	m ² 15,56 kg 5,56 pce
Pro Paket · Per box	1,08 m ² 16,80 kg 6 pce	1,08 m ² 16,80 kg 6 pce	1,08 m ² 16,80 kg 6 pce	1,08 m ² 16,80 kg 6 pce
Pro Palette · Per pallet	51,84 m ² 806,40 kg 48 box	51,84 m ² 806,40 kg 48 box	51,84 m ² 806,40 kg 48 box	51,84 m ² 806,40 kg 48 box
Mindestabgabereinheit · Min. sales unit	P (box)	P (box)	P (box)	P (box)
Berechnungseinheit · Calculation unit	m ²	m ²	m ²	m ²
Preisgruppe · Price group	P87	P87	P87	P87
				
	30 x 60 cm  1	30 x 60 cm  2	30 x 60 cm  2	30 x 60 cm  2
Artikelnummer · Article number	1581	1581	1581	1581
	BM02  	BM22  	BM62  	BM92  
Warengruppe · Product group	Dekor · Decor	Dekor · Decor	Dekor · Decor	Dekor · Decor
Werksmaße · Dimensions (mm)	297 x 597 x 9 mm	297 x 597 x 9 mm	297 x 597 x 9 mm	297 x 597 x 9 mm
Farbe · Colour	titan white	pearl beige	silver grey	platinum grey
Oberfläche · Finish	matt CeramicPlus	matt CeramicPlus	matt CeramicPlus	matt CeramicPlus
Erzeugnisgruppe	Steingut	Steingut	Steingut	Steingut
Material	Nonvitreous	Nonvitreous	Nonvitreous	Nonvitreous
Maßeinheit · Unit of measure	m ² 15,56 kg 5,56 pce	m ² 15,56 kg 5,56 pce	m ² 15,56 kg 5,56 pce	m ² 15,56 kg 5,56 pce
Pro Paket · Per box	1,08 m ² 16,80 kg 6 pce	1,08 m ² 16,80 kg 6 pce	1,08 m ² 16,80 kg 6 pce	1,08 m ² 16,80 kg 6 pce
Pro Palette · Per pallet	51,84 m ² 806,40 kg 48 box	51,84 m ² 806,40 kg 48 box	51,84 m ² 806,40 kg 48 box	51,84 m ² 806,40 kg 48 box
Mindestabgabereinheit · Min. sales unit	P (box)	P (box)	P (box)	P (box)
Berechnungseinheit · Calculation unit	m ²	m ²	m ²	m ²
Preisgruppe · Price group	P114	P114	P114	P114

METALYN Wohnen · Living



Concept³

60 x 120 cm	60 x 120 cm	60 x 120 cm	60 x 120 cm
2730	2730	2730	2730
BM06	BM10	BM70	BM40
Grundfliese · Basic tile	Grundfliese · Basic tile	Grundfliese · Basic tile	Grundfliese · Basic tile
Werkmaße · Dimensions (mm) 597 x 1197 x 10 mm	Werkmaße · Dimensions (mm) 597 x 1197 x 10 mm	Werkmaße · Dimensions (mm) 597 x 1197 x 10 mm	Werkmaße · Dimensions (mm) 597 x 1197 x 10 mm
Farbe · Colour silver	Farbe · Colour pearl	Farbe · Colour bronze	Farbe · Colour iron
Oberfläche · Finish matt Metall-Beton · matt metal-concrete VilbostonePlus	Oberfläche · Finish matt Metall-Beton · matt metal-concrete VilbostonePlus	Oberfläche · Finish matt Metall-Beton · matt metal-concrete VilbostonePlus	Oberfläche · Finish matt Metall-Beton · matt metal-concrete VilbostonePlus
Erzeugnisgruppe Feinsteinzeug	Erzeugnisgruppe Feinsteinzeug	Erzeugnisgruppe Feinsteinzeug	Erzeugnisgruppe Feinsteinzeug
Material Porcelain stoneware	Material Porcelain stoneware	Material Porcelain stoneware	Material Porcelain stoneware
Maßeinheit · Unit of measure m ² 21,28 kg 1,39 pce	Maßeinheit · Unit of measure m ² 21,28 kg 1,39 pce	Maßeinheit · Unit of measure m ² 21,28 kg 1,39 pce	Maßeinheit · Unit of measure m ² 21,28 kg 1,39 pce
Pro Paket · Per box 1,44 m ² 30,64 kg 2 pce	Pro Paket · Per box 1,44 m ² 30,64 kg 2 pce	Pro Paket · Per box 1,44 m ² 30,64 kg 2 pce	Pro Paket · Per box 1,44 m ² 30,64 kg 2 pce
Pro Palette · Per pallet 43,2 m ² 919,2 kg 30 box	Pro Palette · Per pallet 43,2 m ² 919,2 kg 30 box	Pro Palette · Per pallet 43,2 m ² 919,2 kg 30 box	Pro Palette · Per pallet 43,2 m ² 919,2 kg 30 box
Mindestabgabereinheit · Min. sales unit P (box)	Mindestabgabereinheit · Min. sales unit P (box)	Mindestabgabereinheit · Min. sales unit P (box)	Mindestabgabereinheit · Min. sales unit P (box)
Berechnungseinheit · Calculation unit m ²	Berechnungseinheit · Calculation unit m ²	Berechnungseinheit · Calculation unit m ²	Berechnungseinheit · Calculation unit m ²
Preisgruppe · Price group P110	Preisgruppe · Price group P110	Preisgruppe · Price group P110	Preisgruppe · Price group P110
60 x 120 cm	60 x 120 cm	60 x 120 cm	30 x 120 cm
2730	2730	2730	2356
BM60	BM61	BM65	BM65
Grundfliese · Basic tile	Grundfliese · Basic tile	Dekor · Decor	Dekor · Decor
Werkmaße · Dimensions (mm) 597 x 1197 x 10 mm	Werkmaße · Dimensions (mm) 597 x 1197 x 10 mm	Werkmaße · Dimensions (mm) 597 x 1197 x 10 mm	Werkmaße · Dimensions (mm) 297 x 1197 x 10 mm
Farbe · Colour steel	Farbe · Colour oxide	Farbe · Colour multicolor	Farbe · Colour multicolor
Oberfläche · Finish matt Metall-Beton · matt metal-concrete VilbostonePlus	Oberfläche · Finish matt Metall-Beton · matt metal-concrete VilbostonePlus	Oberfläche · Finish matt Metall-Beton · matt metal-concrete	Oberfläche · Finish matt Metall-Beton · matt metal-concrete
Erzeugnisgruppe Feinsteinzeug	Erzeugnisgruppe Feinsteinzeug	Erzeugnisgruppe Feinsteinzeug glasiert	Erzeugnisgruppe Feinsteinzeug glasiert
Material Porcelain stoneware	Material Porcelain stoneware	Material Glazed porcelain stoneware	Material Glazed porcelain stoneware
Maßeinheit · Unit of measure m ² 21,28 kg 1,39 pce	Maßeinheit · Unit of measure m ² 21,28 kg 1,39 pce	Maßeinheit · Unit of measure m ² 21,28 kg 1,39 pce	Maßeinheit · Unit of measure m ² 22,22 kg 2,78 pce
Pro Paket · Per box 1,44 m ² 30,64 kg 2 pce	Pro Paket · Per box 1,44 m ² 30,64 kg 2 pce	Pro Paket · Per box 1,44 m ² 30,64 kg 2 pce	Pro Paket · Per box 1,44 m ² 32 kg 4 pce
Pro Palette · Per pallet 43,2 m ² 919,2 kg 30 box	Pro Palette · Per pallet 43,2 m ² 919,2 kg 30 box	Pro Palette · Per pallet 43,2 m ² 919,2 kg 30 box	Pro Palette · Per pallet 43,20 m ² 960 kg 30 box
Mindestabgabereinheit · Min. sales unit P (box)	Mindestabgabereinheit · Min. sales unit P (box)	Mindestabgabereinheit · Min. sales unit P (box)	Mindestabgabereinheit · Min. sales unit P (box)
Berechnungseinheit · Calculation unit m ²	Berechnungseinheit · Calculation unit m ²	Berechnungseinheit · Calculation unit m ²	Berechnungseinheit · Calculation unit m ²
Preisgruppe · Price group P110	Preisgruppe · Price group P110	Preisgruppe · Price group P144	Preisgruppe · Price group P143

METALYN Wohnen · Living



80 x 80 cm

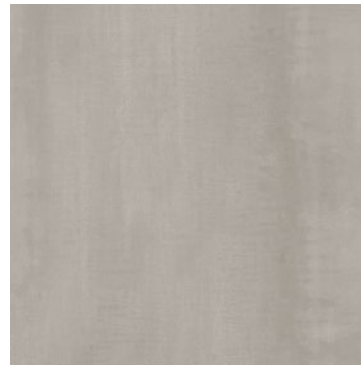

80 x 80 cm



Artikelnummer · Article number	2810
Warengruppe · Product group	Grundfliese · Basic tile
Werksmaße · Dimensions (mm)	797 x 797 x 9 mm
Farbe · Colour	silver
Oberfläche · Finish	matt Metall-Beton · matt metal-concrete
Erzeugnisgruppe	Feinsteinzeug
Material	Porcelain stoneware
Maßeinheit · Unit of measure	m ² 19,06 kg 1,56 pce
Pro Paket · Per box	1,28 m ² 24,40 kg 2 pce
Pro Palette · Per pallet	51,20 m ² 976 kg 40 box
Mindestabgabereinheit · Min. sales unit	P (box)
Berechnungseinheit · Calculation unit	m ²
Preisgruppe · Price group	P110

Artikelnummer · Article number	2810
Warengruppe · Product group	Grundfliese · Basic tile
Werksmaße · Dimensions (mm)	797 x 797 x 9 mm
Farbe · Colour	pearl
Oberfläche · Finish	matt Metall-Beton · matt metal-concrete
Erzeugnisgruppe	Feinsteinzeug
Material	Porcelain stoneware
Maßeinheit · Unit of measure	m ² 19,06 kg 1,56 pce
Pro Paket · Per box	1,28 m ² 24,40 kg 2 pce
Pro Palette · Per pallet	51,20 m ² 976 kg 40 box
Mindestabgabereinheit · Min. sales unit	P (box)
Berechnungseinheit · Calculation unit	m ²
Preisgruppe · Price group	P110

Artikelnummer · Article number	2810
Warengruppe · Product group	Grundfliese · Basic tile
Werksmaße · Dimensions (mm)	797 x 797 x 9 mm
Farbe · Colour	bronze
Oberfläche · Finish	matt Metall-Beton · matt metal-concrete
Erzeugnisgruppe	Feinsteinzeug
Material	Porcelain stoneware
Maßeinheit · Unit of measure	m ² 19,06 kg 1,56 pce
Pro Paket · Per box	1,28 m ² 24,40 kg 2 pce
Pro Palette · Per pallet	51,20 m ² 976 kg 40 box
Mindestabgabereinheit · Min. sales unit	P (box)
Berechnungseinheit · Calculation unit	m ²
Preisgruppe · Price group	P110



80 x 80 cm



80 x 80 cm



Artikelnummer · Article number	2810
Warengruppe · Product group	Grundfliese · Basic tile
Werksmaße · Dimensions (mm)	797 x 797 x 9 mm
Farbe · Colour	bronze
Oberfläche · Finish	matt Metall-Beton · matt metal-concrete
Erzeugnisgruppe	Feinsteinzeug
Material	Porcelain stoneware
Maßeinheit · Unit of measure	m ² 19,06 kg 1,56 pce
Pro Paket · Per box	1,28 m ² 24,40 kg 2 pce
Pro Palette · Per pallet	51,20 m ² 976 kg 40 box
Mindestabgabereinheit · Min. sales unit	P (box)
Berechnungseinheit · Calculation unit	m ²
Preisgruppe · Price group	P110

Artikelnummer · Article number	2810
Warengruppe · Product group	Grundfliese · Basic tile
Werksmaße · Dimensions (mm)	797 x 797 x 9 mm
Farbe · Colour	iron
Oberfläche · Finish	matt Metall-Beton · matt metal-concrete
Erzeugnisgruppe	Feinsteinzeug
Material	Porcelain stoneware
Maßeinheit · Unit of measure	m ² 19,06 kg 1,56 pce
Pro Paket · Per box	1,28 m ² 24,40 kg 2 pce
Pro Palette · Per pallet	51,20 m ² 976 kg 40 box
Mindestabgabereinheit · Min. sales unit	P (box)
Berechnungseinheit · Calculation unit	m ²
Preisgruppe · Price group	P110

Artikelnummer · Article number	2810
Warengruppe · Product group	Grundfliese · Basic tile
Werksmaße · Dimensions (mm)	797 x 797 x 9 mm
Farbe · Colour	iron
Oberfläche · Finish	matt Metall-Beton · matt metal-concrete
Erzeugnisgruppe	Feinsteinzeug
Material	Porcelain stoneware
Maßeinheit · Unit of measure	m ² 19,06 kg 1,56 pce
Pro Paket · Per box	1,28 m ² 24,40 kg 2 pce
Pro Palette · Per pallet	51,20 m ² 976 kg 40 box
Mindestabgabereinheit · Min. sales unit	P (box)
Berechnungseinheit · Calculation unit	m ²
Preisgruppe · Price group	P110

METALYN Wohnen · Living



Concept³



80 x 80 cm



80 x 80 cm



Artikelnummer · Article number
Warengruppe · Product group
Werkmaße · Dimensions (mm)
Farbe · Colour
Oberfläche · Finish
Erzeugnisgruppe
Material
Maßeinheit · Unit of measure
Pro Paket · Per box
Pro Palette · Per pallet
Mindestabgabereinheit · Min. sales unit
Berechnungseinheit · Calculation unit
Preisgruppe · Price group

2810
BM60
Grundfliese · Basic tile
797 x 797 x 9 mm
steel
matt Metall-Beton · matt metal-concrete VilbostonePlus
Feinsteinzeug
Porcelain stoneware
m ² 19,06 kg 1,56 pce
1,28 m ² 24,40 kg 2 pce
51,20 m ² 976 kg 40 box
P (box)
m ²
P110

2810
BM61
Grundfliese · Basic tile
797 x 797 x 9 mm
oxide
matt Metall-Beton · matt metal-concrete VilbostonePlus
Feinsteinzeug
Porcelain stoneware
m ² 19,06 kg 1,56 pce
1,28 m ² 24,40 kg 2 pce
51,20 m ² 976 kg 40 box
P (box)
m ²
P110



60 x 60 cm



60 x 60 cm



60 x 60 cm



60 x 60 cm



Artikelnummer · Article number
Warengruppe · Product group
Werkmaße · Dimensions (mm)
Farbe · Colour
Oberfläche · Finish
Erzeugnisgruppe
Material
Maßeinheit · Unit of measure
Pro Paket · Per box
Pro Palette · Per pallet
Mindestabgabereinheit · Min. sales unit
Berechnungseinheit · Calculation unit
Preisgruppe · Price group

2660
BM06
Grundfliese · Basic tile
597 x 597 x 10 mm
silver
matt Metall-Beton · matt metal-concrete VilbostonePlus
Feinsteinzeug
Porcelain stoneware
m ² 22,22 kg 2,78 pce
1,44 m ² 32 kg 4 pce
43,20 m ² 960 kg 30 box
P (box)
m ²
P99

2660
BM10
Grundfliese · Basic tile
597 x 597 x 10 mm
pearl
matt Metall-Beton · matt metal-concrete VilbostonePlus
Feinsteinzeug
Porcelain stoneware
m ² 22,22 kg 2,78 pce
1,44 m ² 32 kg 4 pce
43,20 m ² 960 kg 30 box
P (box)
m ²
P99

2660
BM70
Grundfliese · Basic tile
597 x 597 x 10 mm
bronze
matt Metall-Beton · matt metal-concrete VilbostonePlus
Feinsteinzeug
Porcelain stoneware
m ² 22,22 kg 2,78 pce
1,44 m ² 32 kg 4 pce
43,20 m ² 960 kg 30 box
P (box)
m ²
P99

2660
BM40
Grundfliese · Basic tile
597 x 597 x 10 mm
iron
matt Metall-Beton · matt metal-concrete VilbostonePlus
Feinsteinzeug
Porcelain stoneware
m ² 22,22 kg 2,78 pce
1,44 m ² 32 kg 4 pce
43,20 m ² 960 kg 30 box
P (box)
m ²
P99

METALYN Wohnen · Living



Concept³

	60 x 60 cm	60 x 60 cm	30 x 60 cm	30 x 60 cm
Artikelnummer · Article number	2660	2660	2394	2394
Warengruppe · Product group	BM60	BM61	BM06	BM10
Werkmaße · Dimensions (mm)	Grundfliese · Basic tile 597 x 597 x 10 mm	Grundfliese · Basic tile 597 x 597 x 10 mm	Grundfliese · Basic tile 297 x 597 x 10 mm	Grundfliese · Basic tile 297 x 597 x 10 mm
Farbe · Colour	steel	oxide	silver	pearl
Oberfläche · Finish	matt Metall-Beton · matt metal-concrete VilbostonePlus	matt Metall-Beton · matt metal-concrete VilbostonePlus	matt Metall-Beton · matt metal-concrete VilbostonePlus	matt Metall-Beton · matt metal-concrete VilbostonePlus
Erzeugnisgruppe	Feinsteinzeug	Feinsteinzeug	Feinsteinzeug	Feinsteinzeug
Material	Porcelain stoneware	Porcelain stoneware	Porcelain stoneware	Porcelain stoneware
Maßeinheit · Unit of measure	m ² 22,22 kg 2,78 pce	m ² 22,22 kg 2,78 pce	m ² 22,22 kg 5,56 pce	m ² 22,22 kg 5,56 pce
Pro Paket · Per box	1,44 m ² 32 kg 4 pce	1,44 m ² 32 kg 4 pce	1,08 m ² 24 kg 6 pce	1,08 m ² 24 kg 6 pce
Pro Palette · Per pallet	43,20 m ² 960 kg 30 box	43,20 m ² 960 kg 30 box	43,20 m ² 960 kg 40 box	43,20 m ² 960 kg 40 box
Mindestabgabereinheit · Min. sales unit	P (box)	P (box)	P (box)	P (box)
Berechnungseinheit · Calculation unit	m ²	m ²	m ²	m ²
Preisgruppe · Price group	P99	P99	P87	P87
Artikelnummer · Article number	2394	2394	2394	2394
Warengruppe · Product group	BM70	BM40	BM06	BM61
Werkmaße · Dimensions (mm)	Grundfliese · Basic tile 297 x 597 x 10 mm	Grundfliese · Basic tile 297 x 597 x 10 mm	Grundfliese · Basic tile 297 x 597 x 10 mm	Grundfliese · Basic tile 297 x 597 x 10 mm
Farbe · Colour	bronze	iron	steel	oxide
Oberfläche · Finish	matt Metall-Beton · matt metal-concrete VilbostonePlus	matt Metall-Beton · matt metal-concrete VilbostonePlus	matt Metall-Beton · matt metal-concrete VilbostonePlus	matt Metall-Beton · matt metal-concrete VilbostonePlus
Erzeugnisgruppe	Feinsteinzeug	Feinsteinzeug	Feinsteinzeug	Feinsteinzeug
Material	Porcelain stoneware	Porcelain stoneware	Porcelain stoneware	Porcelain stoneware
Maßeinheit · Unit of measure	m ² 22,22 kg 5,56 pce	m ² 22,22 kg 5,56 pce	m ² 22,22 kg 5,56 pce	m ² 22,22 kg 5,56 pce
Pro Paket · Per box	1,08 m ² 24 kg 6 pce	1,08 m ² 24 kg 6 pce	1,08 m ² 24 kg 6 pce	1,08 m ² 24 kg 6 pce
Pro Palette · Per pallet	43,20 m ² 960 kg 40 box	43,20 m ² 960 kg 40 box	43,20 m ² 960 kg 40 box	43,20 m ² 960 kg 40 box
Mindestabgabereinheit · Min. sales unit	P (box)	P (box)	P (box)	P (box)
Berechnungseinheit · Calculation unit	m ²	m ²	m ²	m ²
Preisgruppe · Price group	P87	P87	P87	P87
Artikelnummer · Article number	2024	2024	2024	2024
Warengruppe · Product group	BM06	BM10	BM70	BM40
Werkmaße · Dimensions (mm)	Dekor · Decor 16,68 x 597 x 10 mm	Dekor · Decor 16,68 x 597 x 10 mm	Dekor · Decor 16,68 x 597 x 10 mm	Dekor · Decor 16,68 x 597 x 10 mm
Farbe · Colour	silver	pearl	bronze	iron
Oberfläche · Finish	matt Metall-Beton · matt metal-concrete VilbostonePlus	matt Metall-Beton · matt metal-concrete VilbostonePlus	matt Metall-Beton · matt metal-concrete VilbostonePlus	matt Metall-Beton · matt metal-concrete VilbostonePlus
Erzeugnisgruppe	Feinsteinzeug	Feinsteinzeug	Feinsteinzeug	Feinsteinzeug
Material	Porcelain stoneware	Porcelain stoneware	Porcelain stoneware	Porcelain stoneware
Maßeinheit · Unit of measure	m ² 22,22 kg 5,56 pce	m ² 22,22 kg 5,56 pce	m ² 22,22 kg 5,56 pce	m ² 22,22 kg 5,56 pce
Pro Paket · Per box	0,72 m ² 16 kg 4 pce	0,72 m ² 16 kg 4 pce	0,72 m ² 16 kg 4 pce	0,72 m ² 16 kg 4 pce
Pro Palette · Per pallet	25,92 m ² 576 kg 36 box	25,92 m ² 576 kg 36 box	25,92 m ² 576 kg 36 box	25,92 m ² 576 kg 36 box
Mindestabgabereinheit · Min. sales unit	P (box)	P (box)	P (box)	P (box)
Berechnungseinheit · Calculation unit	m ²	m ²	m ²	m ²
Preisgruppe · Price group	P193	P193	P193	P193

METALYN Wohnen · Living



Concept³

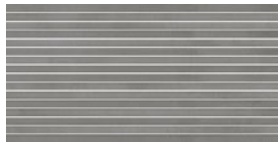

1,7 x 60 cm
□ 0,18 m² | 297 x 597 mm

2024
BM60
Dekor · Decor
Werkmaße · Dimensions (mm)
16,68 x 597 x 10 mm
Farbe · Colour
steel
Oberfläche · Finish
matt Metall-Beton · matt metal-concrete VilbostonePlus
Erzeugnisgruppe
Feinsteinzeug
Material
Porcelain stoneware
Maßeinheit · Unit of measure
m ² 22,22 kg 5,56 pce
Pro Paket · Per box
0,72 m ² 16 kg 4 pce
Pro Palette · Per pallet
25,92 m ² 576 kg 36 box
Mindestabgabereinheit · Min. sales unit
P (box)
Berechnungseinheit · Calculation unit
m ²
P193

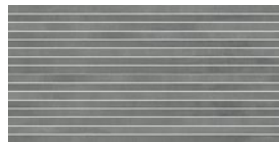

1,7 x 60 cm
□ 0,18 m² | 297 x 597 mm

2024
BM61
Dekor · Decor
Werkmaße · Dimensions (mm)
16,68 x 597 x 10 mm
Farbe · Colour
oxide
Oberfläche · Finish
matt Metall-Beton · matt metal-concrete VilbostonePlus
Erzeugnisgruppe
Feinsteinzeug
Material
Porcelain stoneware
Maßeinheit · Unit of measure
m ² 22,22 kg 5,56 pce
Pro Paket · Per box
0,72 m ² 16 kg 4 pce
Pro Palette · Per pallet
25,92 m ² 576 kg 36 box
Mindestabgabereinheit · Min. sales unit
P (box)
Berechnungseinheit · Calculation unit
m ²
P193



7,5 x 7,5 cm
□ 0,09 m² | 297 x 297 mm

2013
BM06
Grundfliese · Basic tile
Werkmaße · Dimensions (mm)
72 x 72 x 10 mm
Farbe · Colour
silver
Oberfläche · Finish
matt Metall-Beton · matt metal-concrete VilbostonePlus
Erzeugnisgruppe
Feinsteinzeug
Material
Porcelain stoneware
Maßeinheit · Unit of measure
m ² 20,90 kg 11 pce
Pro Paket · Per box
1 m ² 20,90 kg 11 pce
Pro Palette · Per pallet
36 m ² 752,40 kg 36 box
Mindestabgabereinheit · Min. sales unit
P (box)
Berechnungseinheit · Calculation unit
m ²
P175



7,5 x 7,5 cm
□ 0,09 m² | 297 x 297 mm

2013
BM10
Grundfliese · Basic tile
Werkmaße · Dimensions (mm)
72 x 72 x 10 mm
Farbe · Colour
pearl
Oberfläche · Finish
matt Metall-Beton · matt metal-concrete VilbostonePlus
Erzeugnisgruppe
Feinsteinzeug
Material
Porcelain stoneware
Maßeinheit · Unit of measure
m ² 20,90 kg 11 pce
Pro Paket · Per box
1 m ² 20,90 kg 11 pce
Pro Palette · Per pallet
36 m ² 752,40 kg 36 box
Mindestabgabereinheit · Min. sales unit
P (box)
Berechnungseinheit · Calculation unit
m ²
P175



7,5 x 7,5 cm
□ 0,09 m² | 297 x 297 mm

2013
BM70
Grundfliese · Basic tile
Werkmaße · Dimensions (mm)
72 x 72 x 10 mm
Farbe · Colour
bronze
Oberfläche · Finish
matt Metall-Beton · matt metal-concrete VilbostonePlus
Erzeugnisgruppe
Feinsteinzeug
Material
Porcelain stoneware
Maßeinheit · Unit of measure
m ² 20,90 kg 11 pce
Pro Paket · Per box
1 m ² 20,90 kg 11 pce
Pro Palette · Per pallet
36 m ² 752,40 kg 36 box
Mindestabgabereinheit · Min. sales unit
P (box)
Berechnungseinheit · Calculation unit
m ²
P175



7,5 x 7,5 cm
□ 0,09 m² | 297 x 297 mm

2013
BM40
Grundfliese · Basic tile
Werkmaße · Dimensions (mm)
72 x 72 x 10 mm
Farbe · Colour
iron
Oberfläche · Finish
matt Metall-Beton · matt metal-concrete VilbostonePlus
Erzeugnisgruppe
Feinsteinzeug
Material
Porcelain stoneware
Maßeinheit · Unit of measure
m ² 20,90 kg 11 pce
Pro Paket · Per box
1 m ² 20,90 kg 11 pce
Pro Palette · Per pallet
36 m ² 752,40 kg 36 box
Mindestabgabereinheit · Min. sales unit
P (box)
Berechnungseinheit · Calculation unit
m ²
P175

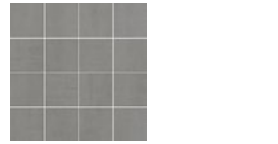

7,5 x 7,5 cm
□ 0,09 m² | 297 x 297 mm

2013
BM60
Grundfliese · Basic tile
Werkmaße · Dimensions (mm)
72 x 72 x 10 mm
Farbe · Colour
steel
Oberfläche · Finish
matt Metall-Beton · matt metal-concrete VilbostonePlus
Erzeugnisgruppe
Feinsteinzeug
Material
Porcelain stoneware
Maßeinheit · Unit of measure
m ² 20,90 kg 11 pce
Pro Paket · Per box
1 m ² 20,90 kg 11 pce
Pro Palette · Per pallet
36 m ² 752,40 kg 36 box
Mindestabgabereinheit · Min. sales unit
P (box)
Berechnungseinheit · Calculation unit
m ²
P175

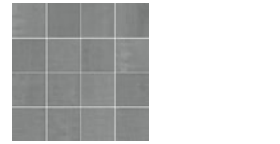

7,5 x 7,5 cm
□ 0,09 m² | 297 x 297 mm

2013
BM61
Grundfliese · Basic tile
Werkmaße · Dimensions (mm)
72 x 72 x 10 mm
Farbe · Colour
oxide
Oberfläche · Finish
matt Metall-Beton · matt metal-concrete VilbostonePlus
Erzeugnisgruppe
Feinsteinzeug
Material
Porcelain stoneware
Maßeinheit · Unit of measure
m ² 20,90 kg 11 pce
Pro Paket · Per box
1 m ² 20,90 kg 11 pce
Pro Palette · Per pallet
36 m ² 752,40 kg 36 box
Mindestabgabereinheit · Min. sales unit
P (box)
Berechnungseinheit · Calculation unit
m ²
P175

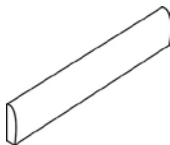

5 x 60 cm

2875
BM06, BM10, BM40
BM60, BM61, BM70
Werkmaße · Dimensions (mm)
48 x 597 x 10 mm
Farbe · Colour
-
Oberfläche · Finish
matt Metall-Beton · matt metal-concrete VilbostonePlus
Erzeugnisgruppe
Feinsteinzeug
Material
Porcelain stoneware
Maßeinheit · Unit of measure
m 1,05 kg 1,66 pce
Pro Paket · Per box
9,04 m 9,45 kg 15 pce
Pro Palette · Per pallet
433,74 m 453,60 kg 48 box
Mindestabgabereinheit · Min. sales unit
E (pce)
Berechnungseinheit · Calculation unit
Stück · piece
E60

METRO FLAIR Wohnen · Living

10 x 20 cm	10 x 20 cm	10 x 20 cm
1212	1212	1212
MW00	MW10	MW90
Grundfliese · Basic tile	Grundfliese · Basic tile	Grundfliese · Basic tile
Werksmaße · Dimensions (mm)	97 x 197 x 8 mm	97 x 197 x 8 mm
Farbe · Colour	snow	alabaster
Oberfläche · Finish	glänzend Unifarbene Glasur reliefiert · glossy Plain-coloured glaze relief	glänzend Unifarbene Glasur reliefiert · glossy Plain-coloured glaze relief
Erzeugnisgruppe	Steingut	Steingut
Material	Nonvitreous	Nonvitreous
Maßeinheit · Unit of measure	m ² 17,50 kg 50 pce	m ² 17,50 kg 50 pce
Pro Paket · Per box	0,40 m ² 7 kg 20 pce	0,40 m ² 7 kg 20 pce
Pro Palette · Per pallet	42 m ² 735 kg 105 box	42 m ² 735 kg 105 box
Mindestabgabereinheit · Min. sales unit	P (box)	P (box)
Berechnungseinheit · Calculation unit	m ²	m ²
Preisgruppe · Price group	P120	P121
	■ Aberdeen 2846 SB60, Oak Park 2792 HR90	■ Spotlight 2810 CM7M, Workshop 2871 BC30
10 x 10 cm	10 x 10 cm	10 x 10 cm
1210	1210	1210
MW00	MW10	MW90
Grundfliese · Basic tile	Grundfliese · Basic tile	Grundfliese · Basic tile
Werksmaße · Dimensions (mm)	97 x 97 x 8 mm	97 x 97 x 8 mm
Farbe · Colour	snow	alabaster
Oberfläche · Finish	glänzend Unifarbene Glasur reliefiert · glossy Plain-coloured glaze relief	glänzend Unifarbene Glasur reliefiert · glossy Plain-coloured glaze relief
Erzeugnisgruppe	Steingut	Steingut
Material	Nonvitreous	Nonvitreous
Maßeinheit · Unit of measure	m ² 18 kg 100 pce	m ² 18 kg 100 pce
Pro Paket · Per box	0,40 m ² 7,20 kg 40 pce	0,40 m ² 7,20 kg 40 pce
Pro Palette · Per pallet	42 m ² 756 kg 105 box	42 m ² 756 kg 105 box
Mindestabgabereinheit · Min. sales unit	P (box)	P (box)
Berechnungseinheit · Calculation unit	m ²	m ²
Preisgruppe · Price group	P145	P145

MY EARTH Wohnen · Living





60 x 60 cm	60 x 60 cm	60 x 60 cm	60 x 60 cm
2640	2640	2640	2640
RU10	RU20	RU60	RU90
Grundfliese · Basic tile	Grundfliese · Basic tile	Grundfliese · Basic tile	Grundfliese · Basic tile
Werksmaße · Dimensions (mm)	597 x 597 x 10 mm	597 x 597 x 10 mm	597 x 597 x 10 mm
Farbe · Colour	light beige	beige multicolor	grey multicolor
Oberfläche · Finish	matt Belebte Quarzitoptik reliefiert · matt Fresh quartzite look relief	matt Belebte Quarzitoptik reliefiert · matt Fresh quartzite look relief	matt Belebte Quarzitoptik reliefiert · matt Fresh quartzite look relief
Erzeugnisgruppe	VilbostonePlus	VilbostonePlus	VilbostonePlus
Material	Feinsteinzeug	Feinsteinzeug	Feinsteinzeug
Material	Porcelain stoneware	Porcelain stoneware	Porcelain stoneware
Maßeinheit · Unit of measure	m ² 22,22 kg 2,78 pce	m ² 22,22 kg 2,78 pce	m ² 22,22 kg 2,78 pce
Pro Paket · Per box	1,44 m ² 32 kg 4 pce	1,44 m ² 32 kg 4 pce	1,44 m ² 32 kg 4 pce
Pro Palette · Per pallet	43,20 m ² 960 kg 30 box	43,20 m ² 960 kg 30 box	43,20 m ² 960 kg 30 box
Mindestabgabereinheit · Min. sales unit	P (box)	P (box)	P (box)
Berechnungseinheit · Calculation unit	m ²	m ²	m ²
Preisgruppe · Price group	P99	P99	P99

Auch im Vilbogarden-Sortiment in 20 mm Dicke
Also in 20-mm thicknesses in the Vilbogarden range



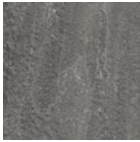
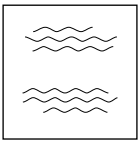

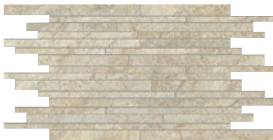





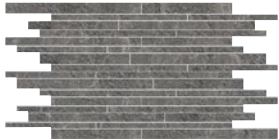













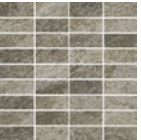



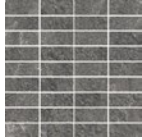

MY EARTH Wohnen · Living

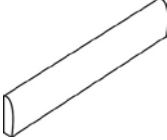
<p>Artikelnummer · Article number</p> <p>Warengruppe · Product group</p> <p>Werkmaße · Dimensions (mm)</p> <p>Farbe · Colour</p> <p>Oberfläche · Finish</p> <p>Erzeugnisgruppe</p> <p>Material</p> <p>Maßeinheit · Unit of measure</p> <p>Pro Paket · Per box</p> <p>Pro Palette · Per pallet</p> <p>Mindestabgabeneinheit · Min. sales unit</p> <p>Berechnungseinheit · Calculation unit</p> <p>Preisgruppe · Price group</p>	<p>60 x 60 cm</p> <p>2643</p> <p>RU10, RU20, RU60 </p> <p>RU90 </p> <p>Grundfliese · Basic tile</p> <p>597 x 597 x 10 mm</p> <p>-</p> <p>matt Belebte Quarzitoptik reliefiert · matt Fresh quartzite look relief</p> <p>VilbostonePlus</p> <p>Feinsteinzeug</p> <p>Porcelain stoneware</p> <p>m² 22,22 kg 2,78 pce</p> <p>1,44 m² 32 kg 4 pce</p> <p>43,20 m² 960 kg 30 box</p> <p>P (box)</p> <p>m²</p> <p>P99</p> <p>Auftragsbezogene Fertigung. Mindestbestellmenge 100 m². Lieferzeit auf Anfrage. Custom-made production. Minimum order quantity 100 m². Delivery time on request.</p>	<p>30 x 60 cm </p> <p>2641</p> <p>RU10 </p> <p>Grundfliese · Basic tile</p> <p>297 x 597 x 10 mm</p> <p>light beige</p> <p>matt Belebte Quarzitoptik reliefiert · matt Fresh quartzite look relief</p> <p>VilbostonePlus</p> <p>Feinsteinzeug</p> <p>Porcelain stoneware</p> <p>m² 22,22 kg 5,56 pce</p> <p>1,08 m² 24 kg 6 pce</p> <p>43,20 m² 960 kg 40 box</p> <p>P (box)</p> <p>m²</p> <p>P87</p>	<p>30 x 60 cm </p> <p>2641</p> <p>RU20 </p> <p>Grundfliese · Basic tile</p> <p>297 x 597 x 10 mm</p> <p>beige multicolor</p> <p>matt Belebte Quarzitoptik reliefiert · matt Fresh quartzite look relief</p> <p>VilbostonePlus</p> <p>Feinsteinzeug</p> <p>Porcelain stoneware</p> <p>m² 22,22 kg 5,56 pce</p> <p>1,08 m² 24 kg 6 pce</p> <p>43,20 m² 960 kg 40 box</p> <p>P (box)</p> <p>m²</p> <p>P87</p>	<p>30 x 60 cm </p> <p>2641</p> <p>RU60 </p> <p>Grundfliese · Basic tile</p> <p>297 x 597 x 10 mm</p> <p>grey multicolor</p> <p>matt Belebte Quarzitoptik reliefiert · matt Fresh quartzite look relief</p> <p>VilbostonePlus</p> <p>Feinsteinzeug</p> <p>Porcelain stoneware</p> <p>m² 22,22 kg 5,56 pce</p> <p>1,08 m² 24 kg 6 pce</p> <p>43,20 m² 960 kg 40 box</p> <p>P (box)</p> <p>m²</p> <p>P87</p>
	<p>30 x 60 cm </p> <p>2641</p> <p>RU90 </p> <p>Grundfliese · Basic tile</p> <p>297 x 597 x 10 mm</p> <p>anthracite multicolor</p> <p>matt Belebte Quarzitoptik reliefiert · matt Fresh quartzite look relief</p> <p>VilbostonePlus</p> <p>Feinsteinzeug</p> <p>Porcelain stoneware</p> <p>m² 22,22 kg 5,56 pce</p> <p>1,08 m² 24 kg 6 pce</p> <p>43,20 m² 960 kg 40 box</p> <p>P (box)</p> <p>m²</p> <p>P87</p>	<p>30 x 60 cm</p> <p>2644</p> <p>RU10, RU20, RU60 </p> <p>RU90 </p> <p>Grundfliese · Basic tile</p> <p>297 x 597 x 10 mm</p> <p>-</p> <p>matt Belebte Quarzitoptik reliefiert · matt Fresh quartzite look relief</p> <p>VilbostonePlus</p> <p>Feinsteinzeug</p> <p>Porcelain stoneware</p> <p>m² 22,22 kg 5,56 pce</p> <p>1,08 m² 24 kg 6 pce</p> <p>43,20 m² 960 kg 40 box</p> <p>P (box)</p> <p>m²</p> <p>P87</p>	<p>30 x 30 cm </p> <p>2642</p> <p>RU10 </p> <p>Grundfliese · Basic tile</p> <p>297 x 297 x 10 mm</p> <p>light beige</p> <p>matt Belebte Quarzitoptik reliefiert · matt Fresh quartzite look relief</p> <p>VilbostonePlus</p> <p>Feinsteinzeug</p> <p>Porcelain stoneware</p> <p>m² 22 kg 11 pce</p> <p>1 m² 22 kg 11 pce</p> <p>48 m² 1056 kg 48 box</p> <p>P (box)</p> <p>m²</p> <p>P120</p>	<p>30 x 30 cm </p> <p>2642</p> <p>RU20 </p> <p>Grundfliese · Basic tile</p> <p>297 x 297 x 10 mm</p> <p>beige multicolor</p> <p>matt Belebte Quarzitoptik reliefiert · matt Fresh quartzite look relief</p> <p>VilbostonePlus</p> <p>Feinsteinzeug</p> <p>Porcelain stoneware</p> <p>m² 22 kg 11 pce</p> <p>1 m² 22 kg 11 pce</p> <p>48 m² 1056 kg 48 box</p> <p>P (box)</p> <p>m²</p> <p>P120</p>
	<p>Auftragsbezogene Fertigung. Mindestbestellmenge 100 m². Lieferzeit auf Anfrage. Custom-made production. Minimum order quantity 100 m². Delivery time on request.</p>			

MY EARTH Wohnen · Living

				
	30 x 30 cm	30 x 30 cm	30 x 30 cm	20 x 60 cm
Artikelnummer · Article number	2642	2642	2645	2647
Warengruppe · Product group	RU60	RU90	RU10, RU20, RU60 RU90	RU10, RU20, RU60 RU90
Werkgröße · Dimensions (mm)	297 x 297 x 10 mm	297 x 297 x 10 mm	297 x 297 x 10 mm	197 x 597 x 10 mm
Farbe · Colour	grey multicolor	anthracite multicolor	-	-
Oberfläche · Finish	matt Belebte Quarzoptik reliefiert - matt Fresh quartzite look relief	matt Belebte Quarzoptik reliefiert - matt Fresh quartzite look relief	matt Belebte Quarzoptik reliefiert - matt Fresh quartzite look relief	matt Belebte Quarzoptik reliefiert - matt Fresh quartzite look relief
Erzeugnisgruppe	VilbostonePlus	VilbostonePlus	VilbostonePlus	VilbostonePlus
Material	Feinsteinzeug	Feinsteinzeug	Feinsteinzeug	Feinsteinzeug
Maßeinheit · Unit of measure	Porcelain stoneware	Porcelain stoneware	Porcelain stoneware	Porcelain stoneware
Pro Paket · Per box	m ² 22 kg 11 pce	m ² 22 kg 11 pce	m ² 22 kg 11 pce	m ² 21,67 kg 8,33 pce
Pro Palette · Per pallet	1 m ² 22 kg 11 pce	1 m ² 22 kg 11 pce	1 m ² 22 kg 11 pce	0,72 m ² 15,60 kg 6 pce
Mindestabgabeneinheit · Min. sales unit	48 m ² 1056 kg 48 box	48 m ² 1056 kg 48 box	48 m ² 1056 kg 48 box	43,20 m ² 936 kg 60 box
Berechnungseinheit · Calculation unit	P (box)	P (box)	P (box)	P (box)
Preisgruppe · Price group	m ²	m ²	m ²	m ²
	P120	P120	P120	P152
Auftragsbezogene Fertigung. Mindestbestellmenge 100 m ² . Lieferzeit auf Anfrage. Custom-made production. Minimum order quantity 100 m ² . Delivery time on request.				
				
	10 x 60 cm	30 x 50 cm	30 x 50 cm	30 x 50 cm
Artikelnummer · Article number	2646	2650	2650	2650
Warengruppe · Product group	RU10, RU20, RU60 RU90	RU10	RU20	RU60
Werkgröße · Dimensions (mm)	97 x 597 x 10 mm	298 x 498 x 10 mm	298 x 498 x 10 mm	298 x 498 x 10 mm
Farbe · Colour	-	light beige	beige multicolor	grey multicolor
Oberfläche · Finish	matt Belebte Quarzoptik reliefiert - matt Fresh quartzite look relief	matt Belebte Quarzoptik reliefiert - matt Fresh quartzite look relief	matt Belebte Quarzoptik reliefiert - matt Fresh quartzite look relief	matt Belebte Quarzoptik reliefiert - matt Fresh quartzite look relief
Erzeugnisgruppe	VilbostonePlus	VilbostonePlus	VilbostonePlus	VilbostonePlus
Material	Feinsteinzeug	Feinsteinzeug	Feinsteinzeug	Feinsteinzeug
Maßeinheit · Unit of measure	Porcelain stoneware	Porcelain stoneware	Porcelain stoneware	Porcelain stoneware
Pro Paket · Per box	m ² 23,33 kg 16,67 pce	m ² 18 kg 6,67 pce	m ² 18 kg 6,67 pce	m ² 18 kg 6,67 pce
Pro Palette · Per pallet	0,90 m ² 21 kg 15 pce	0,60 m ² 10,80 kg 4 pce	0,60 m ² 10,80 kg 4 pce	0,60 m ² 10,80 kg 4 pce
Mindestabgabeneinheit · Min. sales unit	43,20 m ² 1008 kg 48 box	18 m ² 324 kg 30 box	18 m ² 324 kg 30 box	18 m ² 324 kg 30 box
Berechnungseinheit · Calculation unit	P (box)	P (box)	P (box)	P (box)
Preisgruppe · Price group	m ²	m ²	m ²	m ²
	P160	P187	P187	P187
Auftragsbezogene Fertigung. Mindestbestellmenge 100 m ² . Lieferzeit auf Anfrage. Custom-made production. Minimum order quantity 100 m ² . Delivery time on request.				

MY EARTH Wohnen · Living

<p>30 x 50 cm</p> <p>0,15 m² 498 x 298 mm</p> <p>Artikelnummer · Article number</p> <p>Warengruppe · Product group</p> <p>Werkmaße · Dimensions (mm)</p> <p>Farbe · Colour</p> <p>Oberfläche · Finish</p> <p>Erzeugnisgruppe</p> <p>Material</p> <p>Maßeinheit · Unit of measure</p> <p>Pro Paket · Per box</p> <p>Pro Palette · Per pallet</p> <p>Mindestabgabereinheit · Min. sales unit</p> <p>Berechnungseinheit · Calculation unit</p> <p>Preisgruppe · Price group</p>	 <p>2650</p> <p>RU90    </p> <p>Dekor · Decor</p> <p>298 x 498 x 10 mm</p> <p>anthracite multicolor</p> <p>matt Belebte Quarzoptik reliefiert · matt Fresh quartzite look relief</p> <p>VilbostonePlus</p> <p>Feinsteinzeug</p> <p>Porcelain stoneware</p> <p>m² 18 kg 6,67 pce</p> <p>0,60 m² 10,80 kg 4 pce</p> <p>18 m² 324 kg 30 box</p> <p>P (box)</p> <p>m²</p> <p>P187</p>	 <p>3,3 x 7,5 cm</p> <p>0,09 m² 297 x 297 mm</p> <p>Artikelnummer · Article number</p> <p>Warengruppe · Product group</p> <p>Werkmaße · Dimensions (mm)</p> <p>Farbe · Colour</p> <p>Oberfläche · Finish</p> <p>Erzeugnisgruppe</p> <p>Material</p> <p>Maßeinheit · Unit of measure</p> <p>Pro Paket · Per box</p> <p>Pro Palette · Per pallet</p> <p>Mindestabgabereinheit · Min. sales unit</p> <p>Berechnungseinheit · Calculation unit</p> <p>Preisgruppe · Price group</p>	<p>2649</p> <p>RU10    </p> <p>Grundfliese · Basic tile</p> <p>31,20 x 72 x 10 mm</p> <p>light beige</p> <p>matt Belebte Quarzoptik reliefiert · matt Fresh quartzite look relief</p> <p>VilbostonePlus</p> <p>Feinsteinzeug</p> <p>Porcelain stoneware</p> <p>m² 21,45 kg 11 pce</p> <p>1 m² 21,45 kg 11 pce</p> <p>24 m² 514,80 kg 24 box</p> <p>P (box)</p> <p>m²</p> <p>P209</p>	 <p>3,3 x 7,5 cm</p> <p>0,09 m² 297 x 297 mm</p> <p>Artikelnummer · Article number</p> <p>Warengruppe · Product group</p> <p>Werkmaße · Dimensions (mm)</p> <p>Farbe · Colour</p> <p>Oberfläche · Finish</p> <p>Erzeugnisgruppe</p> <p>Material</p> <p>Maßeinheit · Unit of measure</p> <p>Pro Paket · Per box</p> <p>Pro Palette · Per pallet</p> <p>Mindestabgabereinheit · Min. sales unit</p> <p>Berechnungseinheit · Calculation unit</p> <p>Preisgruppe · Price group</p>	<p>2649</p> <p>RU20    </p> <p>Grundfliese · Basic tile</p> <p>31,20 x 72 x 10 mm</p> <p>beige multicolor</p> <p>matt Belebte Quarzoptik reliefiert · matt Fresh quartzite look relief</p> <p>VilbostonePlus</p> <p>Feinsteinzeug</p> <p>Porcelain stoneware</p> <p>m² 21,45 kg 11 pce</p> <p>1 m² 21,45 kg 11 pce</p> <p>24 m² 514,80 kg 24 box</p> <p>P (box)</p> <p>m²</p> <p>P209</p>	 <p>3,3 x 7,5 cm</p> <p>0,09 m² 297 x 297 mm</p> <p>Artikelnummer · Article number</p> <p>Warengruppe · Product group</p> <p>Werkmaße · Dimensions (mm)</p> <p>Farbe · Colour</p> <p>Oberfläche · Finish</p> <p>Erzeugnisgruppe</p> <p>Material</p> <p>Maßeinheit · Unit of measure</p> <p>Pro Paket · Per box</p> <p>Pro Palette · Per pallet</p> <p>Mindestabgabereinheit · Min. sales unit</p> <p>Berechnungseinheit · Calculation unit</p> <p>Preisgruppe · Price group</p>	<p>2649</p> <p>RU60    </p> <p>Grundfliese · Basic tile</p> <p>31,20 x 72 x 10 mm</p> <p>grey multicolor</p> <p>matt Belebte Quarzoptik reliefiert · matt Fresh quartzite look relief</p> <p>VilbostonePlus</p> <p>Feinsteinzeug</p> <p>Porcelain stoneware</p> <p>m² 21,45 kg 11 pce</p> <p>1 m² 21,45 kg 11 pce</p> <p>24 m² 514,80 kg 24 box</p> <p>P (box)</p> <p>m²</p> <p>P209</p>
<p>Artikelnummer · Article number</p> <p>Warengruppe · Product group</p> <p>Werkmaße · Dimensions (mm)</p> <p>Farbe · Colour</p> <p>Oberfläche · Finish</p> <p>Erzeugnisgruppe</p> <p>Material</p> <p>Maßeinheit · Unit of measure</p> <p>Pro Paket · Per box</p> <p>Pro Palette · Per pallet</p> <p>Mindestabgabereinheit · Min. sales unit</p> <p>Berechnungseinheit · Calculation unit</p> <p>Preisgruppe · Price group</p>	 <p>3,3 x 7,5 cm</p> <p>0,09 m² 297 x 297 mm</p> <p>2649</p> <p>RU90    </p> <p>Grundfliese · Basic tile</p> <p>31,20 x 72 x 10 mm</p> <p>anthracite multicolor</p> <p>matt Belebte Quarzoptik reliefiert · matt Fresh quartzite look relief</p> <p>VilbostonePlus</p> <p>Feinsteinzeug</p> <p>Porcelain stoneware</p> <p>m² 21,45 kg 11 pce</p> <p>1 m² 21,45 kg 11 pce</p> <p>24 m² 514,80 kg 24 box</p> <p>P (box)</p> <p>m²</p> <p>P209</p>	 <p>7,5 x 60 cm</p> <p>2872</p> <p>RU10, RU20, RU60    </p> <p>RU90    </p> <p>Sockel · Skirting</p> <p>72 x 597 x 10 mm</p> <p>-</p> <p>matt Belebte Quarzoptik reliefiert · matt Fresh quartzite look relief</p> <p>VilbostonePlus</p> <p>Feinsteinzeug</p> <p>Porcelain stoneware</p> <p>m 1,64 kg 1,67 pce</p> <p>11,98 m 19,60 kg 20 pce</p> <p>574,85 m 940,80 kg 48 box</p> <p>E (pce)</p> <p>Stück · piece</p> <p>E53</p>					









NATURAL BLEND *Excellence* by Villeroy & Boch

Concept³

	40 x 120 cm	40 x 120 cm	30 x 60 cm	30 x 60 cm
Artikelnummer - Article number	1440	1440	1581	1581
	LY00	LY10	LY00	LY10
Warengruppe - Product group	Grundfliese - Basic tile	Grundfliese - Basic tile	Grundfliese - Basic tile	Grundfliese - Basic tile
Werkmaße - Dimensions (mm)	397 x 1197 x 11 mm	397 x 1197 x 11 mm	297 x 597 x 9 mm	297 x 597 x 9 mm
Farbe - Colour	stone white	golden sand	stone white	golden sand
Oberfläche - Finish	matt Steinstruktur - matt stone texture CeramicPlus	matt Steinstruktur - matt stone texture CeramicPlus	matt Steinstruktur - matt stone texture CeramicPlus	matt Steinstruktur - matt stone texture CeramicPlus
Erzeugnisgruppe	Steingut	Steingut	Steingut	Steingut
Material	Nonvitreous	Nonvitreous	Nonvitreous	Nonvitreous
Maßeinheit - Unit of measure	m ² 19,04 kg 2,08 pce	m ² 19,04 kg 2,08 pce	m ² 15,56 kg 5,56 pce	m ² 15,56 kg 5,56 pce
Pro Paket - Per box	1,44 m ² 27,42 kg 3 pce	1,44 m ² 27,42 kg 3 pce	1,62 m ² 25,20 kg 9 pce	1,62 m ² 25,20 kg 9 pce
Pro Palette - Per pallet	25,92 m ² 493,56 kg 18 box	25,92 m ² 493,56 kg 18 box	51,84 m ² 806,40 kg 32 box	51,84 m ² 806,40 kg 32 box
Mindestabgabereinheit - Min. sales unit	P (box)	P (box)	P (box)	P (box)
Berechnungseinheit - Calculation unit	m ²	m ²	m ²	m ²
Preisgruppe - Price group	P120	P120	P87	P87
	60 x 120 cm	60 x 120 cm	30 x 120 cm	30 x 120 cm
Artikelnummer - Article number	2730	2730	2356	2356
	LY20	LY60	LY20	LY60
Warengruppe - Product group	Grundfliese - Basic tile	Grundfliese - Basic tile	Grundfliese - Basic tile	Grundfliese - Basic tile
Werkmaße - Dimensions (mm)	597 x 1197 x 10 mm	597 x 1197 x 10 mm	297 x 1197 x 10 mm	297 x 1197 x 10 mm
Farbe - Colour	sunny cliff	stone grey	sunny cliff	stone grey
Oberfläche - Finish	matt Steinstruktur - matt stone texture VilbostonePlus	matt Steinstruktur - matt stone texture VilbostonePlus	matt Steinstruktur - matt stone texture VilbostonePlus	matt Steinstruktur - matt stone texture VilbostonePlus
Erzeugnisgruppe	Feinsteinzeug	Feinsteinzeug	Feinsteinzeug	Feinsteinzeug
Material	Porcelain stoneware	Porcelain stoneware	Porcelain stoneware	Porcelain stoneware
Maßeinheit - Unit of measure	m ² 21,28 kg 1,39 pce	m ² 21,28 kg 1,39 pce	m ² 22,22 kg 2,78 pce	m ² 22,22 kg 2,78 pce
Pro Paket - Per box	1,44 m ² 30,64 kg 2 pce	1,44 m ² 30,64 kg 2 pce	1,44 m ² 32 kg 4 pce	1,44 m ² 32 kg 4 pce
Pro Palette - Per pallet	43,2 m ² 919,2 kg 30 box	43,2 m ² 919,2 kg 30 box	43,20 m ² 960 kg 30 box	43,20 m ² 960 kg 30 box
Mindestabgabereinheit - Min. sales unit	P (box)	P (box)	P (box)	P (box)
Berechnungseinheit - Calculation unit	m ²	m ²	m ²	m ²
Preisgruppe - Price group	P110	P110	P134	P134

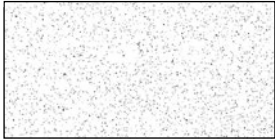
NATURAL BLEND *Excellence* by Villeroy & Boch

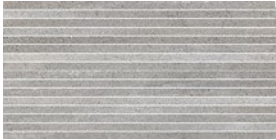
Concept³

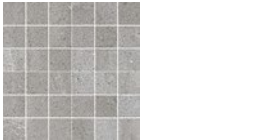
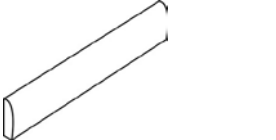
				
	60 x 60 cm	60 x 60 cm	30 x 60 cm	30 x 60 cm
Artikelnummer · Article number	2660	2660	2394	2394
Warengruppe · Product group	LY20	LY60	LY20	LY60
Werkgröße · Dimensions (mm)	Grundfliese · Basic tile 597 x 597 x 9 mm	Grundfliese · Basic tile 597 x 597 x 9 mm	Grundfliese · Basic tile 297 x 597 x 9 mm	Grundfliese · Basic tile 297 x 597 x 9 mm
Farbe · Colour	sunny cliff	stone grey	sunny cliff	stone grey
Oberfläche · Finish	matt Steinstruktur · matt stone texture VilbostonePlus	matt Steinstruktur · matt stone texture VilbostonePlus	matt Steinstruktur · matt stone texture VilbostonePlus	matt Steinstruktur · matt stone texture VilbostonePlus
Erzeugnisgruppe	Feinsteinzeug	Feinsteinzeug	Feinsteinzeug	Feinsteinzeug
Material	Porcelain stoneware	Porcelain stoneware	Porcelain stoneware	Porcelain stoneware
Maßeinheit · Unit of measure	m ² 20 kg 2,78 pce	m ² 20 kg 2,78 pce	m ² 20 kg 5,56 pce	m ² 20 kg 5,56 pce
Pro Paket · Per box	1,44 m ² 28,80 kg 4 pce	1,44 m ² 28,80 kg 4 pce	1,08 m ² 21,60 kg 6 pce	1,08 m ² 21,60 kg 6 pce
Pro Palette · Per pallet	43,20 m ² 864 kg 30 box	43,20 m ² 864 kg 30 box	43,20 m ² 864 kg 40 box	43,20 m ² 864 kg 40 box
Mindestabgabereinheit · Min. sales unit	P (box)	P (box)	P (box)	P (box)
Berechnungseinheit · Calculation unit	m ²	m ²	m ²	m ²
Preisgruppe · Price group	P99	P99	P87	P87
				
	30 x 60 cm	1,7 x 60 cm	1,7 x 60 cm	5 x 5 cm
Artikelnummer · Article number	2680	2024	2024	2030
Warengruppe · Product group	LY20, LY60	LY20	LY60	LY20
Werkgröße · Dimensions (mm)	Grundfliese · Basic tile 297 x 597 x 9 mm	Dekor · Decor 16,68 x 597 x 9 mm	Dekor · Decor 16,68 x 597 x 9 mm	Grundfliese · Basic tile 48 x 48 x 9 mm
Farbe · Colour	-	sunny cliff	stone grey	sunny cliff
Oberfläche · Finish	matt Steinstruktur reliefiert · matt stone texture relief VilbostonePlus	matt Steinstruktur · matt stone texture VilbostonePlus	matt Steinstruktur · matt stone texture VilbostonePlus	matt Steinstruktur · matt stone texture VilbostonePlus
Erzeugnisgruppe	Feinsteinzeug	Feinsteinzeug	Feinsteinzeug	Feinsteinzeug
Material	Porcelain stoneware	Porcelain stoneware	Porcelain stoneware	Porcelain stoneware
Maßeinheit · Unit of measure	m ² 20 kg 5,56 pce	m ² 18 kg 5,56 pce	m ² 18 kg 5,56 pce	m ² 19,80 kg 11 pce
Pro Paket · Per box	1,08 m ² 21,60 kg 6 pce	0,90 m ² 16,20 kg 5 pce	0,90 m ² 16,20 kg 5 pce	1,09 m ² 21,60 kg 12 pce
Pro Palette · Per pallet	43,20 m ² 864 kg 40 box	32,40 m ² 583,20 kg 36 box	32,40 m ² 583,20 kg 36 box	39,27 m ² 777,60 kg 36 box
Mindestabgabereinheit · Min. sales unit	P (box)	P (box)	P (box)	P (box)
Berechnungseinheit · Calculation unit	m ²	m ²	m ²	m ²
Preisgruppe · Price group	P87	P196	P196	P190
				
	5 x 5 cm	7,5 x 60 cm		
Artikelnummer · Article number	2030	2872		
Warengruppe · Product group	LY60	LY20, LY60		
Werkgröße · Dimensions (mm)	Grundfliese · Basic tile 48 x 48 x 9 mm	Sockel · Skirting 72 x 597 x 9 mm		
Farbe · Colour	stone grey	-		
Oberfläche · Finish	matt Steinstruktur · matt stone texture VilbostonePlus	matt Steinstruktur · matt stone texture VilbostonePlus		
Erzeugnisgruppe	Feinsteinzeug	Feinsteinzeug		
Material	Porcelain stoneware	Porcelain stoneware		
Maßeinheit · Unit of measure	m ² 19,80 kg 11 pce	m 1,46 kg 1,66 pce		
Pro Paket · Per box	1,09 m ² 21,60 kg 12 pce	13,25 m 19,36 kg 22 pce		
Pro Palette · Per pallet	39,27 m ² 777,60 kg 36 box	636,15 m 929,28 kg 48 box		
Mindestabgabereinheit · Min. sales unit	P (box)	E (pce)		
Berechnungseinheit · Calculation unit	m ²	Stück · piece		
Preisgruppe · Price group	P190	E53		

Auftragsbezogene Fertigung. Mindestbestellmenge 100 m². Lieferzeit auf Anfrage.
Custom-made production. Minimum order quantity 100 m². Delivery time on request.

NOCTURNE *Excellence* by Villeroy & Boch



120 x 260 cm



120 x 260 cm



Artikelnummer · Article number	2962	OPTIMA 6 mm	2962	OPTIMA 6 mm
Warengruppe · Product group	ZN1P		ZN2P	
Werksmaße · Dimensions (mm)	Grundfliese · Basic tile		Grundfliese · Basic tile	
Farbe · Colour	1198 x 2598 x 6 mm		1198 x 2598 x 6 mm	
Oberfläche · Finish	white		white gold	
Erzeugnisgruppe	poliert · polished		poliert · polished	
Material	Feinsteinzeug glasiert		Feinsteinzeug glasiert	
Maßeinheit · Unit of measure	Glazed porcelain stoneware		Glazed porcelain stoneware	
Pro Paket · Per box	m ² 14,10 kg 0,32 pce		m ² 14,10 kg 0,32 pce	
Pro Palette · Per pallet	3,12 m ² 43,99 kg 1 pce		3,12 m ² 43,99 kg 1 pce	
Mindestabgabereinheit · Min. sales unit	56,16 m ² 791,82 kg 18 box		56,16 m ² 791,82 kg 18 box	
Berechnungseinheit · Calculation unit	Stück · piece		Stück · piece	
Preisgruppe · Price group	m ²		m ²	
	P168		P168	

Für Wandanwendungen empfohlen.
Recommended for wall coverings.

NOCTURNE *Excellence* by Villeroy & Boch



120 x 260 cm



3

Artikelnummer · Article number	2962	OPTIMA 6 mm
Warengruppe · Product group	ZN9P	
Werksmaße · Dimensions (mm)	Grundfliese · Basic tile	
Farbe · Colour	1198 x 2598 x 6 mm	
Oberfläche · Finish	black	
Erzeugnisgruppe	poliert · polished	
Material	Feinsteinzeug glasiert	
Maßeinheit · Unit of measure	Glazed porcelain stoneware	
Pro Paket · Per box	m ² 14,10 kg 0,32 pce	
Pro Palette · Per pallet	3,12 m ² 43,99 kg 1 pce	
Mindestabgabereinheit · Min. sales unit	56,16 m ² 791,82 kg 18 box	
Berechnungseinheit · Calculation unit	Stück · piece	
Preisgruppe · Price group	m ²	P168

Für Wandanwendungen empfohlen.
Recommended for wall coverings.

NOCTURNE *Excellence* by Villeroy & Boch



120 x 120 cm



120 x 120 cm



Artikelnummer · Article number	2961	OPTIMA 6 mm
Warengruppe · Product group	ZN1P	
Werksmaße · Dimensions (mm)	Grundfliese · Basic tile	
Farbe · Colour	1198 x 1198 x 6 mm	
Oberfläche · Finish	white	
Erzeugnisgruppe	poliert · polished	
Material	Feinsteinzeug glasiert	
Maßeinheit · Unit of measure	Glazed porcelain stoneware	
Pro Paket · Per box	m ² 14,10 kg 0,69 pce	
Pro Palette · Per pallet	2,88 m ² 40,60 kg 2 pce	
Mindestabgabereinheit · Min. sales unit	69,12 m ² 974,40 kg 24 box	
Berechnungseinheit · Calculation unit	P (box)	
Preisgruppe · Price group	m ²	P158

Artikelnummer · Article number	2961	OPTIMA 6 mm
Warengruppe · Product group	ZN2P	
Werksmaße · Dimensions (mm)	Grundfliese · Basic tile	
Farbe · Colour	1198 x 1198 x 6 mm	
Oberfläche · Finish	white gold	
Erzeugnisgruppe	poliert · polished	
Material	Feinsteinzeug glasiert	
Maßeinheit · Unit of measure	Glazed porcelain stoneware	
Pro Paket · Per box	m ² 14,10 kg 0,69 pce	
Pro Palette · Per pallet	2,88 m ² 40,60 kg 2 pce	
Mindestabgabereinheit · Min. sales unit	69,12 m ² 974,40 kg 24 box	
Berechnungseinheit · Calculation unit	P (box)	
Preisgruppe · Price group	m ²	P158



120 x 120 cm



Artikelnummer · Article number	2961	OPTIMA 6 mm
Warengruppe · Product group	ZN9P	
Werksmaße · Dimensions (mm)	Grundfliese · Basic tile	
Farbe · Colour	1198 x 1198 x 6 mm	
Oberfläche · Finish	black	
Erzeugnisgruppe	poliert · polished	
Material	Feinsteinzeug glasiert	
Maßeinheit · Unit of measure	Glazed porcelain stoneware	
Pro Paket · Per box	m ² 14,10 kg 0,69 pce	
Pro Palette · Per pallet	2,88 m ² 40,60 kg 2 pce	
Mindestabgabereinheit · Min. sales unit	69,12 m ² 974,40 kg 24 box	
Berechnungseinheit · Calculation unit	P (box)	
Preisgruppe · Price group	m ²	P158

NOCTURNE *Excellence* by Villeroy & Boch

	60 x 120 cm	60 x 120 cm	60 x 120 cm	60,5 x 120,5 cm
Artikelnummer · Article number	2730	2730	2730	2730
	ZN1L	ZN2L	ZN9L	ZN1P, ZN2P ZN9P
Warengruppe · Product group	Grundfliese · Basic tile	Grundfliese · Basic tile	Grundfliese · Basic tile	Grundfliese · Basic tile
Werkmaße · Dimensions (mm)	597 x 1197 x 9 mm	597 x 1197 x 9 mm	597 x 1197 x 9 mm	600 x 1200 x 11 mm
Farbe · Colour	white	white-gold	black	-
Oberfläche · Finish	geläpft/anpoliert Marmorstruktur · rough-polished marble texture	geläpft/anpoliert Marmorstruktur · rough-polished marble texture	geläpft/anpoliert Marmorstruktur · rough-polished marble texture	poliert Marmorstruktur · polished marble texture
Erzeugnisgruppe	Feinsteinzeug glasiert	Feinsteinzeug glasiert	Feinsteinzeug glasiert	Feinsteinzeug glasiert
Material	Glazed porcelain stoneware	Glazed porcelain stoneware	Glazed porcelain stoneware	Glazed porcelain stoneware
Maßeinheit · Unit of measure	m ² 19,49 kg 1,39 pce	m ² 19,49 kg 1,39 pce	m ² 19,49 kg 1,39 pce	m ² 22,22 kg 1,39 pce
Pro Paket · Per box	1,44 m ² 28,06 kg 2 pce	1,44 m ² 28,06 kg 2 pce	1,44 m ² 28,06 kg 2 pce	1,44 m ² 32 kg 2 pce
Pro Palette · Per pallet	43,2 m ² 841,8 kg 30 box	43,2 m ² 841,8 kg 30 box	43,2 m ² 841,8 kg 30 box	38,88 m ² 864 kg 27 box
Mindestabgabeneinheit · Min. sales unit	P (box)	P (box)	P (box)	P (box)
Berechnungseinheit · Calculation unit	m ²	m ²	m ²	m ²
Preisgruppe · Price group	P124	P124	P124	P130
	60 x 60 cm	60 x 60 cm	60 x 60 cm	60 x 60 cm
Artikelnummer · Article number	2660	2660	2660	2660
	ZN1L	ZN2L	ZN9L	ZN1P, ZN2P ZN9P
Warengruppe · Product group	Grundfliese · Basic tile	Grundfliese · Basic tile	Grundfliese · Basic tile	Grundfliese · Basic tile
Werkmaße · Dimensions (mm)	597 x 597 x 9 mm	597 x 597 x 9 mm	597 x 597 x 9 mm	598 x 598 x 9 mm
Farbe · Colour	white	white-gold	black	-
Oberfläche · Finish	geläpft/anpoliert Marmorstruktur · rough-polished marble texture	geläpft/anpoliert Marmorstruktur · rough-polished marble texture	geläpft/anpoliert Marmorstruktur · rough-polished marble texture	poliert Marmorstruktur · polished marble texture
Erzeugnisgruppe	Feinsteinzeug glasiert	Feinsteinzeug glasiert	Feinsteinzeug glasiert	Feinsteinzeug glasiert
Material	Glazed porcelain stoneware	Glazed porcelain stoneware	Glazed porcelain stoneware	Glazed porcelain stoneware
Maßeinheit · Unit of measure	m ² 21,44 kg 2,78 pce	m ² 21,44 kg 2,78 pce	m ² 21,44 kg 2,78 pce	m ² 21,44 kg 2,78 pce
Pro Paket · Per box	1,44 m ² 30,88 kg 4 pce	1,44 m ² 30,88 kg 4 pce	1,44 m ² 30,88 kg 4 pce	1,44 m ² 30,88 kg 4 pce
Pro Palette · Per pallet	43,20 m ² 926,40 kg 30 box	43,20 m ² 926,40 kg 30 box	43,20 m ² 926,40 kg 30 box	43,20 m ² 926,40 kg 30 box
Mindestabgabeneinheit · Min. sales unit	P (box)	P (box)	P (box)	P (box)
Berechnungseinheit · Calculation unit	m ²	m ²	m ²	m ²
Preisgruppe · Price group	P124	P124	P124	P130

NOCTURNE *Excellence* by Villeroy & Boch



60 x 60 cm
□ 0,36 m² | 597 x 597 mm

2044
ZN1P



60 x 60 cm
□ 0,36 m² | 597 x 597 mm

2044
ZN9P



21 x 21 cm
□ 0,04 m² | 210 x 210 mm

2041
ZN2P



20 x 23 cm
□ 0,05 m² | 200 x 230 mm

2043
ZN1P

Artikelnummer - Article number
Warengruppe - Product group
Werkmaße - Dimensions (mm)
Farbe - Colour
Oberfläche - Finish
Erzeugnisgruppe
Material
Maßeinheit - Unit of measure
Pro Paket - Per box
Pro Palette - Per pallet
Mindestabgabeneinheit - Min. sales unit
Berechnungseinheit - Calculation unit
Preisgruppe - Price group

Dekor · Decor
597 x 597 x 9 mm
white
poliert Marmorstruktur · polished marble texture
Feinsteinzeug glasiert
Glazed porcelain stoneware
m ² 20,83 kg 2,78 pce
1,08 m ² 22,50 kg 3 pce
43,20 m ² 900 kg 40 box
P (box)
m ²
P204

Dekor · Decor
597 x 597 x 9 mm
black
poliert Marmorstruktur · polished marble texture
Feinsteinzeug glasiert
Glazed porcelain stoneware
m ² 20,83 kg 2,78 pce
1,08 m ² 22,50 kg 3 pce
43,20 m ² 900 kg 40 box
P (box)
m ²
P204

Dekor · Decor
210 x 210 x 9 mm
gold
poliert Marmorstruktur · polished marble texture
Feinsteinzeug glasiert
Glazed porcelain stoneware
m ² 18,14 kg 22,68 pce
0,31 m ² 5,60 kg 7 pce
27,78 m ² 504 kg 90 box
P (box)
m ²
P204

Dekor · Decor
200 x 230 x 9 mm
white
poliert Marmorstruktur · polished marble texture
Feinsteinzeug glasiert
Glazed porcelain stoneware
m ² 17,39 kg 21,74 pce
0,32 m ² 5,60 kg 7 pce
28,98 m ² 504 kg 90 box
P (box)
m ²
P204

Fliese für Wandanwendungen, nicht für Außen- und Naßbereiche geeignet.
Tile for wall applications, not suitable for outdoor and wet areas.



20 x 23 cm
□ 0,05 m² | 200 x 230 mm

2043
ZN8P



20 x 23 cm
□ 0,05 m² | 200 x 230 mm

2043
ZN9P



20 x 25 cm
□ 0,08 m² | 250 x 300 mm

2045
ZN1P



20 x 25 cm
□ 0,08 m² | 250 x 300 mm

2045
ZN9P

Artikelnummer - Article number
Warengruppe - Product group
Werkmaße - Dimensions (mm)
Farbe - Colour
Oberfläche - Finish
Erzeugnisgruppe
Material
Maßeinheit - Unit of measure
Pro Paket - Per box
Pro Palette - Per pallet
Mindestabgabeneinheit - Min. sales unit
Berechnungseinheit - Calculation unit
Preisgruppe - Price group

Dekor · Decor
200 x 230 x 9 mm
silver
poliert Marmorstruktur · polished marble texture
Feinsteinzeug glasiert
Glazed porcelain stoneware
m ² 17,39 kg 21,74 pce
0,32 m ² 5,60 kg 7 pce
28,98 m ² 504 kg 90 box
P (box)
m ²
P204

Dekor · Decor
200 x 230 x 9 mm
black
poliert Marmorstruktur · polished marble texture
Feinsteinzeug glasiert
Glazed porcelain stoneware
m ² 17,39 kg 21,74 pce
0,32 m ² 5,60 kg 7 pce
28,98 m ² 504 kg 90 box
P (box)
m ²
P204

Dekor · Decor
200 x 250 x 9 mm
white
poliert Marmorstruktur · polished marble texture
Feinsteinzeug glasiert
Glazed porcelain stoneware
m ² 15,40 kg 20 pce
0,35 m ² 5,39 kg 7 pce
23,10 m ² 355,74 kg 66 box
P (box)
m ²
P204

Dekor · Decor
200 x 250 x 9 mm
black
poliert Marmorstruktur · polished marble texture
Feinsteinzeug glasiert
Glazed porcelain stoneware
m ² 15,40 kg 20 pce
0,35 m ² 5,39 kg 7 pce
23,10 m ² 355,74 kg 66 box
P (box)
m ²
P204

Fliese für Wandanwendungen, nicht für Außen- und Naßbereiche geeignet.
Tile for wall applications, not suitable for outdoor and wet areas.

Fliese für Wandanwendungen, nicht für Außen- und Naßbereiche geeignet.
Tile for wall applications, not suitable for outdoor and wet areas.

NORTHFIELD Wohnen Basis · Living Basis

60 x 60 cm	60 x 60 cm	60 x 60 cm	
2336	2336	2336	
RD70	RD60	RD90	
Grundfliese · Basic tile	Grundfliese · Basic tile	Grundfliese · Basic tile	
Werkmaße · Dimensions (mm) 604 x 604 x 9 mm	604 x 604 x 9 mm	604 x 604 x 9 mm	
Farbe · Colour greige	grey	anthracite	
Oberfläche · Finish matt reliefiert · matt relief	matt reliefiert · matt relief	matt reliefiert · matt relief	
Erzeugnisgruppe VilbostonePlus	VilbostonePlus	VilbostonePlus	
Material Feinsteinzeug	Feinsteinzeug	Feinsteinzeug	
Material Porcelain stoneware	Porcelain stoneware	Porcelain stoneware	
Maßeinheit · Unit of measure m ² 19,33 kg 2,78 pce	m ² 19,33 kg 2,78 pce	m ² 19,33 kg 2,78 pce	
Pro Paket · Per box 1,44 m ² 27,84 kg 4 pce	1,44 m ² 27,84 kg 4 pce	1,44 m ² 27,84 kg 4 pce	
Pro Palette · Per pallet 43,20 m ² 835,20 kg 30 box	43,20 m ² 835,20 kg 30 box	43,20 m ² 835,20 kg 30 box	
Mindestabgabereinheit · Min. sales unit P (box)	P (box)	P (box)	
Berechnungseinheit · Calculation unit m ²	m ²	m ²	
Preisgruppe · Price group P91	P91	P91	
30 x 60 cm	30 x 60 cm	30 x 60 cm	
2337	2337	2337	
RD70	RD60	RD90	
Grundfliese · Basic tile	Grundfliese · Basic tile	Grundfliese · Basic tile	
Werkmaße · Dimensions (mm) 297 x 597 x 9 mm	297 x 597 x 9 mm	297 x 597 x 9 mm	
Farbe · Colour greige	grey	anthracite	
Oberfläche · Finish matt reliefiert · matt relief	matt reliefiert · matt relief	matt reliefiert · matt relief	
Erzeugnisgruppe VilbostonePlus	VilbostonePlus	VilbostonePlus	
Material Feinsteinzeug	Feinsteinzeug	Feinsteinzeug	
Material Porcelain stoneware	Porcelain stoneware	Porcelain stoneware	
Maßeinheit · Unit of measure m ² 19,22 kg 5,56 pce	m ² 19,22 kg 5,56 pce	m ² 19,22 kg 5,56 pce	
Pro Paket · Per box 1,08 m ² 20,76 kg 6 pce	1,08 m ² 20,76 kg 6 pce	1,08 m ² 20,76 kg 6 pce	
Pro Palette · Per pallet 43,20 m ² 830,40 kg 40 box	43,20 m ² 830,40 kg 40 box	43,20 m ² 830,40 kg 40 box	
Mindestabgabereinheit · Min. sales unit P (box)	P (box)	P (box)	
Berechnungseinheit · Calculation unit m ²	m ²	m ²	
Preisgruppe · Price group P87	P87	P87	
5 x 5 cm	5 x 5 cm	5 x 5 cm	8 x 60 cm
<input type="checkbox"/> 0,09 m ² 298 x 298 mm	<input type="checkbox"/> 0,09 m ² 298 x 298 mm	<input type="checkbox"/> 0,09 m ² 298 x 298 mm	
2030	2030	2030	2872
RD70	RD60	RD90	RD60, RD70, RD90
Grundfliese · Basic tile	Grundfliese · Basic tile	Grundfliese · Basic tile	Sockel · Skirting
Werkmaße · Dimensions (mm) 48 x 48 x 9 mm	48 x 48 x 9 mm	48 x 48 x 9 mm	80 x 597 x 9 mm
Farbe · Colour greige	grey	anthracite	-
Oberfläche · Finish matt reliefiert · matt relief	matt reliefiert · matt relief	matt reliefiert · matt relief	matt reliefiert · matt relief
Erzeugnisgruppe VilbostonePlus	VilbostonePlus	VilbostonePlus	VilbostonePlus
Material Feinsteinzeug	Feinsteinzeug	Feinsteinzeug	Feinsteinzeug
Material Porcelain stoneware	Porcelain stoneware	Porcelain stoneware	Porcelain stoneware
Maßeinheit · Unit of measure m ² 20,90 kg 11 pce	m ² 20,90 kg 11 pce	m ² 20,90 kg 11 pce	m 1,55 kg 1,67 pce
Pro Paket · Per box 1,09 m ² 22,80 kg 12 pce	1,09 m ² 22,80 kg 12 pce	1,09 m ² 22,80 kg 12 pce	12,57 m 19,53 kg 21 pce
Pro Palette · Per pallet 39,27 m ² 820,80 kg 36 box	39,27 m ² 820,80 kg 36 box	39,27 m ² 820,80 kg 36 box	603,59 m 937,44 kg 48 box
Mindestabgabereinheit · Min. sales unit P (box)	P (box)	P (box)	E (pce)
Berechnungseinheit · Calculation unit m ²	m ²	m ²	Stück · piece
Preisgruppe · Price group P168	P168	P168	E50

OAK PARK Wohnen Basis · Living Basis



30 x 120 cm



Artikelnummer · Article number	2793
Warengruppe · Product group	Grundfliese · Basic tile
Werksmaße · Dimensions (mm)	298 x 1200 x 9 mm
Farbe · Colour	farina
Oberfläche · Finish	matt Ruhige Eichenholzstruktur reliefiert · matt Calming oak wood structure relief VilbostonePlus
Erzeugnisgruppe	Feinsteinzeug
Material	Porcelain stoneware
Maßeinheit · Unit of measure	m ² 22,22 kg 2,78 pce
Pro Paket · Per box	1,44 m ² 32 kg 4 pce
Pro Palette · Per pallet	51,84 m ² 1152 kg 36 box
Mindestabgabereinheit · Min. sales unit	P (box)
Berechnungseinheit · Calculation unit	m ²
Preisgruppe · Price group	P110



30 x 120 cm



Artikelnummer · Article number	2793
Warengruppe · Product group	Grundfliese · Basic tile
Werksmaße · Dimensions (mm)	298 x 1200 x 9 mm
Farbe · Colour	crema
Oberfläche · Finish	matt Ruhige Eichenholzstruktur reliefiert · matt Calming oak wood structure relief VilbostonePlus
Erzeugnisgruppe	Feinsteinzeug
Material	Porcelain stoneware
Maßeinheit · Unit of measure	m ² 22,22 kg 2,78 pce
Pro Paket · Per box	1,44 m ² 32 kg 4 pce
Pro Palette · Per pallet	51,84 m ² 1152 kg 36 box
Mindestabgabereinheit · Min. sales unit	P (box)
Berechnungseinheit · Calculation unit	m ²
Preisgruppe · Price group	P110

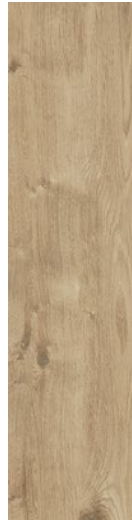

30 x 120 cm



Artikelnummer · Article number	2793
Warengruppe · Product group	Grundfliese · Basic tile
Werksmaße · Dimensions (mm)	298 x 1200 x 9 mm
Farbe · Colour	chalete
Oberfläche · Finish	matt Ruhige Eichenholzstruktur reliefiert · matt Calming oak wood structure relief VilbostonePlus
Erzeugnisgruppe	Feinsteinzeug
Material	Porcelain stoneware
Maßeinheit · Unit of measure	m ² 22,22 kg 2,78 pce
Pro Paket · Per box	1,44 m ² 32 kg 4 pce
Pro Palette · Per pallet	51,84 m ² 1152 kg 36 box
Mindestabgabereinheit · Min. sales unit	P (box)
Berechnungseinheit · Calculation unit	m ²
Preisgruppe · Price group	P110



30 x 120 cm



Artikelnummer · Article number	2793
Warengruppe · Product group	Grundfliese · Basic tile
Werksmaße · Dimensions (mm)	298 x 1200 x 9 mm
Farbe · Colour	brandy
Oberfläche · Finish	matt Ruhige Eichenholzstruktur reliefiert · matt Calming oak wood structure relief VilbostonePlus
Erzeugnisgruppe	Feinsteinzeug
Material	Porcelain stoneware
Maßeinheit · Unit of measure	m ² 22,22 kg 2,78 pce
Pro Paket · Per box	1,44 m ² 32 kg 4 pce
Pro Palette · Per pallet	51,84 m ² 1152 kg 36 box
Mindestabgabereinheit · Min. sales unit	P (box)
Berechnungseinheit · Calculation unit	m ²
Preisgruppe · Price group	P110

Auch im Vilbogarden-Sortiment in 20 mm Dicke
Also in 20-mm thicknesses in the Vilbogarden range

Auch im Vilbogarden-Sortiment in 20 mm Dicke
Also in 20-mm thicknesses in the Vilbogarden range

OAK PARK Wohnen Basis · Living Basis

	30 x 120 cm	20 x 120 cm	20 x 120 cm
Artikelnummer · Article number	2793	2792	2792
Warengruppe · Product group	HR80	HR00	HR10
Werkmaße · Dimensions (mm)	Grundfliese · Basic tile	Grundfliese · Basic tile	Grundfliese · Basic tile
Farbe · Colour	298 x 1200 x 9 mm	197 x 1200 x 9 mm	197 x 1200 x 9 mm
Oberfläche · Finish	cacao	farina	crema
Erzeugnisgruppe	matt Ruhige Eichenholzstruktur reliefiert · matt Calming oak wood structure relief VilbostonePlus	matt Ruhige Eichenholzstruktur reliefiert · matt Calming oak wood structure relief VilbostonePlus	matt Ruhige Eichenholzstruktur reliefiert · matt Calming oak wood structure relief VilbostonePlus
Material	Feinsteinzeug	Feinsteinzeug	Feinsteinzeug
Maßeinheit · Unit of measure	Porcelain stoneware	Porcelain stoneware	Porcelain stoneware
Pro Paket · Per box	m ² 22,22 kg 2,78 pce	m ² 22,50 kg 4,17 pce	m ² 22,50 kg 4,17 pce
Pro Palette · Per pallet	1,44 m ² 32 kg 4 pce	1,20 m ² 24 kg 5 pce	1,20 m ² 24 kg 5 pce
Mindestabgabereinheit · Min. sales unit	51,84 m ² 1152 kg 36 box	54 m ² 1080 kg 45 box	54 m ² 1080 kg 45 box
Berechnungseinheit · Calculation unit	P (box)	P (box)	P (box)
Preisgruppe · Price group	m ²	m ²	m ²
	P110	P110	P110
	20 x 120 cm	20 x 120 cm	20 x 120 cm
Artikelnummer · Article number	2792	2792	2792
Warengruppe · Product group	HR20	HR30	HR80
Werkmaße · Dimensions (mm)	Grundfliese · Basic tile	Grundfliese · Basic tile	Grundfliese · Basic tile
Farbe · Colour	197 x 1200 x 9 mm	197 x 1200 x 9 mm	197 x 1200 x 9 mm
Oberfläche · Finish	chalet	brandy	cacao
Erzeugnisgruppe	matt Ruhige Eichenholzstruktur reliefiert · matt Calming oak wood structure relief VilbostonePlus	matt Ruhige Eichenholzstruktur reliefiert · matt Calming oak wood structure relief VilbostonePlus	matt Ruhige Eichenholzstruktur reliefiert · matt Calming oak wood structure relief VilbostonePlus
Material	Feinsteinzeug	Feinsteinzeug	Feinsteinzeug
Maßeinheit · Unit of measure	Porcelain stoneware	Porcelain stoneware	Porcelain stoneware
Pro Paket · Per box	m ² 22,50 kg 4,17 pce	m ² 22,50 kg 4,17 pce	m ² 22,50 kg 4,17 pce
Pro Palette · Per pallet	1,20 m ² 24 kg 5 pce	1,20 m ² 24 kg 5 pce	1,20 m ² 24 kg 5 pce
Mindestabgabereinheit · Min. sales unit	54 m ² 1080 kg 45 box	54 m ² 1080 kg 45 box	54 m ² 1080 kg 45 box
Berechnungseinheit · Calculation unit	P (box)	P (box)	P (box)
Preisgruppe · Price group	m ²	m ²	m ²
	P110	P110	P110

OAK PARK Wohnen Basis · Living Basis

2,5 x 15 cm 0,09 m ² 298 x 298 mm	2,5 x 15 cm 0,09 m ² 298 x 298 mm	2,5 x 15 cm 0,09 m ² 298 x 298 mm	2,5 x 15 cm 0,09 m ² 298 x 298 mm
2135 HR00	2135 HR10	2135 HR20	2135 HR30
Grundfliese · Basic tile	Grundfliese · Basic tile	Grundfliese · Basic tile	Grundfliese · Basic tile
Werkmaße · Dimensions (mm) 23 x 148 x 11 mm	Werkmaße · Dimensions (mm) 23 x 148 x 11 mm	Werkmaße · Dimensions (mm) 23 x 148 x 11 mm	Werkmaße · Dimensions (mm) 23 x 148 x 11 mm
Farbe · Colour farina	Farbe · Colour crema	Farbe · Colour chalet	Farbe · Colour brandy
Oberfläche · Finish matt Ruhige Eichenholzstruktur reliefiert · matt Calming oak wood structure relief VilbostonePlus	Oberfläche · Finish matt Ruhige Eichenholzstruktur reliefiert · matt Calming oak wood structure relief VilbostonePlus	Oberfläche · Finish matt Ruhige Eichenholzstruktur reliefiert · matt Calming oak wood structure relief VilbostonePlus	Oberfläche · Finish matt Ruhige Eichenholzstruktur reliefiert · matt Calming oak wood structure relief VilbostonePlus
Erzeugnisgruppe Feinsteinzeug	Erzeugnisgruppe Feinsteinzeug	Erzeugnisgruppe Feinsteinzeug	Erzeugnisgruppe Feinsteinzeug
Material Porcelain stoneware	Material Porcelain stoneware	Material Porcelain stoneware	Material Porcelain stoneware
Maßeinheit · Unit of measure m ² 22 kg 11 pce	Maßeinheit · Unit of measure m ² 22 kg 11 pce	Maßeinheit · Unit of measure m ² 22 kg 11 pce	Maßeinheit · Unit of measure m ² 22 kg 11 pce
Pro Paket · Per box 1 m ² 22 kg 11 pce	Pro Paket · Per box 1 m ² 22 kg 11 pce	Pro Paket · Per box 1 m ² 22 kg 11 pce	Pro Paket · Per box 1 m ² 22 kg 11 pce
Pro Palette · Per pallet 36 m ² 792 kg 36 box	Pro Palette · Per pallet 36 m ² 792 kg 36 box	Pro Palette · Per pallet 36 m ² 792 kg 36 box	Pro Palette · Per pallet 36 m ² 792 kg 36 box
Mindestabgabeneinheit · Min. sales unit P (box)	Mindestabgabeneinheit · Min. sales unit P (box)	Mindestabgabeneinheit · Min. sales unit P (box)	Mindestabgabeneinheit · Min. sales unit P (box)
Berechnungseinheit · Calculation unit m ²	Berechnungseinheit · Calculation unit m ²	Berechnungseinheit · Calculation unit m ²	Berechnungseinheit · Calculation unit m ²
Preisgruppe · Price group P179	Preisgruppe · Price group P179	Preisgruppe · Price group P179	Preisgruppe · Price group P179
2,5 x 15 cm 0,09 m ² 298 x 298 mm	7,5 x 7,5 cm 0,09 m ² 297 x 297 mm	7,5 x 7,5 cm 0,09 m ² 297 x 297 mm	
2135 HR80	2013 HR00	2013 HR10	
Grundfliese · Basic tile	Grundfliese · Basic tile	Grundfliese · Basic tile	
Werkmaße · Dimensions (mm) 23 x 148 x 11 mm	Werkmaße · Dimensions (mm) 72 x 72 x 11 mm	Werkmaße · Dimensions (mm) 72 x 72 x 11 mm	
Farbe · Colour cacao	Farbe · Colour farina	Farbe · Colour crema	
Oberfläche · Finish matt Ruhige Eichenholzstruktur reliefiert · matt Calming oak wood structure relief VilbostonePlus	Oberfläche · Finish matt Ruhige Eichenholzstruktur reliefiert · matt Calming oak wood structure relief VilbostonePlus	Oberfläche · Finish matt Ruhige Eichenholzstruktur reliefiert · matt Calming oak wood structure relief VilbostonePlus	
Erzeugnisgruppe Feinsteinzeug	Erzeugnisgruppe Feinsteinzeug	Erzeugnisgruppe Feinsteinzeug	
Material Porcelain stoneware	Material Porcelain stoneware	Material Porcelain stoneware	
Maßeinheit · Unit of measure m ² 22 kg 11 pce	Maßeinheit · Unit of measure m ² 20,90 kg 11 pce	Maßeinheit · Unit of measure m ² 20,90 kg 11 pce	
Pro Paket · Per box 1 m ² 22 kg 11 pce	Pro Paket · Per box 1 m ² 20,90 kg 11 pce	Pro Paket · Per box 1 m ² 20,90 kg 11 pce	
Pro Palette · Per pallet 36 m ² 792 kg 36 box	Pro Palette · Per pallet 36 m ² 752,40 kg 36 box	Pro Palette · Per pallet 36 m ² 752,40 kg 36 box	
Mindestabgabeneinheit · Min. sales unit P (box)	Mindestabgabeneinheit · Min. sales unit P (box)	Mindestabgabeneinheit · Min. sales unit P (box)	
Berechnungseinheit · Calculation unit m ²	Berechnungseinheit · Calculation unit m ²	Berechnungseinheit · Calculation unit m ²	
Preisgruppe · Price group P179	Preisgruppe · Price group P159	Preisgruppe · Price group P159	
7,5 x 7,5 cm 0,09 m ² 297 x 297 mm	7,5 x 7,5 cm 0,09 m ² 297 x 297 mm	7,5 x 7,5 cm 0,09 m ² 297 x 297 mm	
2013 HR20	2013 HR30	2013 HR80	
Grundfliese · Basic tile	Grundfliese · Basic tile	Grundfliese · Basic tile	
Werkmaße · Dimensions (mm) 72 x 72 x 11 mm	Werkmaße · Dimensions (mm) 72 x 72 x 11 mm	Werkmaße · Dimensions (mm) 72 x 72 x 11 mm	
Farbe · Colour chalet	Farbe · Colour brandy	Farbe · Colour cacao	
Oberfläche · Finish matt Ruhige Eichenholzstruktur reliefiert · matt Calming oak wood structure relief VilbostonePlus	Oberfläche · Finish matt Ruhige Eichenholzstruktur reliefiert · matt Calming oak wood structure relief VilbostonePlus	Oberfläche · Finish matt Ruhige Eichenholzstruktur reliefiert · matt Calming oak wood structure relief VilbostonePlus	
Erzeugnisgruppe Feinsteinzeug	Erzeugnisgruppe Feinsteinzeug	Erzeugnisgruppe Feinsteinzeug	
Material Porcelain stoneware	Material Porcelain stoneware	Material Porcelain stoneware	
Maßeinheit · Unit of measure m ² 20,90 kg 11 pce	Maßeinheit · Unit of measure m ² 20,90 kg 11 pce	Maßeinheit · Unit of measure m ² 20,90 kg 11 pce	
Pro Paket · Per box 1 m ² 20,90 kg 11 pce	Pro Paket · Per box 1 m ² 20,90 kg 11 pce	Pro Paket · Per box 1 m ² 20,90 kg 11 pce	
Pro Palette · Per pallet 36 m ² 752,40 kg 36 box	Pro Palette · Per pallet 36 m ² 752,40 kg 36 box	Pro Palette · Per pallet 36 m ² 752,40 kg 36 box	
Mindestabgabeneinheit · Min. sales unit P (box)	Mindestabgabeneinheit · Min. sales unit P (box)	Mindestabgabeneinheit · Min. sales unit P (box)	
Berechnungseinheit · Calculation unit m ²	Berechnungseinheit · Calculation unit m ²	Berechnungseinheit · Calculation unit m ²	
Preisgruppe · Price group P159	Preisgruppe · Price group P159	Preisgruppe · Price group P159	

OAK PARK Wohnen Basis · Living Basis

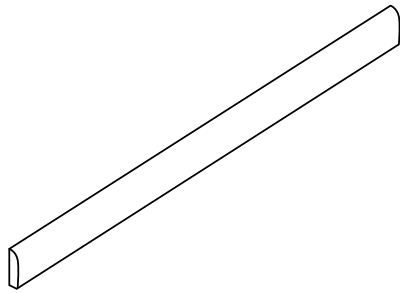

7,5 x 120 cm

Artikelnummer · Article number	2139
Warengruppe · Product group	HR00, HR10, HR20 HR30, HR80
Werksmaße · Dimensions (mm)	Socket · Skirting 72 x 1197 x 9 mm
Farbe · Colour	-
Oberfläche · Finish	matt Ruhige Eichenholzstruktur reliefiert · matt Calming oak wood structure relief VilbostonePlus
Erzeugnisgruppe	Feinsteinzeug
Material	Porcelain stoneware
Maßeinheit · Unit of measure	m 1,6 kg 0,83 pce
Pro Paket · Per box	8,43 m 13,51 kg 7 pce
Pro Palette · Per pallet	472,29 m 756,56 kg 56 box
Mindestabgabereinheit · Min. sales unit	E (pce)
Berechnungseinheit · Calculation unit	Stück · piece
Preisgruppe · Price group	E77

OAK SIDE Wohnen · Living

Concept³



30 x 90 cm



30 x 90 cm



30 x 120 cm



30 x 120 cm



Artikelnummer · Article number	1323	1323	2793	2793
Warengruppe · Product group	HE00	HE10	HE10	HE20
Werksmaße · Dimensions (mm)	Grundfliese · Basic tile 297 x 897 x 10 mm	Grundfliese · Basic tile 297 x 897 x 10 mm	Grundfliese · Basic tile 298 x 1200 x 9 mm	Grundfliese · Basic tile 298 x 1200 x 9 mm
Farbe · Colour	white	creme	avena	terra
Oberfläche · Finish	matt reliefiert · matt relief CeramicPlus	matt reliefiert · matt relief CeramicPlus	vilbotouch matt Belebte Eichenholzstruktur reliefiert · vilbotouch matt Fresh oak wood structure relief VilbostonePlus	vilbotouch matt Belebte Eichenholzstruktur reliefiert · vilbotouch matt Fresh oak wood structure relief VilbostonePlus
Erzeugnisgruppe	Steingut	Steingut	Feinsteinzeug	Feinsteinzeug
Material	Nonvitreous	Nonvitreous	Porcelain stoneware	Porcelain stoneware
Maßeinheit · Unit of measure	m ² 17,15 kg 3,70 pce	m ² 17,15 kg 3,70 pce	m ² 22,22 kg 2,78 pce	m ² 22,22 kg 2,78 pce
Pro Paket · Per box	1,35 m ² 23,15 kg 5 pce	1,35 m ² 23,15 kg 5 pce	1,44 m ² 32 kg 4 pce	1,44 m ² 32 kg 4 pce
Pro Palette · Per pallet	32,40 m ² 555,60 kg 24 box	32,40 m ² 555,60 kg 24 box	51,84 m ² 1152 kg 36 box	51,84 m ² 1152 kg 36 box
Mindestabgabereinheit · Min. sales unit	P (box)	P (box)	P (box)	P (box)
Berechnungseinheit · Calculation unit	m ²	m ²	m ²	m ²
Preisgruppe · Price group	P105	P105	P120	P120

OAK SIDE Wohnen · Living

Concept³

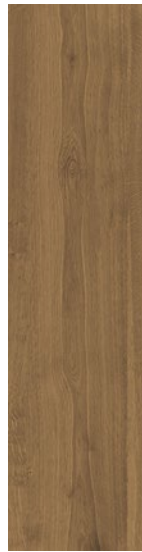

30 x 120 cm



30 x 120 cm



20 x 120 cm



20 x 120 cm



Artikelnummer · Article number	2793	2793	2792	2792
Warengruppe · Product group	HE30	HE80	HE10	HE20
Werkmaße · Dimensions (mm)	298 x 1200 x 9 mm	298 x 1200 x 9 mm	197 x 1200 x 9 mm	197 x 1200 x 9 mm
Farbe · Colour	cognac	chocolate	avena	terra
Oberfläche · Finish	vilbotouch matt Belebte Eichenholzstruktur reliefiert · vilbotouch matt Fresh oak wood structure relief	vilbotouch matt Belebte Eichenholzstruktur reliefiert · vilbotouch matt Fresh oak wood structure relief	vilbotouch matt Belebte Eichenholzstruktur reliefiert · vilbotouch matt Fresh oak wood structure relief	vilbotouch matt Belebte Eichenholzstruktur reliefiert · vilbotouch matt Fresh oak wood structure relief
Erzeugnisgruppe	VilbostonePlus	VilbostonePlus	VilbostonePlus	VilbostonePlus
Material	Feinsteinzeug	Feinsteinzeug	Feinsteinzeug	Feinsteinzeug
Maßeinheit · Unit of measure	Porcelain stoneware	Porcelain stoneware	Porcelain stoneware	Porcelain stoneware
Pro Paket · Per box	m ² 22,22 kg 2,78 pce	m ² 22,22 kg 2,78 pce	m ² 20 kg 4,17 pce	m ² 20 kg 4,17 pce
Pro Palette · Per pallet	1,44 m ² 32 kg 4 pce	1,44 m ² 32 kg 4 pce	1,20 m ² 24 kg 5 pce	1,20 m ² 24 kg 5 pce
Mindestabgabeneinheit · Min. sales unit	51,84 m ² 1152 kg 36 box	51,84 m ² 1152 kg 36 box	54 m ² 1080 kg 45 box	54 m ² 1080 kg 45 box
Berechnungseinheit · Calculation unit	P (box)	P (box)	P (box)	P (box)
Preisgruppe · Price group	m ²	m ²	m ²	m ²
	P120	P120	P120	P120

OAK SIDE Wohnen · Living

Concept³



20 x 120 cm



5 x 5 cm

□ 0,09 m² | 298 x 298 mm

Artikelnummer · Article number	2792	2030
Warengruppe · Product group	HE30	HE99
Werkmaße · Dimensions (mm)	Grundfliese · Basic tile 197 x 1200 x 9 mm	Dekor · Decor 48 x 48 x 9 mm
Farbe · Colour	cognac	multicolor
Oberfläche · Finish	vilbotouch matt Belebte Eichenholzstruktur reliefiert · vilbotouch matt Fresh oak wood structure relief VilbostonePlus	vilbotouch matt Belebte Eichenholzstruktur reliefiert · vilbotouch matt Fresh oak wood structure relief
Erzeugnisgruppe	Feinsteinzeug	Feinsteinzeug
Material	Porcelain stoneware	Porcelain stoneware
Maßeinheit · Unit of measure	m ² 20 kg 4,17 pce	m ² 23,10 kg 11 pce
Pro Paket · Per box	1,20 m ² 24 kg 5 pce	1 m ² 23,10 kg 11 pce
Pro Palette · Per pallet	54 m ² 1080 kg 45 box	36 m ² 831,60 kg 36 box
Mindestabgabereinheit · Min. sales unit	P (box)	P (box)
Berechnungseinheit · Calculation unit	m ²	m ²
Preisgruppe · Price group	P120	P192

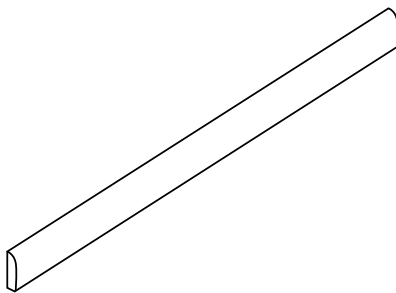

7,5 x 120 cm

Artikelnummer · Article number	2139
Warengruppe · Product group	HE10, HE20, HE30 HE80
Werkmaße · Dimensions (mm)	Sockel · Skirting 72 x 1197 x 9 mm
Farbe · Colour	-
Oberfläche · Finish	vilbotouch matt Belebte Eichenholzstruktur reliefiert · vilbotouch matt Fresh oak wood structure relief VilbostonePlus
Erzeugnisgruppe	Feinsteinzeug
Material	Porcelain stoneware
Maßeinheit · Unit of measure	m 1,6 kg 0,83 pce
Pro Paket · Per box	8,43 m 13,51 kg 7 pce
Pro Palette · Per pallet	472,29 m 756,56 kg 56 box
Mindestabgabereinheit · Min. sales unit	E (pce)
Berechnungseinheit · Calculation unit	Stück · piece
Preisgruppe · Price group	E76

OMBRA *Excellence* by Villeroy & Boch

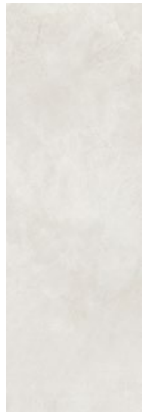

30 x 90 cm



30 x 90 cm

Artikelnummer · Article number	1310 IA01	1310 IA12
Warengruppe · Product group	Grundfliese · Basic tile	Dekor · Decor
Werkmaße · Dimensions (mm)	297 x 897 x 9 mm	297 x 897 x 10 mm
Farbe · Colour	white	white
Oberfläche · Finish	matt Betonstruktur · matt concrete texture CeramicPlus	matt Betonstruktur reliefiert · matt concrete texture relief CeramicPlus
Erzeugnisgruppe	Steingut	Steingut
Material	Nonvitreous	Nonvitreous
Maßeinheit · Unit of measure	m ² 16,85 kg 3,70 pce	m ² 16,85 kg 3,70 pce
Pro Paket · Per box	1,35 m ² 22,75 kg 5 pce	1,08 m ² 18,20 kg 4 pce
Pro Palette · Per pallet	32,4 m ² 546 kg 27 box	25,92 m ² 436,80 kg 24 box
Mindestabgabereinheit · Min. sales unit	P (box)	P (box)
Berechnungseinheit · Calculation unit	m ²	m ²
Preisgruppe · Price group	P105	P121

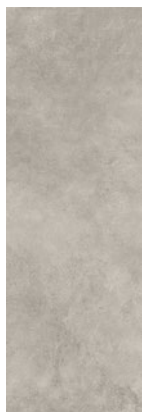

30 x 90 cm



30 x 90 cm



30 x 90 cm



1 x 90 cm

Artikelnummer · Article number	1310 IA03	1310 IA31	1310 IA32	1070 IA00
Warengruppe · Product group	Grundfliese · Basic tile	Dekor · Decor	Dekor · Decor	Bordüre · Border
Werkmaße · Dimensions (mm)	297 x 897 x 10 mm	297 x 897 x 9 mm	297 x 897 x 10 mm	10 x 897 x 10 mm
Farbe · Colour	grey	grey	grey	silver
Oberfläche · Finish	matt Betonstruktur · matt concrete texture CeramicPlus	matt Betonstruktur reliefiert · matt concrete texture relief CeramicPlus	matt Betonstruktur reliefiert · matt concrete texture relief CeramicPlus	semi-glanz · silky sheen
Erzeugnisgruppe	Steingut	Steingut	Steingut	Metall
Material	Nonvitreous	Nonvitreous	Nonvitreous	metal
Maßeinheit · Unit of measure	m ² 16,85 kg 3,70 pce	m ² 16,85 kg 3,70 pce	m ² 16,85 kg 3,70 pce	m 1,20 kg 1,11 pce
Pro Paket · Per box	1,35 m ² 22,75 kg 5 pce	1,08 m ² 18,20 kg 4 pce	1,08 m ² 18,20 kg 4 pce	7,2 m ² 8,64 kg 8 pce
Pro Palette · Per pallet	32,4 m ² 546 kg 27 box	25,92 m ² 436,80 kg 24 box	25,92 m ² 436,80 kg 24 box	-
Mindestabgabereinheit · Min. sales unit	P (box)	P (box)	P (box)	E (pce)
Berechnungseinheit · Calculation unit	m ²	m ²	m ²	Stück · piece
Preisgruppe · Price group	P105	P121	P121	E85

PIER 45 Wohnen · Living

	60 x 120 cm	60 x 120 cm	60 x 120 cm	60 x 60 cm
Artikelnummer · Article number	2736	2736	2736	2632
Warengruppe · Product group	BR60	BR80	BR90	BR60
Werksmaße · Dimensions (mm)	Grundfliese · Basic tile 597 x 1197 x 9 mm	Grundfliese · Basic tile 597 x 1197 x 9 mm	Grundfliese · Basic tile 597 x 1197 x 9 mm	Grundfliese · Basic tile 597 x 597 x 9 mm
Farbe · Colour	ash grey	rusty grey	smokey black	ash grey
Oberfläche · Finish	matt Belebte Betonoptik reliefiert · matt Fresh concrete look relief	matt Belebte Betonoptik reliefiert · matt Fresh concrete look relief	matt Belebte Betonoptik reliefiert · matt Fresh concrete look relief	matt Belebte Betonoptik reliefiert · matt Fresh concrete look relief
Erzeugnisgruppe	VilbostonePlus	VilbostonePlus	VilbostonePlus	VilbostonePlus
Material	Feinsteinzeug	Feinsteinzeug	Feinsteinzeug	Feinsteinzeug
Maßeinheit · Unit of measure	Porcelain stoneware	Porcelain stoneware	Porcelain stoneware	Porcelain stoneware
Pro Paket · Per box	m ² 19,49 kg 1,39 pce	m ² 19,49 kg 1,39 pce	m ² 19,49 kg 1,39 pce	m ² 19,72 kg 2,78 pce
Pro Palette · Per pallet	1,44 m ² 28,06 kg 2 pce	1,44 m ² 28,06 kg 2 pce	1,44 m ² 28,06 kg 2 pce	1,44 m ² 28,40 kg 4 pce
Mindestabgabereinheit · Min. sales unit	43,2 m ² 841,8 kg 30 box	43,2 m ² 841,8 kg 30 box	43,2 m ² 841,8 kg 30 box	43,20 m ² 852 kg 30 box
Berechnungseinheit · Calculation unit	P (box)	P (box)	P (box)	P (box)
Preisgruppe · Price group	m ²	m ²	m ²	m ²
	P110	P110	P110	P99
Artikelnummer · Article number	2632	2632	2632	2632
Warengruppe · Product group	BR80	BR90	BR65	BR85
Werksmaße · Dimensions (mm)	Grundfliese · Basic tile 597 x 597 x 9 mm	Grundfliese · Basic tile 597 x 597 x 9 mm	Dekor · Decor 597 x 597 x 9 mm	Dekor · Decor 597 x 597 x 9 mm
Farbe · Colour	rusty grey	smokey black	ash grey	rusty grey
Oberfläche · Finish	matt Belebte Betonoptik reliefiert · matt Fresh concrete look relief	matt Belebte Betonoptik reliefiert · matt Fresh concrete look relief	matt Belebte Betonoptik reliefiert · matt Fresh concrete look relief	matt Belebte Betonoptik reliefiert · matt Fresh concrete look relief
Erzeugnisgruppe	VilbostonePlus	VilbostonePlus	VilbostonePlus	VilbostonePlus
Material	Feinsteinzeug	Feinsteinzeug	Feinsteinzeug glasiert	Feinsteinzeug glasiert
Maßeinheit · Unit of measure	Porcelain stoneware	Porcelain stoneware	Glazed porcelain stoneware	Glazed porcelain stoneware
Pro Paket · Per box	m ² 19,72 kg 2,78 pce	m ² 19,72 kg 2,78 pce	m ² 19,72 kg 2,78 pce	m ² 19,72 kg 2,78 pce
Pro Palette · Per pallet	1,44 m ² 28,40 kg 4 pce	1,44 m ² 28,40 kg 4 pce	1,44 m ² 28,40 kg 4 pce	1,44 m ² 28,40 kg 4 pce
Mindestabgabereinheit · Min. sales unit	43,20 m ² 852 kg 30 box	43,20 m ² 852 kg 30 box	43,20 m ² 852 kg 30 box	43,20 m ² 852 kg 30 box
Berechnungseinheit · Calculation unit	P (box)	P (box)	P (box)	P (box)
Preisgruppe · Price group	m ²	m ²	m ²	m ²
	P99	P99	P123	P123



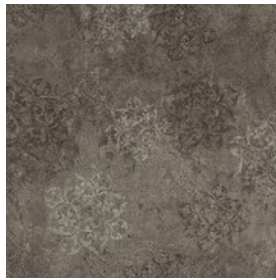



PIER 45 Wohnen · Living



60 x 60 cm 



80 x 80 cm 







Artikelnummer · Article number	2632	2834
Warengruppe · Product group	BR95   	BR60   
Werkmaße · Dimensions (mm)	597 x 597 x 9 mm	797 x 797 x 9 mm
Farbe · Colour	smokey black	ash grey
Oberfläche · Finish	matt Belebte Betonoptik reliefiert · matt Fresh concrete look relief	matt Belebte Betonoptik reliefiert · matt Fresh concrete look relief VilbostonePlus
Erzeugnisgruppe	Feinsteinzeug glasiert	Feinsteinzeug
Material	Glazed porcelain stoneware	Porcelain stoneware
Maßeinheit · Unit of measure	m ² 19,72 kg 2,78 pce	m ² 19,06 kg 1,56 pce
Pro Paket · Per box	1,44 m ² 28,40 kg 4 pce	1,28 m ² 24,40 kg 2 pce
Pro Palette · Per pallet	43,20 m ² 852 kg 30 box	51,20 m ² 976 kg 40 box
Mindestabgabereinheit · Min. sales unit	P (box)	P (box)
Berechnungseinheit · Calculation unit	m ²	m ²
Preisgruppe · Price group	P123	P110



80 x 80 cm 



80 x 80 cm 

Artikelnummer · Article number	2834	2834
Warengruppe · Product group	BR80   	BR90   
Werkmaße · Dimensions (mm)	797 x 797 x 9 mm	797 x 797 x 9 mm
Farbe · Colour	rusty grey	smokey black
Oberfläche · Finish	matt Belebte Betonoptik reliefiert · matt Fresh concrete look relief VilbostonePlus	matt Belebte Betonoptik reliefiert · matt Fresh concrete look relief VilbostonePlus
Erzeugnisgruppe	Feinsteinzeug	Feinsteinzeug
Material	Porcelain stoneware	Porcelain stoneware
Maßeinheit · Unit of measure	m ² 19,06 kg 1,56 pce	m ² 19,06 kg 1,56 pce
Pro Paket · Per box	1,28 m ² 24,40 kg 2 pce	1,28 m ² 24,40 kg 2 pce
Pro Palette · Per pallet	51,20 m ² 976 kg 40 box	51,20 m ² 976 kg 40 box
Mindestabgabereinheit · Min. sales unit	P (box)	P (box)
Berechnungseinheit · Calculation unit	m ²	m ²
Preisgruppe · Price group	P110	P110

PIER 45 Wohnen · Living



80 x 80 cm



80 x 80 cm



Artikelnummer · Article number	2834
Warengruppe · Product group	BR65
Werksmaße · Dimensions (mm)	797 x 797 x 9 mm
Farbe · Colour	ash grey
Oberfläche · Finish	matt Belebte Betonoptik reliefiert · matt Fresh concrete look relief
Erzeugnisgruppe	Feinsteinzeug glasiert
Material	Glazed porcelain stoneware
Maßeinheit · Unit of measure	m ² 19,06 kg 1,56 pce
Pro Paket · Per box	1,28 m ² 24,40 kg 2 pce
Pro Palette · Per pallet	51,20 m ² 976 kg 40 box
Mindestabgabereinheit · Min. sales unit	P (box)
Berechnungseinheit · Calculation unit	m ²
Preisgruppe · Price group	P134

Artikelnummer · Article number	2834
Warengruppe · Product group	BR85
Werksmaße · Dimensions (mm)	797 x 797 x 9 mm
Farbe · Colour	rusty grey
Oberfläche · Finish	matt Belebte Betonoptik reliefiert · matt Fresh concrete look relief
Erzeugnisgruppe	Feinsteinzeug glasiert
Material	Glazed porcelain stoneware
Maßeinheit · Unit of measure	m ² 19,06 kg 1,56 pce
Pro Paket · Per box	1,28 m ² 24,40 kg 2 pce
Pro Palette · Per pallet	51,20 m ² 976 kg 40 box
Mindestabgabereinheit · Min. sales unit	P (box)
Berechnungseinheit · Calculation unit	m ²
Preisgruppe · Price group	P134



80 x 80 cm











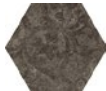

13 x 15 cm

Artikelnummer · Article number	2834
Warengruppe · Product group	BR95
Werksmaße · Dimensions (mm)	797 x 797 x 9 mm
Farbe · Colour	smokey black
Oberfläche · Finish	matt Belebte Betonoptik reliefiert · matt Fresh concrete look relief
Erzeugnisgruppe	Feinsteinzeug glasiert
Material	Glazed porcelain stoneware
Maßeinheit · Unit of measure	m ² 19,06 kg 1,56 pce
Pro Paket · Per box	1,28 m ² 24,40 kg 2 pce
Pro Palette · Per pallet	51,20 m ² 976 kg 40 box
Mindestabgabereinheit · Min. sales unit	P (box)
Berechnungseinheit · Calculation unit	m ²
Preisgruppe · Price group	P134

Artikelnummer · Article number	2016
Warengruppe · Product group	BR65
Werksmaße · Dimensions (mm)	127,30 x 147 x 9 mm
Farbe · Colour	ash grey
Oberfläche · Finish	matt Belebte Betonoptik reliefiert · matt Fresh concrete look relief
Erzeugnisgruppe	Feinsteinzeug glasiert
Material	Glazed porcelain stoneware
Maßeinheit · Unit of measure	m ² 17,81 kg 68,49 pce
Pro Paket · Per box	0,47 m ² 8,32 kg 32 pce
Pro Palette · Per pallet	31,77 m ² 565,76 kg 68 box
Mindestabgabereinheit · Min. sales unit	P (box)
Berechnungseinheit · Calculation unit	m ²
Preisgruppe · Price group	P154

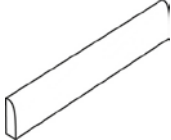
PIER 45 Wohnen · Living

	 13 x 15 cm	 13 x 15 cm	 5 x 5 cm □ 0,09 m ² 297 x 297 mm	 5 x 5 cm □ 0,09 m ² 297 x 297 mm
Artikelnummer · Article number	2016 BR85 	2016 BR95 	2030 BR60 	2030 BR80 
Warengruppe · Product group	Dekor · Decor	Dekor · Decor	Grundfliese · Basic tile	Grundfliese · Basic tile
Werkmaße · Dimensions (mm)	127,30 x 147 x 9 mm	127,30 x 147 x 9 mm	47 x 47 x 9 mm	47 x 47 x 9 mm
Farbe · Colour	rusty grey	smokey black	ash grey	rusty grey
Oberfläche · Finish	matt Belebte Betonoptik reliefiert · matt Fresh concrete look relief	matt Belebte Betonoptik reliefiert · matt Fresh concrete look relief	matt Belebte Betonoptik reliefiert · matt Fresh concrete look relief	matt Belebte Betonoptik reliefiert · matt Fresh concrete look relief
Erzeugnisgruppe	Feinsteinzeug glasiert	Feinsteinzeug glasiert	Feinsteinzeug	Feinsteinzeug
Material	Glazed porcelain stoneware	Glazed porcelain stoneware	Porcelain stoneware	Porcelain stoneware
Maßeinheit · Unit of measure	m ² 17,81 kg 68,49 pce	m ² 17,81 kg 68,49 pce	m ² 20,90 kg 11 pce	m ² 20,90 kg 11 pce
Pro Paket · Per box	0,47 m ² 8,32 kg 32 pce	0,47 m ² 8,32 kg 32 pce	1,09 m ² 22,80 kg 12 pce	1,09 m ² 22,80 kg 12 pce
Pro Palette · Per pallet	31,77 m ² 565,76 kg 68 box	31,77 m ² 565,76 kg 68 box	39,27 m ² 820,80 kg 36 box	39,27 m ² 820,80 kg 36 box
Mindestabgabeneinheit · Min. sales unit	P (box)	P (box)	P (box)	P (box)
Berechnungseinheit · Calculation unit	m ²	m ²	m ²	m ²
Preisgruppe · Price group	P154	P154	P187	P187
	 5 x 5 cm □ 0,09 m ² 297 x 297 mm	 5 x 60 cm		
Artikelnummer · Article number	2030 BR90 	2875 BR60, BR80, BR90 		
Warengruppe · Product group	Grundfliese · Basic tile	Sockel · Skirting		
Werkmaße · Dimensions (mm)	47 x 47 x 9 mm	48 x 597 x 9 mm		
Farbe · Colour	smokey black	-		
Oberfläche · Finish	matt Belebte Betonoptik reliefiert · matt Fresh concrete look relief	matt Belebte Betonoptik reliefiert · matt Fresh concrete look relief		
Erzeugnisgruppe	Feinsteinzeug	Feinsteinzeug		
Material	Porcelain stoneware	Porcelain stoneware		
Maßeinheit · Unit of measure	m ² 20,90 kg 11 pce	m 1,05 kg 1,66 pce		
Pro Paket · Per box	1,09 m ² 22,80 kg 12 pce	9,04 m 9,45 kg 15 pce		
Pro Palette · Per pallet	39,27 m ² 820,80 kg 36 box	433,74 m 453,60 kg 48 box		
Mindestabgabeneinheit · Min. sales unit	P (box)	E (pce)		
Berechnungseinheit · Calculation unit	m ²	Stück · piece		
Preisgruppe · Price group	P187	E60		

PURE BASE Wohnen Basis · Living Basis

Concept³

	30 x 60 cm	30 x 60 cm	80 x 80 cm
	1	1	2
Artikelnummer · Article number	1571	1571	2835
Warengruppe · Product group	BT21	BT01	BZ10
Werksmaße · Dimensions (mm)	Grundfliese · Basic tile 297 x 597 x 9 mm	Grundfliese · Basic tile 297 x 597 x 9 mm	Grundfliese · Basic tile 797 x 797 x 9 mm
Farbe · Colour	creme	light grey	creme
Oberfläche · Finish	matt Betonstruktur · matt concrete texture CeramicPlus	matt Betonstruktur · matt concrete texture CeramicPlus	VilboTouch matt Betonstruktur reliefiert · VilboTouch matt concrete texture relief VilbostonePlus
Erzeugnisgruppe	Steingut	Steingut	Feinsteinzeug
Material	Nonvitreous	Nonvitreous	Porcelain stoneware
Maßeinheit · Unit of measure	m ² 15,56 kg 5,56 pce	m ² 15,56 kg 5,56 pce	m ² 19,06 kg 1,56 pce
Pro Paket · Per box	1,08 m ² 16,80 kg 6 pce	1,08 m ² 16,80 kg 6 pce	1,28 m ² 24,40 kg 2 pce
Pro Palette · Per pallet	51,84 m ² 806,40 kg 48 box	51,84 m ² 806,40 kg 48 box	51,20 m ² 976 kg 40 box
Mindestabgabereinheit · Min. sales unit	P (box)	P (box)	P (box)
Berechnungseinheit · Calculation unit	m ²	m ²	m ²
Preisgruppe · Price group	P71	P71	P93
	80 x 80 cm		80 x 80 cm
		2	2
Artikelnummer · Article number	2835		2835
Warengruppe · Product group	BZ70		BZ06
Werksmaße · Dimensions (mm)	Grundfliese · Basic tile 797 x 797 x 9 mm		Grundfliese · Basic tile 797 x 797 x 9 mm
Farbe · Colour	sand grey		silver grey
Oberfläche · Finish	VilboTouch matt Betonstruktur reliefiert · VilboTouch matt concrete texture relief VilbostonePlus		VilboTouch matt Betonstruktur reliefiert · VilboTouch matt concrete texture relief VilbostonePlus
Erzeugnisgruppe	Feinsteinzeug		Feinsteinzeug
Material	Porcelain stoneware		Porcelain stoneware
Maßeinheit · Unit of measure	m ² 19,06 kg 1,56 pce		m ² 19,06 kg 1,56 pce
Pro Paket · Per box	1,28 m ² 24,40 kg 2 pce		1,28 m ² 24,40 kg 2 pce
Pro Palette · Per pallet	51,20 m ² 976 kg 40 box		51,20 m ² 976 kg 40 box
Mindestabgabereinheit · Min. sales unit	P (box)		P (box)
Berechnungseinheit · Calculation unit	m ²		m ²
Preisgruppe · Price group	P93		P93

PURE BASE Wohnen Basis · Living Basis

Concept³



80 x 80 cm

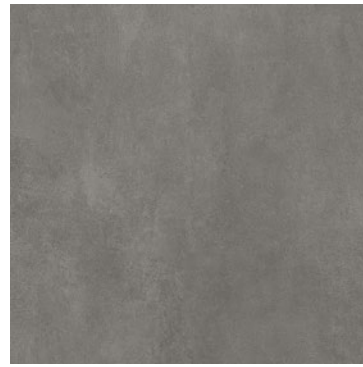

80 x 80 cm



Artikelnummer · Article number	2835
	BZ40
Warengruppe · Product group	Grundfliese · Basic tile
Werksmaße · Dimensions (mm)	797 x 797 x 9 mm
Farbe · Colour	medium grey
Oberfläche · Finish	VilboTouch matt Betonstruktur reliefiert · VilboTouch matt concrete texture relief VilbostonePlus
Erzeugnisgruppe	Feinsteinzeug
Material	Porcelain stoneware
Maßeinheit · Unit of measure	m ² 19,06 kg 1,56 pce
Pro Paket · Per box	1,28 m ² 24,40 kg 2 pce
Pro Palette · Per pallet	51,20 m ² 976 kg 40 box
Mindestabgabeneinheit · Min. sales unit	P (box)
Berechnungseinheit · Calculation unit	m ²
Preisgruppe · Price group	P93

Artikelnummer · Article number	2835
	BZ60
Warengruppe · Product group	Grundfliese · Basic tile
Werksmaße · Dimensions (mm)	797 x 797 x 9 mm
Farbe · Colour	grey
Oberfläche · Finish	VilboTouch matt Betonstruktur reliefiert · VilboTouch matt concrete texture relief VilbostonePlus
Erzeugnisgruppe	Feinsteinzeug
Material	Porcelain stoneware
Maßeinheit · Unit of measure	m ² 19,06 kg 1,56 pce
Pro Paket · Per box	1,28 m ² 24,40 kg 2 pce
Pro Palette · Per pallet	51,20 m ² 976 kg 40 box
Mindestabgabeneinheit · Min. sales unit	P (box)
Berechnungseinheit · Calculation unit	m ²
Preisgruppe · Price group	P93



80 x 80 cm



80 x 80 cm



Artikelnummer · Article number	2835
	BZ79
Warengruppe · Product group	Dekor · Decor
Werksmaße · Dimensions (mm)	797 x 797 x 9 mm
Farbe · Colour	multicolor sand
Oberfläche · Finish	VilboTouch matt Betonstruktur reliefiert · VilboTouch matt concrete texture relief
Erzeugnisgruppe	Feinsteinzeug glasiert
Material	Glazed porcelain stoneware
Maßeinheit · Unit of measure	m ² 19,06 kg 1,56 pce
Pro Paket · Per box	1,28 m ² 24,40 kg 2 pce
Pro Palette · Per pallet	51,20 m ² 976 kg 40 box
Mindestabgabeneinheit · Min. sales unit	P (box)
Berechnungseinheit · Calculation unit	m ²
Preisgruppe · Price group	P124

Artikelnummer · Article number	2835
	BZ69
Warengruppe · Product group	Dekor · Decor
Werksmaße · Dimensions (mm)	797 x 797 x 9 mm
Farbe · Colour	multicolor grey
Oberfläche · Finish	VilboTouch matt Betonstruktur reliefiert · VilboTouch matt concrete texture relief
Erzeugnisgruppe	Feinsteinzeug glasiert
Material	Glazed porcelain stoneware
Maßeinheit · Unit of measure	m ² 19,06 kg 1,56 pce
Pro Paket · Per box	1,28 m ² 24,40 kg 2 pce
Pro Palette · Per pallet	51,20 m ² 976 kg 40 box
Mindestabgabeneinheit · Min. sales unit	P (box)
Berechnungseinheit · Calculation unit	m ²
Preisgruppe · Price group	P124













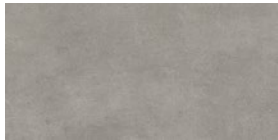



























PURE BASE Wohnen Basis · Living Basis

Concept³



	60 x 60 cm	60 x 60 cm	60 x 60 cm	60 x 60 cm
Artikelnummer · Article number	2361	2361	2361	2361
	BZ10	BZ70	BZ06	BZ40
Warengruppe · Product group	Grundfliese · Basic tile	Grundfliese · Basic tile	Grundfliese · Basic tile	Grundfliese · Basic tile
Werksmaße · Dimensions (mm)	597 x 597 x 9 mm	597 x 597 x 9 mm	597 x 597 x 9 mm	597 x 597 x 9 mm
Farbe · Colour	creme	sand grey	silver grey	medium grey
Oberfläche · Finish	VilboTouch matt Betonstruktur reliefiert · VilboTouch matt concrete texture relief VilbostonePlus	VilboTouch matt Betonstruktur reliefiert · VilboTouch matt concrete texture relief VilbostonePlus	VilboTouch matt Betonstruktur reliefiert · VilboTouch matt concrete texture relief VilbostonePlus	VilboTouch matt Betonstruktur reliefiert · VilboTouch matt concrete texture relief VilbostonePlus
Erzeugnisgruppe	Feinsteinzeug	Feinsteinzeug	Feinsteinzeug	Feinsteinzeug
Material	Porcelain stoneware	Porcelain stoneware	Porcelain stoneware	Porcelain stoneware
Maßeinheit · Unit of measure	m ² 19,72 kg 2,78 pce	m ² 19,72 kg 2,78 pce	m ² 19,72 kg 2,78 pce	m ² 19,72 kg 2,78 pce
Pro Paket · Per box	1,44 m ² 28,40 kg 4 pce	1,44 m ² 28,40 kg 4 pce	1,44 m ² 28,40 kg 4 pce	1,44 m ² 28,40 kg 4 pce
Pro Palette · Per pallet	43,20 m ² 852 kg 30 box	43,20 m ² 852 kg 30 box	43,20 m ² 852 kg 30 box	43,20 m ² 852 kg 30 box
Mindestabgabereinheit · Min. sales unit	P (box)	P (box)	P (box)	P (box)
Berechnungseinheit · Calculation unit	m ²	m ²	m ²	m ²
Preisgruppe · Price group	P74	P74	P74	P74
	60 x 60 cm	60 x 60 cm	60 x 60 cm	45 x 45 cm
Artikelnummer · Article number	2361	2361	2361	2733
	BZ60	BZ79	BZ69	BZ06, BZ10, BZ40 BZ60, BZ70
Warengruppe · Product group	Grundfliese · Basic tile	Dekor · Decor	Dekor · Decor	Grundfliese · Basic tile
Werksmaße · Dimensions (mm)	597 x 597 x 9 mm	597 x 597 x 9 mm	597 x 597 x 9 mm	447 x 447 x 9 mm
Farbe · Colour	grey	multicolor sand	multicolor grey	-
Oberfläche · Finish	VilboTouch matt Betonstruktur reliefiert · VilboTouch matt concrete texture relief VilbostonePlus	VilboTouch matt Betonstruktur reliefiert · VilboTouch matt concrete texture relief	VilboTouch matt Betonstruktur reliefiert · VilboTouch matt concrete texture relief	VilboTouch matt Betonstruktur · VilboTouch matt concrete texture VilbostonePlus
Erzeugnisgruppe	Feinsteinzeug	Feinsteinzeug glasiert	Feinsteinzeug glasiert	Feinsteinzeug
Material	Porcelain stoneware	Glazed porcelain stoneware	Glazed porcelain stoneware	Porcelain stoneware
Maßeinheit · Unit of measure	m ² 19,72 kg 2,78 pce	m ² 19,72 kg 2,78 pce	m ² 19,72 kg 2,78 pce	m ² 19,75 kg 4,94 pce
Pro Paket · Per box	1,44 m ² 28,40 kg 4 pce	1,44 m ² 28,40 kg 4 pce	1,44 m ² 28,40 kg 4 pce	1,42 m ² 28 kg 7 pce
Pro Palette · Per pallet	43,20 m ² 852 kg 30 box	43,20 m ² 852 kg 30 box	43,20 m ² 852 kg 30 box	36,86 m ² 728 kg 26 box
Mindestabgabereinheit · Min. sales unit	P (box)	P (box)	P (box)	P (box)
Berechnungseinheit · Calculation unit	m ²	m ²	m ²	m ²
Preisgruppe · Price group	P74	P117	P117	P71

PURE BASE Wohnen Basis · Living Basis

Concept³

				
	30 x 60 cm  2	30 x 60 cm  2	30 x 60 cm  2	30 x 60 cm  2
Artikelnummer · Article number	2360	2360	2360	2360
	BZ10    	BZ70    	BZ06    	BZ40    
Warengruppe · Product group	Grundfliese · Basic tile	Grundfliese · Basic tile	Grundfliese · Basic tile	Grundfliese · Basic tile
Werksmaße · Dimensions (mm)	297 x 597 x 9 mm	297 x 597 x 9 mm	297 x 597 x 9 mm	297 x 597 x 9 mm
Farbe · Colour	creme	sand grey	silver grey	medium grey
Oberfläche · Finish	VilboTouch matt Betonstruktur reliefiert · VilboTouch matt concrete texture relief VilbostonePlus	VilboTouch matt Betonstruktur reliefiert · VilboTouch matt concrete texture relief VilbostonePlus	VilboTouch matt Betonstruktur reliefiert · VilboTouch matt concrete texture relief VilbostonePlus	VilboTouch matt Betonstruktur reliefiert · VilboTouch matt concrete texture relief VilbostonePlus
Erzeugnisgruppe	Feinsteinzeug	Feinsteinzeug	Feinsteinzeug	Feinsteinzeug
Material	Porcelain stoneware	Porcelain stoneware	Porcelain stoneware	Porcelain stoneware
Maßeinheit · Unit of measure	m ² 18,67 kg 5,56 pce	m ² 18,67 kg 5,56 pce	m ² 18,67 kg 5,56 pce	m ² 18,67 kg 5,56 pce
Pro Paket · Per box	1,08 m ² 20,16 kg 6 pce	1,08 m ² 20,16 kg 6 pce	1,08 m ² 20,16 kg 6 pce	1,08 m ² 20,16 kg 6 pce
Pro Palette · Per pallet	43,20 m ² 806,40 kg 40 box	43,20 m ² 806,40 kg 40 box	43,20 m ² 806,40 kg 40 box	43,20 m ² 806,40 kg 40 box
Mindestabgabereinheit · Min. sales unit	P (box)	P (box)	P (box)	P (box)
Berechnungseinheit · Calculation unit	m ²	m ²	m ²	m ²
Preisgruppe · Price group	P71	P71	P71	P71
				
	30 x 60 cm  2	30 x 60 cm	30 x 60 cm	
Artikelnummer · Article number	2360	2360	2360	
	BZ60    	BZ75     	BZ65     	
Warengruppe · Product group	Grundfliese · Basic tile	Dekor · Decor	Dekor · Decor	
Werksmaße · Dimensions (mm)	297 x 597 x 9 mm	297 x 597 x 9 mm	297 x 597 x 9 mm	
Farbe · Colour	grey	multicolor sand	multicolor grey	
Oberfläche · Finish	VilboTouch matt Betonstruktur reliefiert · VilboTouch matt concrete texture relief VilbostonePlus	VilboTouch matt reliefiert · VilboTouch matt relief	VilboTouch matt reliefiert · VilboTouch matt relief	
Erzeugnisgruppe	Feinsteinzeug	Feinsteinzeug glasiert	Feinsteinzeug glasiert	
Material	Porcelain stoneware	Glazed porcelain stoneware	Glazed porcelain stoneware	
Maßeinheit · Unit of measure	m ² 18,67 kg 5,56 pce	m ² 18,67 kg 5,56 pce	m ² 18,67 kg 5,56 pce	
Pro Paket · Per box	1,08 m ² 20,16 kg 6 pce	1,08 m ² 20,16 kg 6 pce	1,08 m ² 20,16 kg 6 pce	
Pro Palette · Per pallet	43,20 m ² 806,40 kg 40 box	43,20 m ² 806,40 kg 40 box	43,20 m ² 806,40 kg 40 box	
Mindestabgabereinheit · Min. sales unit	P (box)	P (box)	P (box)	
Berechnungseinheit · Calculation unit	m ²	m ²	m ²	
Preisgruppe · Price group	P71	P109	P109	

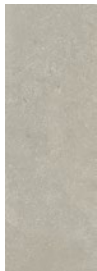
RESTONICA Wohnen · Living





			
	20 x 60 cm	20 x 60 cm	20 x 60 cm
Artikelnummer · Article number	1260	1260	1260
	SJ10	SJ70	SJ90
Warengruppe · Product group	Grundfliese · Basic tile	Grundfliese · Basic tile	Grundfliese · Basic tile
Werkmaße · Dimensions (mm)	197 x 597 x 9 mm	197 x 597 x 9 mm	197 x 597 x 9 mm
Farbe · Colour	creme	greige	anthracite
Oberfläche · Finish	matt CeramicPlus	matt CeramicPlus	matt CeramicPlus
Erzeugnisgruppe	Steingut	Steingut	Steingut
Material	Nonvitreous	Nonvitreous	Nonvitreous
Maßeinheit · Unit of measure	m ² 15,42 kg 8,33 pce	m ² 15,42 kg 8,33 pce	m ² 15,42 kg 8,33 pce
Pro Paket · Per box	1,08 m ² 16,65 kg 9 pce	1,08 m ² 16,65 kg 9 pce	1,08 m ² 16,65 kg 9 pce
Pro Palette · Per pallet	69,12 m ² 1065,60 kg 64 box	69,12 m ² 1065,60 kg 64 box	69,12 m ² 1065,60 kg 64 box
Mindestabgabereinheit · Min. sales unit	P (box)	P (box)	P (box)
Berechnungseinheit · Calculation unit	m ²	m ²	m ²
Preisgruppe · Price group	P73	P73	P73
	■ Pure Base 2733 BZ10, Rocky, Art 2735 CB70	■ Pure Base 2733 BZ40, Rocky, Art 2735 CB60	■ Pure Base 2733 BZ60, Rocky, Art 2735 CB90
			
	20 x 60 cm	20 x 60 cm	20 x 60 cm
Artikelnummer · Article number	1261	1261	1261
	SJ10	SJ70	SJ90
Warengruppe · Product group	Dekor · Decor	Dekor · Decor	Dekor · Decor
Werkmaße · Dimensions (mm)	197 x 597 x 9 mm	197 x 597 x 9 mm	197 x 597 x 9 mm
Farbe · Colour	creme	greige	anthracite
Oberfläche · Finish	matt reliefiert · matt relief CeramicPlus	matt reliefiert · matt relief CeramicPlus	matt reliefiert · matt relief CeramicPlus
Erzeugnisgruppe	Steingut	Steingut	Steingut
Material	Nonvitreous	Nonvitreous	Nonvitreous
Maßeinheit · Unit of measure	m ² 15,42 kg 8,33 pce	m ² 15,42 kg 8,33 pce	m ² 15,42 kg 8,33 pce
Pro Paket · Per box	1,08 m ² 16,65 kg 9 pce	1,08 m ² 16,65 kg 9 pce	1,08 m ² 16,65 kg 9 pce
Pro Palette · Per pallet	69,12 m ² 1065,60 kg 64 box	69,12 m ² 1065,60 kg 64 box	69,12 m ² 1065,60 kg 64 box
Mindestabgabereinheit · Min. sales unit	P (box)	P (box)	P (box)
Berechnungseinheit · Calculation unit	m ²	m ²	m ²
Preisgruppe · Price group	P84	P84	P84

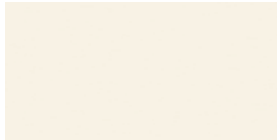
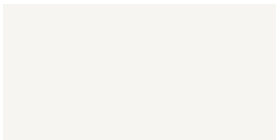
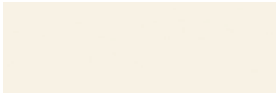
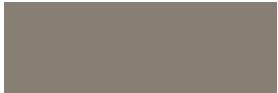
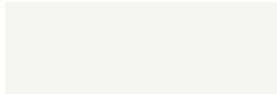

reddot winner 2020

Concept³

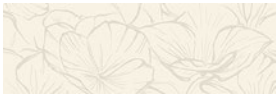
ROCKY.ART Wohnen · Living

				
	30 x 60 cm	30 x 60 cm	20 x 60 cm	20 x 60 cm
Artikelnummer · Article number	1581	1581	1260	1260
	CB10	CB00	CB10	CB70
Warengruppe · Product group	Grundfliese · Basic tile	Grundfliese · Basic tile	Grundfliese · Basic tile	Grundfliese · Basic tile
Werksmaße · Dimensions (mm)	297 x 597 x 9 mm	297 x 597 x 9 mm	197 x 597 x 9 mm	197 x 597 x 9 mm
Farbe · Colour	cotton	snow	cotton	fango
Oberfläche · Finish	PowderTouch CeramicPlus	PowderTouch CeramicPlus	PowderTouch CeramicPlus	PowderTouch CeramicPlus
Erzeugnisgruppe	Steingut	Steingut	Steingut	Steingut
Material	Nonvitreous	Nonvitreous	Nonvitreous	Nonvitreous
Maßeinheit · Unit of measure	m ² 15,56 kg 5,56 pce	m ² 15,56 kg 5,56 pce	m ² 15,42 kg 8,33 pce	m ² 15,42 kg 8,33 pce
Pro Paket · Per box	1,08 m ² 16,80 kg 6 pce	1,08 m ² 16,80 kg 6 pce	1,08 m ² 16,65 kg 9 pce	1,08 m ² 16,65 kg 9 pce
Pro Palette · Per pallet	51,84 m ² 806,40 kg 48 box	51,84 m ² 806,40 kg 48 box	69,12 m ² 1065,60 kg 64 box	69,12 m ² 1065,60 kg 64 box
Mindestabgabereinheit · Min. sales unit	P (box)	P (box)	P (box)	P (box)
Berechnungseinheit · Calculation unit	m ²	m ²	m ²	m ²
Preisgruppe · Price group	P87	P87	P76	P76
				
	20 x 60 cm	20 x 60 cm	20 x 60 cm	20 x 60 cm
Artikelnummer · Article number	1260	1260	1260 Floral	1260 Floral
	CB00	CB60	CB15	CB75
Warengruppe · Product group	Grundfliese · Basic tile	Grundfliese · Basic tile	Dekor · Decor	Dekor · Decor
Werksmaße · Dimensions (mm)	197 x 597 x 9 mm	197 x 597 x 9 mm	197 x 597 x 9 mm	197 x 597 x 9 mm
Farbe · Colour	snow	pebble	cotton	fango
Oberfläche · Finish	PowderTouch CeramicPlus	PowderTouch CeramicPlus	PowderTouch CeramicPlus	PowderTouch CeramicPlus
Erzeugnisgruppe	Steingut	Steingut	Steingut	Steingut
Material	Nonvitreous	Nonvitreous	Nonvitreous	Nonvitreous
Maßeinheit · Unit of measure	m ² 15,42 kg 8,33 pce	m ² 15,42 kg 8,33 pce	m ² 15,42 kg 8,33 pce	m ² 15,42 kg 8,33 pce
Pro Paket · Per box	1,08 m ² 16,65 kg 9 pce	1,08 m ² 16,65 kg 9 pce	1,08 m ² 16,65 kg 9 pce	1,08 m ² 16,65 kg 9 pce
Pro Palette · Per pallet	69,12 m ² 1065,60 kg 64 box	69,12 m ² 1065,60 kg 64 box	69,12 m ² 1065,60 kg 64 box	69,12 m ² 1065,60 kg 64 box
Mindestabgabereinheit · Min. sales unit	P (box)	P (box)	P (box)	P (box)
Berechnungseinheit · Calculation unit	m ²	m ²	m ²	m ²
Preisgruppe · Price group	P76	P76	P88	P88

ROCKY.ART Wohnen · Living



Concept³

	20 x 60 cm	20 x 60 cm	60 x 60 cm	60 x 60 cm
Artikelnummer · Article number	1260 Floral	1260 Floral	2376	2376
Warengruppe · Product group	CB05	CB65	CB10	CB70
Werksmaße · Dimensions (mm)	Dekor · Decor 197 x 597 x 9 mm	Dekor · Decor 197 x 597 x 9 mm	Grundfliese · Basic tile 597 x 597 x 10 mm	Grundfliese · Basic tile 597 x 597 x 10 mm
Farbe · Colour	snow	pebble	white sand	fango
Oberfläche · Finish	PowderTouch CeramicPlus	PowderTouch CeramicPlus	matt Naturstein-Betnoptik reliefiert · matt stone-concrete look relief VilbostonePlus	matt Naturstein-Betnoptik reliefiert · matt stone-concrete look relief VilbostonePlus
Erzeugnisgruppe	Steingut	Steingut	Feinsteinzeug	Feinsteinzeug
Material	Nonvitreous	Nonvitreous	Porcelain stoneware	Porcelain stoneware
Maßeinheit · Unit of measure	m ² 15,42 kg 8,33 pce	m ² 15,42 kg 8,33 pce	m ² 22,22 kg 2,78 pce	m ² 22,22 kg 2,78 pce
Pro Paket · Per box	1,08 m ² 16,65 kg 9 pce	1,08 m ² 16,65 kg 9 pce	1,44 m ² 32 kg 4 pce	1,44 m ² 32 kg 4 pce
Pro Palette · Per pallet	69,12 m ² 1065,60 kg 64 box	69,12 m ² 1065,60 kg 64 box	43,20 m ² 960 kg 30 box	43,20 m ² 960 kg 30 box
Mindestabgabereinheit · Min. sales unit	P (box)	P (box)	P (box)	P (box)
Berechnungseinheit · Calculation unit	m ²	m ²	m ²	m ²
Preisgruppe · Price group	P88	P88	P99	P99
	60 x 60 cm	60 x 60 cm	45 x 45 cm	30 x 60 cm
Artikelnummer · Article number	2376	2376	2735	2377
Warengruppe · Product group	CB60	CB90	CB10, CB60, CB70 CB90	CB10
Werksmaße · Dimensions (mm)	Grundfliese · Basic tile 597 x 597 x 10 mm	Grundfliese · Basic tile 597 x 597 x 10 mm	Grundfliese · Basic tile 447 x 447 x 9 mm	Grundfliese · Basic tile 297 x 597 x 10 mm
Farbe · Colour	pebble	basalt	-	white sand
Oberfläche · Finish	matt Naturstein-Betnoptik reliefiert · matt stone-concrete look relief VilbostonePlus	matt Naturstein-Betnoptik reliefiert · matt stone-concrete look relief VilbostonePlus	matt Naturstein-Betnoptik reliefiert · matt stone-concrete look relief VilbostonePlus	matt Naturstein-Betnoptik reliefiert · matt stone-concrete look relief VilbostonePlus
Erzeugnisgruppe	Feinsteinzeug	Feinsteinzeug	Feinsteinzeug	Feinsteinzeug
Material	Porcelain stoneware	Porcelain stoneware	Porcelain stoneware	Porcelain stoneware
Maßeinheit · Unit of measure	m ² 22,22 kg 2,78 pce	m ² 22,22 kg 2,78 pce	m ² 22,22 kg 4,94 pce	m ² 22,22 kg 5,56 pce
Pro Paket · Per box	1,44 m ² 32 kg 4 pce	1,44 m ² 32 kg 4 pce	1,42 m ² 31,50 kg 7 pce	1,08 m ² 24 kg 6 pce
Pro Palette · Per pallet	43,20 m ² 960 kg 30 box	43,20 m ² 960 kg 30 box	36,86 m ² 819 kg 26 box	43,20 m ² 960 kg 40 box
Mindestabgabereinheit · Min. sales unit	P (box)	P (box)	P (box)	P (box)
Berechnungseinheit · Calculation unit	m ²	m ²	m ²	m ²
Preisgruppe · Price group	P99	P99	P79	P87

ROCKY.ART Wohnen · Living



Concept³



30 x 60 cm

Artikelnummer · Article number	2377
Warengruppe · Product group	Grundfliese · Basic tile
Werkmaße · Dimensions (mm)	297 x 597 x 10 mm
Farbe · Colour	fango
Oberfläche · Finish	matt Naturstein-Betonoptik reliefiert · matt stone-concrete look relief
Erzeugnisgruppe	Feinsteinzeug
Material	Porcelain stoneware
Maßeinheit · Unit of measure	m ² 22,22 kg 5,56 pce
Pro Paket · Per box	1,08 m ² 24 kg 6 pce
Pro Palette · Per pallet	43,20 m ² 960 kg 40 box
Mindestabgabeneinheit · Min. sales unit	P (box)
Berechnungseinheit · Calculation unit	m ²
Preisgruppe · Price group	P87



30 x 60 cm

Artikelnummer · Article number	2377
Warengruppe · Product group	Grundfliese · Basic tile
Werkmaße · Dimensions (mm)	297 x 597 x 10 mm
Farbe · Colour	pebble
Oberfläche · Finish	matt Naturstein-Betonoptik reliefiert · matt stone-concrete look relief
Erzeugnisgruppe	Feinsteinzeug
Material	Porcelain stoneware
Maßeinheit · Unit of measure	m ² 22,22 kg 5,56 pce
Pro Paket · Per box	1,08 m ² 24 kg 6 pce
Pro Palette · Per pallet	43,20 m ² 960 kg 40 box
Mindestabgabeneinheit · Min. sales unit	P (box)
Berechnungseinheit · Calculation unit	m ²
Preisgruppe · Price group	P87



30 x 60 cm

Artikelnummer · Article number	2377
Warengruppe · Product group	Grundfliese · Basic tile
Werkmaße · Dimensions (mm)	297 x 597 x 10 mm
Farbe · Colour	basalt
Oberfläche · Finish	matt Naturstein-Betonoptik reliefiert · matt stone-concrete look relief
Erzeugnisgruppe	Feinsteinzeug
Material	Porcelain stoneware
Maßeinheit · Unit of measure	m ² 22,22 kg 5,56 pce
Pro Paket · Per box	1,08 m ² 24 kg 6 pce
Pro Palette · Per pallet	43,20 m ² 960 kg 40 box
Mindestabgabeneinheit · Min. sales unit	P (box)
Berechnungseinheit · Calculation unit	m ²
Preisgruppe · Price group	P87



60 x 120 cm

Artikelnummer · Article number	2730
Warengruppe · Product group	Dekor · Decor
Werkmaße · Dimensions (mm)	597 x 1197 x 10 mm
Farbe · Colour	limelight
Oberfläche · Finish	VilboTouch matt Naturstein-Betonoptik · VilboTouch matt stone-concrete look
Erzeugnisgruppe	Feinsteinzeug glasiert
Material	Glazed porcelain stoneware
Maßeinheit · Unit of measure	m ² 21,28 kg 1,39 pce
Pro Paket · Per box	1,44 m ² 30,64 kg 2 pce
Pro Palette · Per pallet	43,2 m ² 919,2 kg 30 box
Mindestabgabeneinheit · Min. sales unit	P (box)
Berechnungseinheit · Calculation unit	m ²
Preisgruppe · Price group	P134



30 x 120 cm

Artikelnummer · Article number	2356
Warengruppe · Product group	Dekor · Decor
Werkmaße · Dimensions (mm)	297 x 1197 x 10 mm
Farbe · Colour	limelight
Oberfläche · Finish	VilboTouch matt Naturstein-Betonoptik · VilboTouch matt stone-concrete look
Erzeugnisgruppe	Feinsteinzeug glasiert
Material	Glazed porcelain stoneware
Maßeinheit · Unit of measure	m ² 22,22 kg 2,78 pce
Pro Paket · Per box	1,44 m ² 32 kg 4 pce
Pro Palette · Per pallet	43,20 m ² 960 kg 30 box
Mindestabgabeneinheit · Min. sales unit	P (box)
Berechnungseinheit · Calculation unit	m ²
Preisgruppe · Price group	P145



30 x 30 cm

Artikelnummer · Article number	2379
Warengruppe · Product group	Dekor · Decor
Werkmaße · Dimensions (mm)	298 x 298 x 10 mm
Farbe · Colour	white sand
Oberfläche · Finish	matt Naturstein-Betonoptik reliefiert · matt stone-concrete look relief
Erzeugnisgruppe	Feinsteinzeug
Material	Porcelain stoneware
Maßeinheit · Unit of measure	m ² 22 kg 11 pce
Pro Paket · Per box	1 m ² 22 kg 11 pce
Pro Palette · Per pallet	36 m ² 792 kg 36 box
Mindestabgabeneinheit · Min. sales unit	P (box)
Berechnungseinheit · Calculation unit	m ²
Preisgruppe · Price group	P199



30 x 30 cm

Artikelnummer · Article number	2379
Warengruppe · Product group	Dekor · Decor
Werkmaße · Dimensions (mm)	298 x 298 x 10 mm
Farbe · Colour	fango
Oberfläche · Finish	matt Naturstein-Betonoptik reliefiert · matt stone-concrete look relief
Erzeugnisgruppe	Feinsteinzeug
Material	Porcelain stoneware
Maßeinheit · Unit of measure	m ² 22 kg 11 pce
Pro Paket · Per box	1 m ² 22 kg 11 pce
Pro Palette · Per pallet	36 m ² 792 kg 36 box
Mindestabgabeneinheit · Min. sales unit	P (box)
Berechnungseinheit · Calculation unit	m ²
Preisgruppe · Price group	P199



30 x 30 cm

Artikelnummer · Article number	2379
Warengruppe · Product group	Dekor · Decor
Werkmaße · Dimensions (mm)	298 x 298 x 10 mm
Farbe · Colour	fango
Oberfläche · Finish	matt Naturstein-Betonoptik reliefiert · matt stone-concrete look relief
Erzeugnisgruppe	Feinsteinzeug
Material	Porcelain stoneware
Maßeinheit · Unit of measure	m ² 22 kg 11 pce
Pro Paket · Per box	1 m ² 22 kg 11 pce
Pro Palette · Per pallet	36 m ² 792 kg 36 box
Mindestabgabeneinheit · Min. sales unit	P (box)
Berechnungseinheit · Calculation unit	m ²
Preisgruppe · Price group	P199

ROCKY.ART Wohnen · Living



reddot winner 2020

Concept³

	30 x 30 cm □ 0,09 m ² 298 x 298 mm	30 x 30 cm □ 0,09 m ² 298 x 298 mm	7,5 x 7,5 cm □ 0,09 m ² 297 x 297 mm	7,5 x 7,5 cm □ 0,09 m ² 297 x 297 mm
Artikelnummer · Article number	2379	2379	2013	2013
Warengruppe · Product group	CB60	CB90	CB10	CB70
Werkmaße · Dimensions (mm)	Dekor · Decor 298 x 298 x 10 mm	Dekor · Decor 298 x 298 x 10 mm	Grundfliese · Basic tile 72 x 72 x 10 mm	Grundfliese · Basic tile 72 x 72 x 10 mm
Farbe · Colour	pebble	basalt	white sand	fango
Oberfläche · Finish	matt Naturstein-Betonoptik reliefiert · matt stone-concrete look relief VilbostonePlus	matt Naturstein-Betonoptik reliefiert · matt stone-concrete look relief VilbostonePlus	matt Naturstein-Betonoptik reliefiert · matt stone-concrete look relief VilbostonePlus	matt Naturstein-Betonoptik reliefiert · matt stone-concrete look relief VilbostonePlus
Erzeugnisgruppe	Feinsteinzeug	Feinsteinzeug	Feinsteinzeug	Feinsteinzeug
Material	Porcelain stoneware	Porcelain stoneware	Porcelain stoneware	Porcelain stoneware
Maßeinheit · Unit of measure	m ² 22 kg 11 pce	m ² 22 kg 11 pce	m ² 20,90 kg 11 pce	m ² 20,90 kg 11 pce
Pro Paket · Per box	1 m ² 22 kg 11 pce	1 m ² 22 kg 11 pce	1 m ² 20,90 kg 11 pce	1 m ² 20,90 kg 11 pce
Pro Palette · Per pallet	36 m ² 792 kg 36 box	36 m ² 792 kg 36 box	36 m ² 752,40 kg 36 box	36 m ² 752,40 kg 36 box
Mindestabgabereinheit · Min. sales unit	P (box)	P (box)	P (box)	P (box)
Berechnungseinheit · Calculation unit	m ²	m ²	m ²	m ²
Preisgruppe · Price group	P199	P199	P178	P178
	7,5 x 7,5 cm □ 0,09 m ² 297 x 297 mm	7,5 x 7,5 cm □ 0,09 m ² 297 x 297 mm	7,5 x 60 cm	8 x 45 cm
Artikelnummer · Article number	2013	2013	2872	2717
Warengruppe · Product group	CB60	CB90	CB10, CB60, CB70 CB90	CB10, CB60, CB70 CB90
Werkmaße · Dimensions (mm)	Grundfliese · Basic tile 72 x 72 x 10 mm	Grundfliese · Basic tile 72 x 72 x 10 mm	Sockel · Skirting 72 x 597 x 10 mm	Sockel · Skirting 80 x 449 x 9 mm
Farbe · Colour	pebble	basalt	-	-
Oberfläche · Finish	matt Naturstein-Betonoptik reliefiert · matt stone-concrete look relief VilbostonePlus	matt Naturstein-Betonoptik reliefiert · matt stone-concrete look relief VilbostonePlus	matt Naturstein-Betonoptik reliefiert · matt stone-concrete look relief VilbostonePlus	matt Naturstein-Betonoptik · matt stone-concrete look
Erzeugnisgruppe	Feinsteinzeug	Feinsteinzeug	Feinsteinzeug	Feinsteinzeug
Material	Porcelain stoneware	Porcelain stoneware	Porcelain stoneware	Porcelain stoneware
Maßeinheit · Unit of measure	m ² 20,90 kg 11 pce	m ² 20,90 kg 11 pce	m 1,63 kg 1,66 pce	m 2,06 kg 2,22 pce
Pro Paket · Per box	1 m ² 20,90 kg 11 pce	1 m ² 20,90 kg 11 pce	12,05 m 19,60 kg 20 pce	11,26 m 23,25 kg 25 pce
Pro Palette · Per pallet	36 m ² 752,40 kg 36 box	36 m ² 752,40 kg 36 box	578,31 m 940,80 kg 48 box	540,54 m 1116 kg 48 box
Mindestabgabereinheit · Min. sales unit	P (box)	P (box)	E (pce)	E (pce)
Berechnungseinheit · Calculation unit	m ²	m ²	Stück · piece	Stück · piece
Preisgruppe · Price group	P178	P178	E52	E43

SECTION Wohnen Basis · Living Basis

	60 x 60 cm	60 x 60 cm	60 x 60 cm	60 x 60 cm
Artikelnummer · Article number	2349	2349	2349	2349
	SZ00	SZ10	SZ60	SZ90
Warengruppe · Product group	Grundfliese · Basic tile	Grundfliese · Basic tile	Grundfliese · Basic tile	Grundfliese · Basic tile
Werkmaße · Dimensions (mm)	597 x 597 x 9 mm	597 x 597 x 9 mm	597 x 597 x 9 mm	597 x 597 x 9 mm
Farbe · Colour	creme-weiß · creme-white	sandbeige	zementgrau · cement grey	anthrazit · anthracite
Oberfläche · Finish	matt VilbostonePlus	matt VilbostonePlus	matt VilbostonePlus	matt VilbostonePlus
Erzeugnisgruppe	Feinsteinzeug	Feinsteinzeug	Feinsteinzeug	Feinsteinzeug
Material	Porcelain stoneware	Porcelain stoneware	Porcelain stoneware	Porcelain stoneware
Maßeinheit · Unit of measure	m ² 18,69 kg 2,78 pce	m ² 18,69 kg 2,78 pce	m ² 18,69 kg 2,78 pce	m ² 18,69 kg 2,78 pce
Pro Paket · Per box	1,44 m ² 26,92 kg 4 pce	1,44 m ² 26,92 kg 4 pce	1,44 m ² 26,92 kg 4 pce	1,44 m ² 26,92 kg 4 pce
Pro Palette · Per pallet	43,2 m ² 807,6 kg 30 box	43,2 m ² 807,6 kg 30 box	43,2 m ² 807,6 kg 30 box	43,2 m ² 807,6 kg 30 box
Mindestabgabeneinheit · Min. sales unit	P (box)	P (box)	P (box)	P (box)
Berechnungseinheit · Calculation unit	m ²	m ²	m ²	m ²
Preisgruppe · Price group	P74	P74	P74	P74
	30 x 60 cm	30 x 60 cm	30 x 60 cm	30 x 60 cm
Artikelnummer · Article number	2085	2085	2085	2085
	SZ00	SZ10	SZ60	SZ90
Warengruppe · Product group	Grundfliese · Basic tile	Grundfliese · Basic tile	Grundfliese · Basic tile	Grundfliese · Basic tile
Werkmaße · Dimensions (mm)	297 x 597 x 9 mm	297 x 597 x 9 mm	297 x 597 x 9 mm	297 x 597 x 9 mm
Farbe · Colour	creme-weiß · creme-white	sandbeige	zementgrau · cement grey	anthrazit · anthracite
Oberfläche · Finish	matt VilbostonePlus	matt VilbostonePlus	matt VilbostonePlus	matt VilbostonePlus
Erzeugnisgruppe	Feinsteinzeug	Feinsteinzeug	Feinsteinzeug	Feinsteinzeug
Material	Porcelain stoneware	Porcelain stoneware	Porcelain stoneware	Porcelain stoneware
Maßeinheit · Unit of measure	m ² 18,67 kg 5,56 pce	m ² 18,67 kg 5,56 pce	m ² 18,67 kg 5,56 pce	m ² 18,67 kg 5,56 pce
Pro Paket · Per box	1,08 m ² 20,16 kg 6 pce	1,08 m ² 20,16 kg 6 pce	1,08 m ² 20,16 kg 6 pce	1,08 m ² 20,16 kg 6 pce
Pro Palette · Per pallet	43,2 m ² 806,4 kg 40 box	43,2 m ² 806,4 kg 40 box	43,2 m ² 806,4 kg 40 box	43,2 m ² 806,4 kg 40 box
Mindestabgabeneinheit · Min. sales unit	P (box)	P (box)	P (box)	P (box)
Berechnungseinheit · Calculation unit	m ²	m ²	m ²	m ²
Preisgruppe · Price group	P93	P93	P93	P93
	30 x 50 cm	30 x 50 cm	30 x 50 cm	30 x 50 cm
	<input type="checkbox"/> 0,15 m ² 298 x 498 mm	<input type="checkbox"/> 0,15 m ² 298 x 498 mm	<input type="checkbox"/> 0,15 m ² 298 x 498 mm	<input type="checkbox"/> 0,15 m ² 298 x 498 mm
Artikelnummer · Article number	2652	2652	2652	2652
	SZ00	SZ10	SZ60	SZ90
Warengruppe · Product group	Dekor · Decor	Dekor · Decor	Dekor · Decor	Dekor · Decor
Werkmaße · Dimensions (mm)	298 x 498 x 10 mm	298 x 498 x 10 mm	298 x 498 x 10 mm	298 x 498 x 10 mm
Farbe · Colour	creme-weiß · creme-white	sandbeige	zementgrau · cement grey	anthrazit · anthracite
Oberfläche · Finish	matt VilbostonePlus	matt VilbostonePlus	matt VilbostonePlus	matt VilbostonePlus
Erzeugnisgruppe	Feinsteinzeug	Feinsteinzeug	Feinsteinzeug	Feinsteinzeug
Material	Porcelain stoneware	Porcelain stoneware	Porcelain stoneware	Porcelain stoneware
Maßeinheit · Unit of measure	m ² 23,33 kg 6,67 pce	m ² 23,33 kg 6,67 pce	m ² 23,33 kg 6,67 pce	m ² 23,33 kg 6,67 pce
Pro Paket · Per box	0,75 m ² 17,50 kg 5 pce	0,75 m ² 17,50 kg 5 pce	0,75 m ² 17,50 kg 5 pce	0,75 m ² 17,50 kg 5 pce
Pro Palette · Per pallet	22,50 m ² 525 kg 30 box	22,50 m ² 525 kg 30 box	22,50 m ² 525 kg 30 box	22,50 m ² 525 kg 30 box
Mindestabgabeneinheit · Min. sales unit	P (box)	P (box)	P (box)	P (box)
Berechnungseinheit · Calculation unit	m ²	m ²	m ²	m ²
Preisgruppe · Price group	P170	P170	P170	P170

SECTION Wohnen Basis · Living Basis

5 x 5 cm 0,09 m ² 298 x 298 mm	5 x 5 cm 0,09 m ² 298 x 298 mm	5 x 5 cm 0,09 m ² 298 x 298 mm	5 x 5 cm 0,09 m ² 298 x 298 mm
2031	2031	2031	2031
SZ00	SZ10	SZ60	SZ90
Grundfliese - Basic tile	Grundfliese - Basic tile	Grundfliese - Basic tile	Grundfliese - Basic tile
Werksmaße - Dimensions (mm) 48 x 48 x 10 mm	Werksmaße - Dimensions (mm) 48 x 48 x 10 mm	Werksmaße - Dimensions (mm) 48 x 48 x 10 mm	Werksmaße - Dimensions (mm) 48 x 48 x 10 mm
Farbe - Colour creme-weiß · creme-white	Farbe - Colour sandbeige	Farbe - Colour zementgrau · cement grey	Farbe - Colour anthrazit · anthracite
Oberfläche - Finish matt VilbostonePlus	Oberfläche - Finish matt VilbostonePlus	Oberfläche - Finish matt VilbostonePlus	Oberfläche - Finish matt VilbostonePlus
Erzeugnisgruppe Feinsteinzeug	Erzeugnisgruppe Feinsteinzeug	Erzeugnisgruppe Feinsteinzeug	Erzeugnisgruppe Feinsteinzeug
Material Porcelain stoneware	Material Porcelain stoneware	Material Porcelain stoneware	Material Porcelain stoneware
Maßeinheit - Unit of measure m ² 22 kg 11 pce	Maßeinheit - Unit of measure m ² 22 kg 11 pce	Maßeinheit - Unit of measure m ² 22 kg 11 pce	Maßeinheit - Unit of measure m ² 22 kg 11 pce
Pro Paket - Per box 1 m ² 22 kg 11 pce	Pro Paket - Per box 1 m ² 22 kg 11 pce	Pro Paket - Per box 1 m ² 22 kg 11 pce	Pro Paket - Per box 1 m ² 22 kg 11 pce
Pro Palette - Per pallet 36 m ² 792 kg 36 box	Pro Palette - Per pallet 36 m ² 792 kg 36 box	Pro Palette - Per pallet 36 m ² 792 kg 36 box	Pro Palette - Per pallet 36 m ² 792 kg 36 box
Mindestabgabereinheit - Min. sales unit P (box)	Mindestabgabereinheit - Min. sales unit P (box)	Mindestabgabereinheit - Min. sales unit P (box)	Mindestabgabereinheit - Min. sales unit P (box)
Berechnungseinheit - Calculation unit m ²	Berechnungseinheit - Calculation unit m ²	Berechnungseinheit - Calculation unit m ²	Berechnungseinheit - Calculation unit m ²
Preisgruppe - Price group P166	Preisgruppe - Price group P166	Preisgruppe - Price group P166	Preisgruppe - Price group P166
7,5 x 60 cm			
2421			
SZ00, SZ10, SZ60			
SZ90			
Sockel · Skirting			
Werksmaße - Dimensions (mm) 72 x 597 x 10 mm			
Farbe - Colour -			
Oberfläche - Finish matt VilbostonePlus			
Erzeugnisgruppe Feinsteinzeug			
Material Porcelain stoneware			
Maßeinheit - Unit of measure m 1,49 kg 1,66 pce			
Pro Paket - Per box 12,05 m 18 kg 20 pce			
Pro Palette - Per pallet 578,31 m 864 kg 48 box			
Mindestabgabereinheit - Min. sales unit E (pce)			
Berechnungseinheit - Calculation unit Stück · piece			
Preisgruppe - Price group E52			

SILENT MOOD Wohnen Basis · Living Basis

30 x 60 cm NEW 2023	30 x 60 cm NEW 2023	30 x 60 cm NEW 2023	30 x 60 cm NEW 2023
1571	1571	1571	1571
CG60	CG10	CG30	CG40
Grundfliese - Basic tile	Grundfliese - Basic tile	Grundfliese - Basic tile	Grundfliese - Basic tile
Werksmaße - Dimensions (mm) 297 x 597 x 9 mm	Werksmaße - Dimensions (mm) 297 x 597 x 9 mm	Werksmaße - Dimensions (mm) 297 x 597 x 9 mm	Werksmaße - Dimensions (mm) 297 x 597 x 9 mm
Farbe - Colour light grey	Farbe - Colour creme	Farbe - Colour pink	Farbe - Colour blue
Oberfläche - Finish matt Zementstruktur · matt cement texture CeramicPlus	Oberfläche - Finish matt Zementstruktur · matt cement texture CeramicPlus	Oberfläche - Finish matt Zementstruktur · matt cement texture CeramicPlus	Oberfläche - Finish matt Zementstruktur · matt cement texture CeramicPlus
Erzeugnisgruppe Steingut	Erzeugnisgruppe Steingut	Erzeugnisgruppe Steingut	Erzeugnisgruppe Steingut
Material Nonvitreous	Material Nonvitreous	Material Nonvitreous	Material Nonvitreous
Maßeinheit - Unit of measure m ² 15,56 kg 5,56 pce	Maßeinheit - Unit of measure m ² 15,56 kg 5,56 pce	Maßeinheit - Unit of measure m ² 15,56 kg 5,56 pce	Maßeinheit - Unit of measure m ² 15,56 kg 5,56 pce
Pro Paket - Per box 1,08 m ² 16,80 kg 6 pce	Pro Paket - Per box 1,08 m ² 16,80 kg 6 pce	Pro Paket - Per box 1,08 m ² 16,80 kg 6 pce	Pro Paket - Per box 1,08 m ² 16,80 kg 6 pce
Pro Palette - Per pallet 51,84 m ² 806,40 kg 48 box	Pro Palette - Per pallet 51,84 m ² 806,40 kg 48 box	Pro Palette - Per pallet 51,84 m ² 806,40 kg 48 box	Pro Palette - Per pallet 51,84 m ² 806,40 kg 48 box
Mindestabgabereinheit - Min. sales unit P (box)	Mindestabgabereinheit - Min. sales unit P (box)	Mindestabgabereinheit - Min. sales unit P (box)	Mindestabgabereinheit - Min. sales unit P (box)
Berechnungseinheit - Calculation unit m ²	Berechnungseinheit - Calculation unit m ²	Berechnungseinheit - Calculation unit m ²	Berechnungseinheit - Calculation unit m ²
Preisgruppe - Price group P71	Preisgruppe - Price group P71	Preisgruppe - Price group P71	Preisgruppe - Price group P71
Ohio 2310 CJ61 / 2310 CJ62	Ohio 2310 CJ20	Ohio 2310 CJ20	Ohio 2310 CJ61 / 2310 CJ62









SILENT MOOD Wohnen Basis · Living Basis

	30 x 60 cm NEW 2023	30 x 60 cm NEW 2023	30 x 60 cm NEW 2023	30 x 60 cm NEW 2023
Artikelnummer · Article number	1571	1571	1571	1571
Warengruppe · Product group	CG50	CG61	CG11	CG31
Werkgröße · Dimensions (mm)	Grundfliese · Basic tile	Dekor · Decor	Dekor · Decor	Dekor · Decor
Farbe · Colour	297 x 597 x 9 mm	297 x 597 x 9 mm	297 x 597 x 9 mm	297 x 597 x 9 mm
Oberfläche · Finish	green	light grey	creme	pink
Erzeugnisgruppe	matt Zementstruktur · matt cement texture CeramicPlus	matt Zementstruktur · matt cement texture CeramicPlus	matt Zementstruktur · matt cement texture CeramicPlus	matt Zementstruktur · matt cement texture CeramicPlus
Material	Steingut	Steingut	Steingut	Steingut
Maßeinheit · Unit of measure	Nonvitreous	Nonvitreous	Nonvitreous	Nonvitreous
Pro Paket · Per box	m ² 15,56 kg 5,56 pce	m ² 15,56 kg 5,56 pce	m ² 15,56 kg 5,56 pce	m ² 15,56 kg 5,56 pce
Pro Palette · Per pallet	1,08 m ² 16,80 kg 6 pce	1,08 m ² 16,80 kg 6 pce	1,08 m ² 16,80 kg 6 pce	1,08 m ² 16,80 kg 6 pce
Mindestabgabereinheit · Min. sales unit	51,84 m ² 806,40 kg 48 box	51,84 m ² 806,40 kg 48 box	51,84 m ² 806,40 kg 48 box	51,84 m ² 806,40 kg 48 box
Berechnungseinheit · Calculation unit	P (box)	P (box)	P (box)	P (box)
Preisgruppe · Price group	m ² P71	m ² P87	m ² P87	m ² P87
	■ Ohio 2310 CJ10 / 2310 CJ60	Zwei Dekorvarianten, zufällig im Paket verpackt Two décor variants, random selection in each box	Zwei Dekorvarianten, zufällig im Paket verpackt Two décor variants, random selection in each box	Zwei Dekorvarianten, zufällig im Paket verpackt Two décor variants, random selection in each box
	30 x 60 cm NEW 2023	30 x 60 cm NEW 2023	30 x 60 cm NEW 2023	30 x 60 cm NEW 2023
Artikelnummer · Article number	1571	1571	1574	1574
Warengruppe · Product group	CG41	CG51	CG60	CG10
Werkgröße · Dimensions (mm)	Dekor · Decor	Dekor · Decor	Dekor · Decor	Dekor · Decor
Farbe · Colour	297 x 597 x 9 mm	297 x 597 x 9 mm	297 x 597 x 9 mm	297 x 597 x 9 mm
Oberfläche · Finish	blue	green	light grey	creme
Erzeugnisgruppe	matt Zementstruktur · matt cement texture CeramicPlus	matt Zementstruktur · matt cement texture CeramicPlus	matt Zementstruktur reliefiert · matt cement texture relief CeramicPlus	matt Zementstruktur reliefiert · matt cement texture relief CeramicPlus
Material	Steingut	Steingut	Steingut	Steingut
Maßeinheit · Unit of measure	Nonvitreous	Nonvitreous	Nonvitreous	Nonvitreous
Pro Paket · Per box	m ² 15,56 kg 5,56 pce	m ² 15,56 kg 5,56 pce	m ² 15,56 kg 5,56 pce	m ² 15,56 kg 5,56 pce
Pro Palette · Per pallet	1,08 m ² 16,80 kg 6 pce	1,08 m ² 16,80 kg 6 pce	1,08 m ² 16,80 kg 6 pce	1,08 m ² 16,80 kg 6 pce
Mindestabgabereinheit · Min. sales unit	51,84 m ² 806,40 kg 48 box	51,84 m ² 806,40 kg 48 box	51,84 m ² 806,40 kg 48 box	51,84 m ² 806,40 kg 48 box
Berechnungseinheit · Calculation unit	P (box)	P (box)	P (box)	P (box)
Preisgruppe · Price group	m ² P87	m ² P87	m ² P87	m ² P87
	Zwei Dekorvarianten, zufällig im Paket verpackt Two décor variants, random selection in each box	Zwei Dekorvarianten, zufällig im Paket verpackt Two décor variants, random selection in each box		
	30 x 60 cm NEW 2023	30 x 60 cm NEW 2023	30 x 60 cm NEW 2023	
Artikelnummer · Article number	1574	1574	1574	
Warengruppe · Product group	CG30	CG40	CG50	
Werkgröße · Dimensions (mm)	Dekor · Decor	Dekor · Decor	Dekor · Decor	
Farbe · Colour	297 x 597 x 9 mm	297 x 597 x 9 mm	297 x 597 x 9 mm	
Oberfläche · Finish	pink	blue	green	
Erzeugnisgruppe	matt Zementstruktur reliefiert · matt cement texture relief CeramicPlus	matt Zementstruktur reliefiert · matt cement texture relief CeramicPlus	matt Zementstruktur reliefiert · matt cement texture relief CeramicPlus	
Material	Steingut	Steingut	Steingut	
Maßeinheit · Unit of measure	Nonvitreous	Nonvitreous	Nonvitreous	
Pro Paket · Per box	m ² 15,56 kg 5,56 pce	m ² 15,56 kg 5,56 pce	m ² 15,56 kg 5,56 pce	
Pro Palette · Per pallet	1,08 m ² 16,80 kg 6 pce	1,08 m ² 16,80 kg 6 pce	1,08 m ² 16,80 kg 6 pce	
Mindestabgabereinheit · Min. sales unit	51,84 m ² 806,40 kg 48 box	51,84 m ² 806,40 kg 48 box	51,84 m ² 806,40 kg 48 box	
Berechnungseinheit · Calculation unit	P (box)	P (box)	P (box)	
Preisgruppe · Price group	m ² P87	m ² P87	m ² P87	

SOFT COLOURS Wohnen · Living

				
	33 x 99 cm	33 x 99 cm	33 x 99 cm	33 x 99 cm
Artikelnummer · Article number	1312	1313	1312	1313
Warengruppe · Product group	Grundfliese · Basic tile	Dekor · Decor	Grundfliese · Basic tile	Dekor · Decor
Werkmaße · Dimensions (mm)	329 x 991 x 11 mm	329 x 991 x 11 mm	329 x 991 x 11 mm	329 x 991 x 11 mm
Farbe · Colour	soft white	soft white	cotton	cotton
Oberfläche · Finish	matt Spachteloptik · matt	matt Spachteloptik reliefiert · matt relief	matt Spachteloptik · matt	matt Spachteloptik reliefiert · matt relief
Erzeugnisgruppe	Steingut	Steingut	Steingut	Steingut
Material	Nonvitreous	Nonvitreous	Nonvitreous	Nonvitreous
Maßeinheit · Unit of measure	m ² 19,137 kg 3,06 pce	m ² 19,137 kg 3,06 pce	m ² 19,137 kg 3,06 pce	m ² 19,137 kg 3,06 pce
Pro Paket · Per box	1,31 m ² 25 kg 4 pce	1,31 m ² 25 kg 4 pce	1,31 m ² 25 kg 4 pce	1,31 m ² 25 kg 4 pce
Pro Palette · Per pallet	36,59 m ² 700 kg 28 box	36,59 m ² 700 kg 28 box	36,59 m ² 700 kg 28 box	36,59 m ² 700 kg 28 box
Mindestabgabereinheit · Min. sales unit	P (box)	P (box)	P (box)	P (box)
Berechnungseinheit · Calculation unit	m ²	m ²	m ²	m ²
Preisgruppe · Price group	P105	P122	P105	P122
				
	30 x 60 cm	30 x 60 cm	30 x 60 cm	30 x 60 cm
Artikelnummer · Article number	1582	1583	1582	1583
Warengruppe · Product group	Grundfliese · Basic tile	Dekor · Decor	Grundfliese · Basic tile	Dekor · Decor
Werkmaße · Dimensions (mm)	297 x 597 x 9 mm	297 x 597 x 9 mm	297 x 597 x 9 mm	297 x 597 x 9 mm
Farbe · Colour	soft white	soft white	cotton	cotton
Oberfläche · Finish	matt Spachteloptik · matt Trowelled look	matt Spachteloptik reliefiert · matt relief	matt Spachteloptik · matt Trowelled look	matt Spachteloptik reliefiert · matt relief
Erzeugnisgruppe	Steingut	Steingut	Steingut	Steingut
Material	Nonvitreous	Nonvitreous	Nonvitreous	Nonvitreous
Maßeinheit · Unit of measure	m ² 15,56 kg 5,56 pce	m ² 15,56 kg 5,56 pce	m ² 15,56 kg 5,56 pce	m ² 15,56 kg 5,56 pce
Pro Paket · Per box	1,08 m ² 16,80 kg 6 pce	1,08 m ² 16,80 kg 6 pce	1,08 m ² 16,80 kg 6 pce	1,08 m ² 16,80 kg 6 pce
Pro Palette · Per pallet	51,84 m ² 806,40 kg 48 box	51,84 m ² 806,40 kg 48 box	51,84 m ² 806,40 kg 48 box	51,84 m ² 806,40 kg 48 box
Mindestabgabereinheit · Min. sales unit	P (box)	P (box)	P (box)	P (box)
Berechnungseinheit · Calculation unit	m ²	m ²	m ²	m ²
Preisgruppe · Price group	P87	P109	P87	P109

SOFT COLOURS Wohnen · Living

				
	30 x 60 cm	30 x 60 cm	30 x 60 cm	30 x 60 cm
Artikelnummer · Article number	1582	1583	1582	1583
Warengruppe · Product group	DS20	DS20	DS30	DS30
Werkmaße · Dimensions (mm)	Grundfliese · Basic tile	Dekor · Decor	Grundfliese · Basic tile	Dekor · Decor
Farbe · Colour	297 x 597 x 9 mm	297 x 597 x 9 mm	297 x 597 x 9 mm	297 x 597 x 9 mm
Oberfläche · Finish	sand	sand	nude	nude
Erzeugnisgruppe	matt Spachteloptik · matt Trowelled look	matt Spachteloptik reliefiert · matt relief	matt Spachteloptik · matt Trowelled look	matt Spachteloptik reliefiert · matt relief
Material	Steingut	Steingut	Steingut	Steingut
Maßeinheit · Unit of measure	Nonvitreous	Nonvitreous	Nonvitreous	Nonvitreous
Pro Paket · Per box	m ² 15,56 kg 5,56 pce	m ² 15,56 kg 5,56 pce	m ² 15,56 kg 5,56 pce	m ² 15,56 kg 5,56 pce
Pro Palette · Per pallet	1,08 m ² 16,80 kg 6 pce	1,08 m ² 16,80 kg 6 pce	1,08 m ² 16,80 kg 6 pce	1,08 m ² 16,80 kg 6 pce
Mindestabgabeneinheit · Min. sales unit	51,84 m ² 806,40 kg 48 box	51,84 m ² 806,40 kg 48 box	51,84 m ² 806,40 kg 48 box	51,84 m ² 806,40 kg 48 box
Berechnungseinheit · Calculation unit	P (box)	P (box)	P (box)	P (box)
Preisgruppe · Price group	m ²	m ²	m ²	m ²
	P87	P109	P87	P109
				
	30 x 60 cm	30 x 60 cm	30 x 60 cm	30 x 60 cm
Artikelnummer · Article number	1582	1583	1582	1583
Warengruppe · Product group	DS50	DS50	DS40	DS40
Werkmaße · Dimensions (mm)	Grundfliese · Basic tile	Dekor · Decor	Grundfliese · Basic tile	Dekor · Decor
Farbe · Colour	297 x 597 x 9 mm	297 x 597 x 9 mm	297 x 597 x 9 mm	297 x 597 x 9 mm
Oberfläche · Finish	jade green	jade green	muted blue	muted blue
Erzeugnisgruppe	matt Spachteloptik · matt Trowelled look	matt Spachteloptik reliefiert · matt relief	matt Spachteloptik · matt Trowelled look	matt Spachteloptik reliefiert · matt relief
Material	Steingut	Steingut	Steingut	Steingut
Maßeinheit · Unit of measure	Nonvitreous	Nonvitreous	Nonvitreous	Nonvitreous
Pro Paket · Per box	m ² 15,56 kg 5,56 pce	m ² 15,56 kg 5,56 pce	m ² 15,56 kg 5,56 pce	m ² 15,56 kg 5,56 pce
Pro Palette · Per pallet	1,08 m ² 16,80 kg 6 pce	1,08 m ² 16,80 kg 6 pce	1,08 m ² 16,80 kg 6 pce	1,08 m ² 16,80 kg 6 pce
Mindestabgabeneinheit · Min. sales unit	51,84 m ² 806,40 kg 48 box	51,84 m ² 806,40 kg 48 box	51,84 m ² 806,40 kg 48 box	51,84 m ² 806,40 kg 48 box
Berechnungseinheit · Calculation unit	P (box)	P (box)	P (box)	P (box)
Preisgruppe · Price group	m ²	m ²	m ²	m ²
	P87	P109	P87	P109

SPARKS *Excellence* by Villeroy & Boch

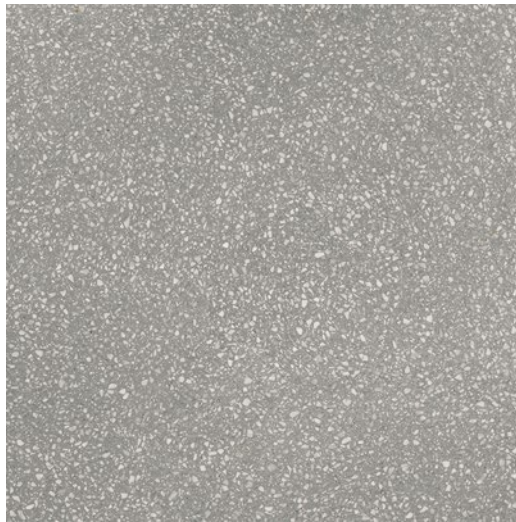

120 x 120 cm
NEW 2023

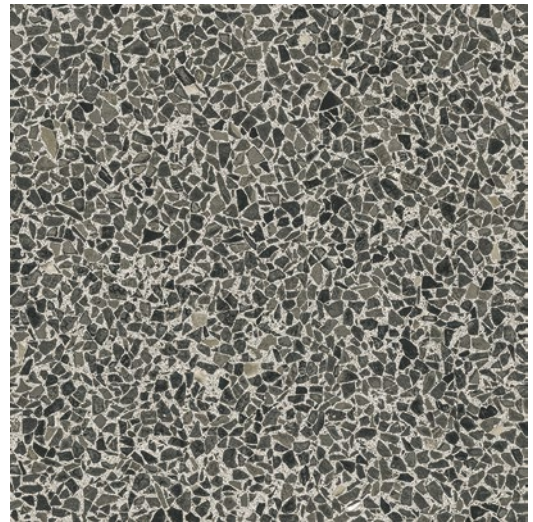

120 x 120 cm
NEW 2023



Artikelnummer · Article number	2757
Warengruppe · Product group	TE60
Werkgröße · Dimensions (mm)	Grundfliese · Basic tile 1197 x 1197 x 9 mm
Farbe · Colour	pearl grey
Oberfläche · Finish	matt Terrazzooptik · matt Terrazzo look
Erzeugnisgruppe	Feinsteinzeug
Material	Porcelain stoneware
Maßeinheit · Unit of measure	m ² 15,96 kg 0,69 pce
Pro Paket · Per box	1,44 m ² 22,98 kg 1 pce
Pro Palette · Per pallet	60,48 m ² 965,16 kg 42 box
Mindestabgabeneinheit · Min. sales unit	P (box)
Berechnungseinheit · Calculation unit	m ²
Preisgruppe · Price group	P139

Artikelnummer · Article number	2757
Warengruppe · Product group	TE61
Werkgröße · Dimensions (mm)	Grundfliese · Basic tile 1197 x 1197 x 9 mm
Farbe · Colour	city grey
Oberfläche · Finish	matt Terrazzooptik · matt Terrazzo look
Erzeugnisgruppe	Feinsteinzeug
Material	Porcelain stoneware
Maßeinheit · Unit of measure	m ² 15,96 kg 0,69 pce
Pro Paket · Per box	1,44 m ² 22,98 kg 1 pce
Pro Palette · Per pallet	60,48 m ² 965,16 kg 42 box
Mindestabgabeneinheit · Min. sales unit	P (box)
Berechnungseinheit · Calculation unit	m ²
Preisgruppe · Price group	P139

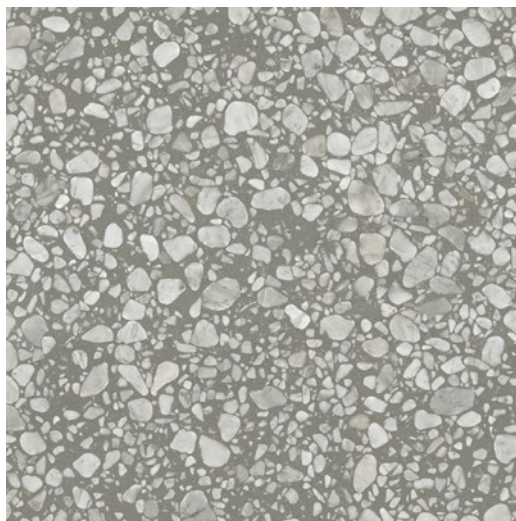

120 x 120 cm
NEW 2023

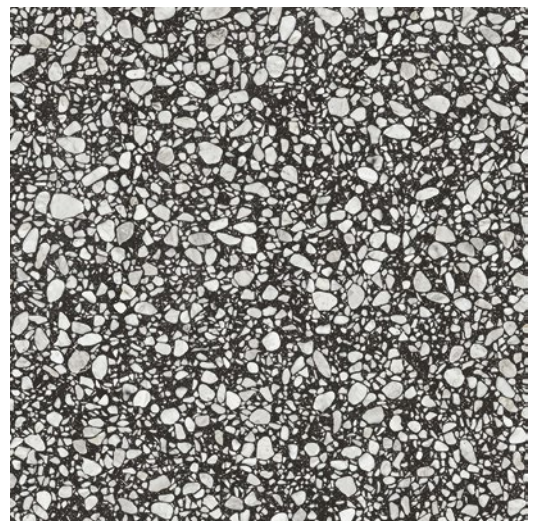

120 x 120 cm
NEW 2023





Artikelnummer · Article number	2757
Warengruppe · Product group	TE70
Werkgröße · Dimensions (mm)	Grundfliese · Basic tile 1197 x 1197 x 9 mm
Farbe · Colour	moon grey
Oberfläche · Finish	matt Terrazzooptik · matt Terrazzo look
Erzeugnisgruppe	Feinsteinzeug
Material	Porcelain stoneware
Maßeinheit · Unit of measure	m ² 15,96 kg 0,69 pce
Pro Paket · Per box	1,44 m ² 22,98 kg 1 pce
Pro Palette · Per pallet	60,48 m ² 965,16 kg 42 box
Mindestabgabeneinheit · Min. sales unit	P (box)
Berechnungseinheit · Calculation unit	m ²
Preisgruppe · Price group	P139

Artikelnummer · Article number	2757
Warengruppe · Product group	TE90
Werkgröße · Dimensions (mm)	Grundfliese · Basic tile 1197 x 1197 x 9 mm
Farbe · Colour	cosmic black
Oberfläche · Finish	matt Terrazzooptik · matt Terrazzo look
Erzeugnisgruppe	Feinsteinzeug
Material	Porcelain stoneware
Maßeinheit · Unit of measure	m ² 15,96 kg 0,69 pce
Pro Paket · Per box	1,44 m ² 22,98 kg 1 pce
Pro Palette · Per pallet	60,48 m ² 965,16 kg 42 box
Mindestabgabeneinheit · Min. sales unit	P (box)
Berechnungseinheit · Calculation unit	m ²
Preisgruppe · Price group	P139

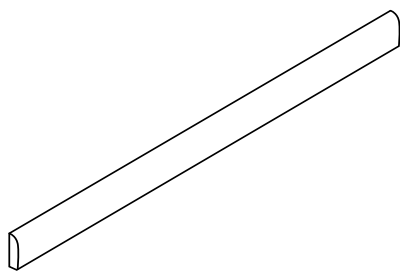
SPARKS *Excellence* by Villeroy & Boch



5 x 120 cm
NEW 2023

Artikelnummer · Article number	2877
	TE60, TE61, TE70 
	TE90 
Warengruppe · Product group	Sockel · Skirting
Werksmaße · Dimensions (mm)	48 x 1197 x 9 mm
Farbe · Colour	-
Oberfläche · Finish	matt Terrazzooptik · matt Terrazzo look VilbostonePlus
Erzeugnisgruppe	Feinsteinzeug
Material	Porcelain stoneware
Maßeinheit · Unit of measure	m 0,76 kg 0,83 pce
Pro Paket · Per box	9,64 m 7,36 kg 1 pce
Pro Palette · Per pallet	616,87 m 471,04 kg 64 box
Mindestabgabereinheit · Min. sales unit	E (pce)
Berechnungseinheit · Calculation unit	Stück · piece
Preisgruppe · Price group	E76

SPOTLIGHT *Excellence* by Villeroy & Boch



reddot design award
winner 2018

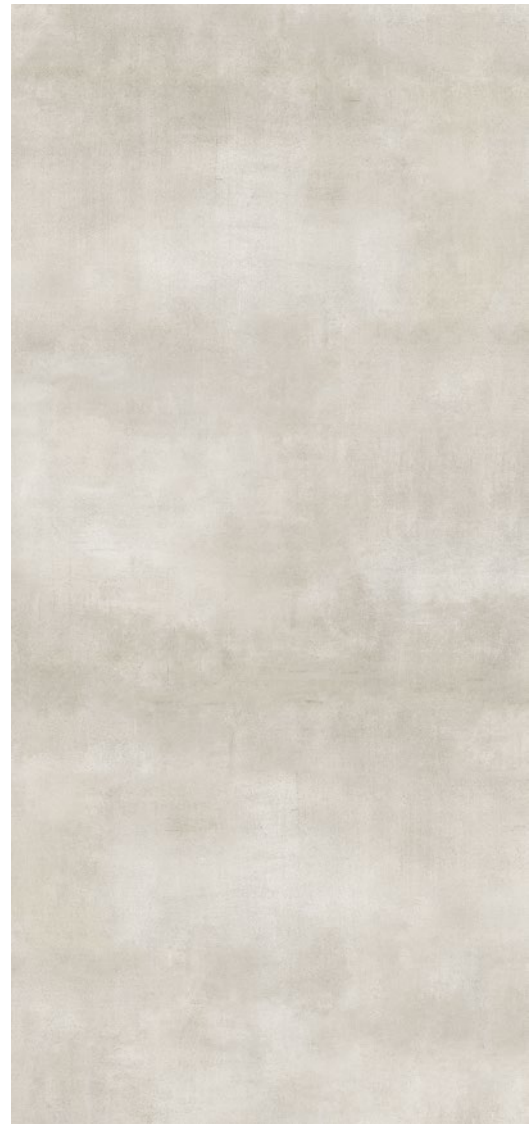
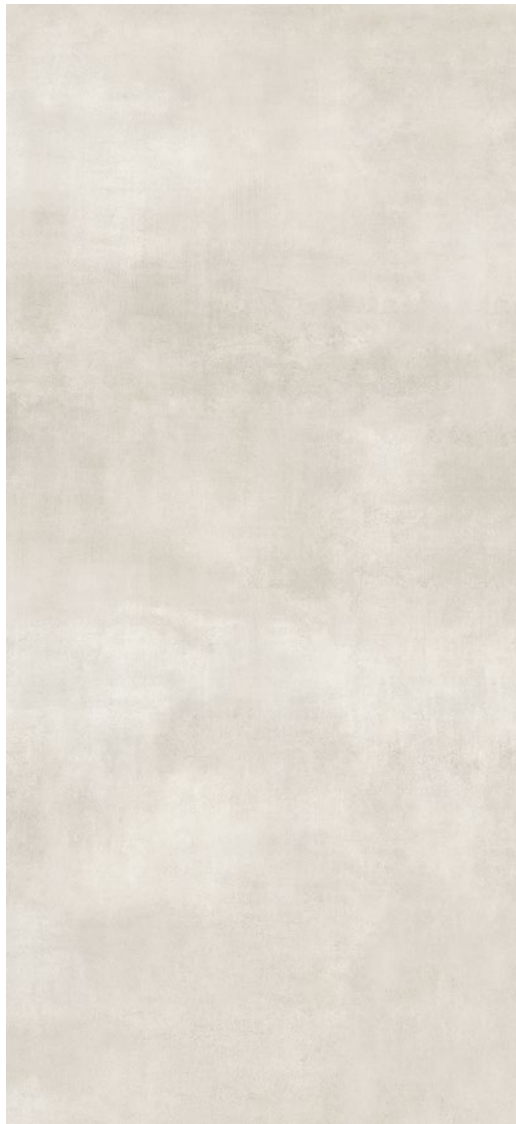

120 x 260 cm



120 x 260 cm



Artikelnummer · Article number	2962	OPTIMA 6 mm	2962	OPTIMA 6 mm
Warengruppe · Product group	CMOM	R9 ◆ *	CM7M	R9 ◆ *
Werksmaße · Dimensions (mm)	Grundfliese · Basic tile		Grundfliese · Basic tile	
Farbe · Colour	1197 x 2600 x 6 mm		1197 x 2600 x 6 mm	
Oberfläche · Finish	white		greige	
Erzeugnisgruppe	matt Dezent schattierte Betonoptik · matt Subtly shaded concrete look		matt Dezent schattierte Betonoptik · matt Subtly shaded concrete look	
Material	VilbostonePlus		VilbostonePlus	
Maßeinheit · Unit of measure	Feinsteinzeug		Feinsteinzeug	
Pro Paket · Per box	Porcelain stoneware		Porcelain stoneware	
Pro Palette · Per pallet	m ² 13,96 kg 0,32 pce		m ² 13,96 kg 0,32 pce	
Mindestabgabereinheit · Min. sales unit	3,12 m ² 43,57 kg 1 pce		3,12 m ² 43,57 kg 1 pce	
Berechnungseinheit · Calculation unit	68,64 m ² 958,54 kg 22 box		68,64 m ² 958,54 kg 22 box	
Preisgruppe · Price group	Stück · piece		Stück · piece	
	m ²		m ²	
	P163		P163	

Für Wandanwendungen empfohlen.
* Nur Längskante rektifiziert
Recommended for wall coverings.
*only the long side of the tiles is rectified.

SPOTLIGHT *Excellence* by Villeroy & Boch



reddot design award
winner 2018



120 x 260 cm



120 x 260 cm



Artikelnummer · Article number	2962	OPTIMA 6 mm	2962	OPTIMA 6 mm
Warengruppe · Product group	CM6M		CM9M	
Werksmaße · Dimensions (mm)	Grundfliese · Basic tile		Grundfliese · Basic tile	
Farbe · Colour	1197 x 2600 x 6 mm		1197 x 2600 x 6 mm	
Oberfläche · Finish	grey		anthracite	
Erzeugnisgruppe	matt Dezent schattierte Betonoptik · matt Subtly shaded concrete look		matt Dezent schattierte Betonoptik · matt Subtly shaded concrete look	
Material	VilbostonePlus		VilbostonePlus	
Maßeinheit · Unit of measure	Feinsteinzeug		Feinsteinzeug	
Pro Paket · Per box	Porcelain stoneware		Porcelain stoneware	
Pro Palette · Per pallet	m ² 13,96 kg 0,32 pce		m ² 13,96 kg 0,32 pce	
Mindestabgabereinheit · Min. sales unit	3,12 m ² 43,57 kg 1 pce		3,12 m ² 43,57 kg 1 pce	
Berechnungseinheit · Calculation unit	68,64 m ² 958,54 kg 22 box		68,64 m ² 958,54 kg 22 box	
Preisgruppe · Price group	Stück · piece		Stück · piece	
	m ²		m ²	
	P163		P163	

Für Wandanwendungen empfohlen.
* Nur Längskante rektifiziert
Recommended for wall coverings.
* only the long side of the tiles is rectified.

SPOTLIGHT *Excellence* by Villeroy & Boch



reddot design award
winner 2018

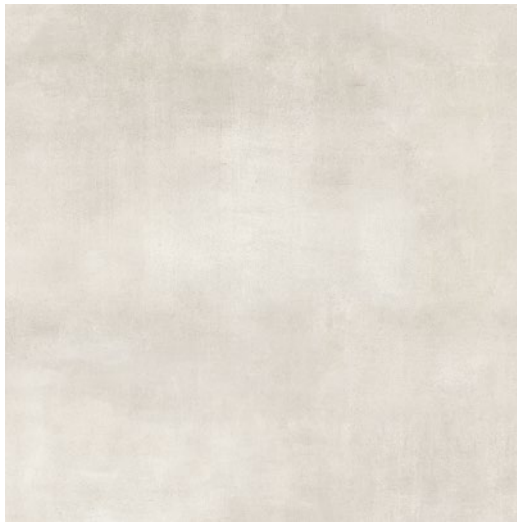

120 x 120 cm



120 x 120 cm



Artikelnummer · Article number	2961	OPTIMA 6 mm
Warengruppe · Product group	CM0M	R9
Werksmaße · Dimensions (mm)	Grundfliese · Basic tile	
Farbe · Colour	1197 x 1197 x 6 mm	
Oberfläche · Finish	white	
Erzeugnisgruppe	matt Dezent schattierte Betonoptik · matt Subtly shaded concrete look	
Material	VilbostonePlus	
Maßeinheit · Unit of measure	Feinsteinzeug	
Pro Paket · Per box	Porcelain stoneware	
Pro Palette · Per pallet	m ² 13,93 kg 0,69 pce	
Mindestabgabereinheit · Min. sales unit	2,88 m ² 40,12 kg 2 pce	
Berechnungseinheit · Calculation unit	72 m ² 1003 kg 25 box	
Preisgruppe · Price group	P (box)	
	m ²	
	P144	

Artikelnummer · Article number	2961	OPTIMA 6 mm
Warengruppe · Product group	CM7M	R9
Werksmaße · Dimensions (mm)	Grundfliese · Basic tile	
Farbe · Colour	1197 x 1197 x 6 mm	
Oberfläche · Finish	greige	
Erzeugnisgruppe	matt Dezent schattierte Betonoptik · matt Subtly shaded concrete look	
Material	VilbostonePlus	
Maßeinheit · Unit of measure	Feinsteinzeug	
Pro Paket · Per box	Porcelain stoneware	
Pro Palette · Per pallet	m ² 13,93 kg 0,69 pce	
Mindestabgabereinheit · Min. sales unit	2,88 m ² 40,12 kg 2 pce	
Berechnungseinheit · Calculation unit	72 m ² 1003 kg 25 box	
Preisgruppe · Price group	P (box)	
	m ²	
	P144	

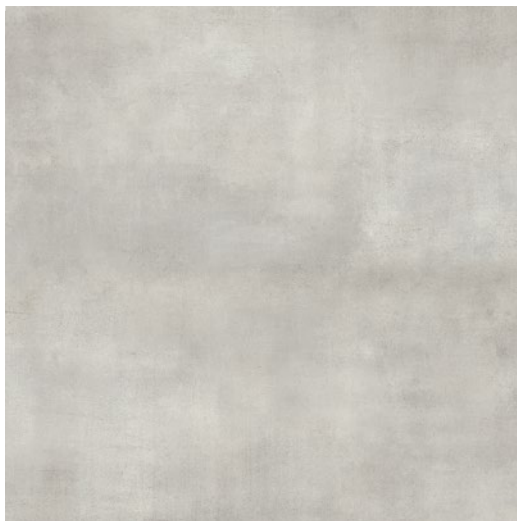

120 x 120 cm



120 x 120 cm



Artikelnummer · Article number	2961	OPTIMA 6 mm
Warengruppe · Product group	CM6M	R9
Werksmaße · Dimensions (mm)	Grundfliese · Basic tile	
Farbe · Colour	1197 x 1197 x 6 mm	
Oberfläche · Finish	grey	
Erzeugnisgruppe	matt Dezent schattierte Betonoptik · matt Subtly shaded concrete look	
Material	VilbostonePlus	
Maßeinheit · Unit of measure	Feinsteinzeug	
Pro Paket · Per box	Porcelain stoneware	
Pro Palette · Per pallet	m ² 13,93 kg 0,69 pce	
Mindestabgabereinheit · Min. sales unit	2,88 m ² 40,12 kg 2 pce	
Berechnungseinheit · Calculation unit	72 m ² 1003 kg 25 box	
Preisgruppe · Price group	P (box)	
	m ²	
	P144	

Artikelnummer · Article number	2961	OPTIMA 6 mm
Warengruppe · Product group	CM9M	R9
Werksmaße · Dimensions (mm)	Grundfliese · Basic tile	
Farbe · Colour	1197 x 1197 x 6 mm	
Oberfläche · Finish	anthracite	
Erzeugnisgruppe	matt Dezent schattierte Betonoptik · matt Subtly shaded concrete look	
Material	VilbostonePlus	
Maßeinheit · Unit of measure	Feinsteinzeug	
Pro Paket · Per box	Porcelain stoneware	
Pro Palette · Per pallet	m ² 13,93 kg 0,69 pce	
Mindestabgabereinheit · Min. sales unit	2,88 m ² 40,12 kg 2 pce	
Berechnungseinheit · Calculation unit	72 m ² 1003 kg 25 box	
Preisgruppe · Price group	P (box)	
	m ²	
	P144	

SPOTLIGHT *Excellence* by Villeroy & Boch



reddot design award
winner 2018

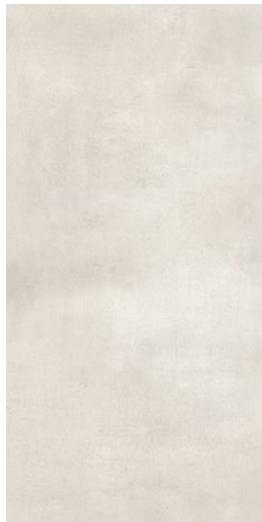

60 x 120 cm



60 x 120 cm



Artikelnummer · Article number	2960	OPTIMA 6 mm
Warengruppe · Product group	CM0M	
Werkgröße · Dimensions (mm)	Grundfliese · Basic tile	
Farbe · Colour	597 x 1197 x 6 mm	
Oberfläche · Finish	white	
Erzeugnisgruppe	matt Dezent schattierte Betonoptik · matt Subtly shaded concrete look	
Material	VilbostonePlus	
Maßeinheit · Unit of measure	Feinsteinzeug	
Pro Paket · Per box	Porcelain stoneware	
Pro Palette · Per pallet	m ² 13,89 kg 1,39 pce	
Mindestabgabereinheit · Min. sales unit	1,44 m ² 20 kg 2 pce	
Berechnungseinheit · Calculation unit	72 m ² 1000 kg 50 box	
Preisgruppe · Price group	P (box)	
	m ²	
	P120	

Artikelnummer · Article number	2960	OPTIMA 6 mm
Warengruppe · Product group	CM7M	
Werkgröße · Dimensions (mm)	Grundfliese · Basic tile	
Farbe · Colour	597 x 1197 x 6 mm	
Oberfläche · Finish	greige	
Erzeugnisgruppe	matt Dezent schattierte Betonoptik · matt Subtly shaded concrete look	
Material	VilbostonePlus	
Maßeinheit · Unit of measure	Feinsteinzeug	
Pro Paket · Per box	Porcelain stoneware	
Pro Palette · Per pallet	m ² 13,89 kg 1,39 pce	
Mindestabgabereinheit · Min. sales unit	1,44 m ² 20 kg 2 pce	
Berechnungseinheit · Calculation unit	72 m ² 1000 kg 50 box	
Preisgruppe · Price group	P (box)	
	m ²	
	P120	



60 x 120 cm



60 x 120 cm



Artikelnummer · Article number	2960	OPTIMA 6 mm
Warengruppe · Product group	CM6M	
Werkgröße · Dimensions (mm)	Grundfliese · Basic tile	
Farbe · Colour	597 x 1197 x 6 mm	
Oberfläche · Finish	grey	
Erzeugnisgruppe	matt Dezent schattierte Betonoptik · matt Subtly shaded concrete look	
Material	VilbostonePlus	
Maßeinheit · Unit of measure	Feinsteinzeug	
Pro Paket · Per box	Porcelain stoneware	
Pro Palette · Per pallet	m ² 13,89 kg 1,39 pce	
Mindestabgabereinheit · Min. sales unit	1,44 m ² 20 kg 2 pce	
Berechnungseinheit · Calculation unit	72 m ² 1000 kg 50 box	
Preisgruppe · Price group	P (box)	
	m ²	
	P120	

Artikelnummer · Article number	2960	OPTIMA 6 mm
Warengruppe · Product group	CM9M	
Werkgröße · Dimensions (mm)	Grundfliese · Basic tile	
Farbe · Colour	597 x 1197 x 6 mm	
Oberfläche · Finish	anthracite	
Erzeugnisgruppe	matt Dezent schattierte Betonoptik · matt Subtly shaded concrete look	
Material	VilbostonePlus	
Maßeinheit · Unit of measure	Feinsteinzeug	
Pro Paket · Per box	Porcelain stoneware	
Pro Palette · Per pallet	m ² 13,89 kg 1,39 pce	
Mindestabgabereinheit · Min. sales unit	1,44 m ² 20 kg 2 pce	
Berechnungseinheit · Calculation unit	72 m ² 1000 kg 50 box	
Preisgruppe · Price group	P (box)	
	m ²	
	P120	

SPOTLIGHT *Excellence* by Villeroy & Boch

Concept³



40 x 120 cm

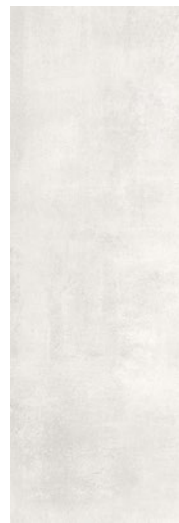

40 x 120 cm

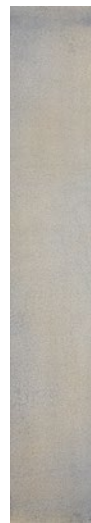

20 x 120 cm



Artikelnummer · Article number
Warengruppe · Product group
Werkmaße · Dimensions (mm)
Farbe · Colour
Oberfläche · Finish
Erzeugnisgruppe
Material
Maßeinheit · Unit of measure
Pro Paket · Per box
Pro Palette · Per pallet
Mindestabgabeneinheit · Min. sales unit
Berechnungseinheit · Calculation unit
Preisgruppe · Price group

1440
CM00
Grundfliese · Basic tile
397 x 1197 x 11 mm
white
matt Dezent schattierte Betonoptik · matt Subtly shaded concrete look
CeramicPlus
Steingut
Nonvitreous
m ² 19,04 kg 2,08 pce
1,44 m ² 27,42 kg 3 pce
25,92 m ² 493,56 kg 18 box
P (box)
m ²
P120

1440
CM60
Grundfliese · Basic tile
397 x 1197 x 11 mm
light grey
matt Dezent schattierte Betonoptik · matt Subtly shaded concrete look
CeramicPlus
Steingut
Nonvitreous
m ² 19,04 kg 2,08 pce
1,44 m ² 27,42 kg 3 pce
25,92 m ² 493,56 kg 18 box
P (box)
m ²
P120

2759
CM30
Bordüre · Border
197 x 1197 x 10 mm
platin · platinum
poliert Metallic-Optik · polished Metallic-Look
Feinsteinzeug glasiert
Glazed porcelain stoneware
m 4,48 kg 0,83 pce
1,21 m 5,40 kg 1 pce
-
E (pce)
Stück · piece
E166

Fliese für Wandanwendungen, nicht für Außen- und Naßbereiche geeignet.
Tile for wall applications, not suitable for outdoor and wet areas.



30 x 60 cm

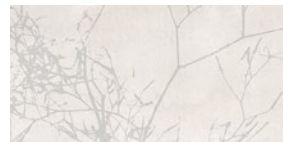

30 x 60 cm

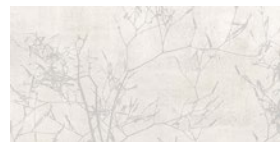

30 x 60 cm

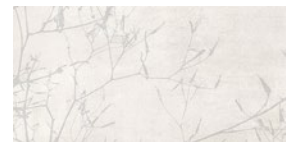

30 x 60 cm



Artikelnummer · Article number
Warengruppe · Product group
Werkmaße · Dimensions (mm)
Farbe · Colour
Oberfläche · Finish
Erzeugnisgruppe
Material
Maßeinheit · Unit of measure
Pro Paket · Per box
Pro Palette · Per pallet
Mindestabgabeneinheit · Min. sales unit
Berechnungseinheit · Calculation unit
Preisgruppe · Price group

1581
CM00
Grundfliese · Basic tile
297 x 597 x 9 mm
white
matt Dezent schattierte Betonoptik · matt Subtly shaded concrete look
CeramicPlus
Steingut
Nonvitreous
m ² 15,56 kg 5,56 pce
1,08 m ² 16,80 kg 6 pce
51,84 m ² 806,40 kg 48 box
P (box)
m ²
P87

























1581
CM01
Dekor · Decor
297 x 597 x 9 mm
white
matt Dezent schattierte Betonoptik reliefiert · matt Subtly shaded concrete look relief
CeramicPlus
Steingut
Nonvitreous
pce 2,80 kg 1 pce
6 pce 16,80 kg 6 pce
288 pce 806,40 kg 48 box
E (pce)
Stück · piece
E73

1581
CM02
Dekor · Decor
297 x 597 x 9 mm
white
matt Dezent schattierte Betonoptik · matt Subtly shaded concrete look
CeramicPlus
Steingut
Nonvitreous
pce 2,80 kg 1 pce
6 pce 16,80 kg 6 pce
288 pce 806,40 kg 48 box
E (pce)
Stück · piece
E73

1581
CM03
Dekor · Decor
297 x 597 x 9 mm
white
matt Dezent schattierte Betonoptik · matt Subtly shaded concrete look
CeramicPlus
Steingut
Nonvitreous
pce 2,80 kg 1 pce
6 pce 16,80 kg 6 pce
288 pce 806,40 kg 48 box
E (pce)
Stück · piece
E73

SPOTLIGHT *Excellence* by Villeroy & Boch

Concept³

				
	30 x 60 cm 	30 x 60 cm 	30 x 60 cm 	30 x 60 cm 
Artikelnummer · Article number	1581	1581	1581	1581
Warengruppe · Product group	CM60  	CM61  	CM62  	CM63  
Werkmaße · Dimensions (mm)	Grundfliese · Basic tile	Dekor · Decor	Dekor · Decor	Dekor · Decor
Farbe · Colour	297 x 597 x 9 mm	297 x 597 x 9 mm	297 x 597 x 9 mm	297 x 597 x 9 mm
Oberfläche · Finish	light grey	light grey	light grey	light grey
Erzeugnisgruppe	matt Dezent schattierte Betonoptik · matt Subtly shaded concrete look	matt Dezent schattierte Betonoptik · matt Subtly shaded concrete look	matt Dezent schattierte Betonoptik · matt Subtly shaded concrete look	matt Dezent schattierte Betonoptik · matt Subtly shaded concrete look
Material	CeramicPlus	CeramicPlus	CeramicPlus	CeramicPlus
Maßeinheit · Unit of measure	Steingut	Steingut	Steingut	Steingut
Pro Paket · Per box	Nonvitreous	Nonvitreous	Nonvitreous	Nonvitreous
Pro Palette · Per pallet	m ² 15,56 kg 5,56 pce	pce 2,80 kg 1 pce	pce 2,80 kg 1 pce	pce 2,80 kg 1 pce
Mindestabgabeneinheit · Min. sales unit	1,08 m ² 16,80 kg 6 pce	6 pce 16,80 kg 6 pce	6 pce 16,80 kg 6 pce	6 pce 16,80 kg 6 pce
Berechnungseinheit · Calculation unit	51,84 m ² 806,40 kg 48 box	288 pce 806,40 kg 48 box	288 pce 806,40 kg 48 box	288 pce 806,40 kg 48 box
Preisgruppe · Price group	P (box)	E (pce)	E (pce)	E (pce)
	m ²	Stück · piece	Stück · piece	Stück · piece
	P87	E73	E73	E73
				
	80 x 80 cm 	80 x 80 cm 		
Artikelnummer · Article number	2810	2810		
Warengruppe · Product group	CM0M  	CM7M  		
Werkmaße · Dimensions (mm)	Grundfliese · Basic tile	Grundfliese · Basic tile		
Farbe · Colour	797 x 797 x 9 mm	797 x 797 x 9 mm		
Oberfläche · Finish	white	greige		
Erzeugnisgruppe	matt Dezent schattierte Betonoptik · matt Subtly shaded concrete look	matt Dezent schattierte Betonoptik · matt Subtly shaded concrete look		
Material	VilbostonePlus	VilbostonePlus		
Maßeinheit · Unit of measure	Feinsteinzeug	Feinsteinzeug		
Pro Paket · Per box	Porcelain stoneware	Porcelain stoneware		
Pro Palette · Per pallet	m ² 19,06 kg 1,56 pce	m ² 19,06 kg 1,56 pce		
Mindestabgabeneinheit · Min. sales unit	1,28 m ² 24,40 kg 2 pce	1,28 m ² 24,40 kg 2 pce		
Berechnungseinheit · Calculation unit	51,20 m ² 976 kg 40 box	51,20 m ² 976 kg 40 box		
Preisgruppe · Price group	P (box)	P (box)		
	m ²	m ²		
	P110	P110		

SPOTLIGHT *Excellence* by Villeroy & Boch

Concept³



80 x 80 cm



80 x 80 cm



Artikelnummer · Article number
Warengruppe · Product group
Werkmaße · Dimensions (mm)
Farbe · Colour
Oberfläche · Finish
Erzeugnisgruppe
Material
Maßeinheit · Unit of measure
Pro Paket · Per box
Pro Palette · Per pallet
Mindestabgabereinheit · Min. sales unit
Berechnungseinheit · Calculation unit
Preisgruppe · Price group

2810
CM6M
Grundfliese · Basic tile
797 x 797 x 9 mm
grey
matt Dezent schattierte Betonoptik · matt Subtly shaded concrete look
VilbostonePlus
Feinsteinzeug
Porcelain stoneware
m ² 19,06 kg 1,56 pce
1,28 m ² 24,40 kg 2 pce
51,20 m ² 976 kg 40 box
P (box)
m ²
P110

2810
CM9M
Grundfliese · Basic tile
797 x 797 x 9 mm
anthracite
matt Dezent schattierte Betonoptik · matt Subtly shaded concrete look
VilbostonePlus
Feinsteinzeug
Porcelain stoneware
m ² 19,06 kg 1,56 pce
1,28 m ² 24,40 kg 2 pce
51,20 m ² 976 kg 40 box
P (box)
m ²
P110

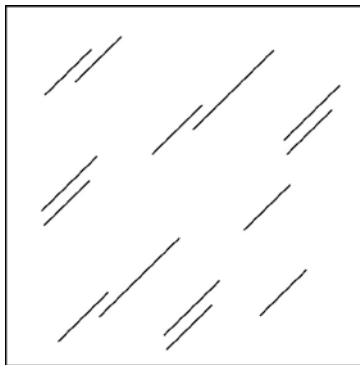

80 x 80 cm



60 x 60 cm



60 x 60 cm

Artikelnummer · Article number
Warengruppe · Product group
Werkmaße · Dimensions (mm)
Farbe · Colour
Oberfläche · Finish
Erzeugnisgruppe
Material
Maßeinheit · Unit of measure
Pro Paket · Per box
Pro Palette · Per pallet
Mindestabgabereinheit · Min. sales unit
Berechnungseinheit · Calculation unit
Preisgruppe · Price group

2810
CM0L, CM6L, CM7L, CM9L
Grundfliese · Basic tile
797 x 797 x 9 mm
-
geläpft/anpoliert Dezent schattierte Betonoptik · rough-polished Subtly shaded concrete look
VilbostonePlus
Feinsteinzeug
Porcelain stoneware
m ² 19,06 kg 1,56 pce
1,28 m ² 24,40 kg 2 pce
51,20 m ² 976 kg 40 box
P (box)
m ²
P120

2660
CM0M
Grundfliese · Basic tile
597 x 597 x 10 mm
white
matt Dezent schattierte Betonoptik · matt Subtly shaded concrete look
VilbostonePlus
Feinsteinzeug
Porcelain stoneware
m ² 21,39 kg 2,78 pce
1,44 m ² 30,80 kg 4 pce
43,20 m ² 924 kg 30 box
P (box)
m ²
P99

2660
CM7M
Grundfliese · Basic tile
597 x 597 x 10 mm
greige
matt Dezent schattierte Betonoptik · matt Subtly shaded concrete look
VilbostonePlus
Feinsteinzeug
Porcelain stoneware
m ² 21,39 kg 2,78 pce
1,44 m ² 30,80 kg 4 pce
43,20 m ² 924 kg 30 box
P (box)
m ²
P99

SPOTLIGHT *Excellence* by Villeroy & Boch

Concept³

	60 x 60 cm	60 x 60 cm	60 x 60 cm	45 x 45 cm
Artikelnummer - Article number	2660	2660	2660	2733
	CM6M	CM9M	CM0L, CM6L, CM7L CM9L	CM0M, CM6M, CM7M CM9M
Warengruppe - Product group	Grundfliese - Basic tile	Grundfliese - Basic tile	Grundfliese - Basic tile	Grundfliese - Basic tile
Werksmaße - Dimensions (mm)	597 x 597 x 10 mm	597 x 597 x 10 mm	597 x 597 x 10 mm	447 x 447 x 9 mm
Farbe - Colour	grey	anthracite	-	-
Oberfläche - Finish	matt Dezent schattierte Betonoptik · matt Subtly shaded concrete look VilbostonePlus	matt Dezent schattierte Betonoptik · matt Subtly shaded concrete look VilbostonePlus	geläpft/anpoliert Dezent schattierte Betonoptik · rough-polished Subtly shaded concrete look VilbostonePlus	matt Dezent schattierte Betonoptik · matt Subtly shaded concrete look VilbostonePlus
Erzeugnisgruppe	Feinsteinzeug	Feinsteinzeug	Feinsteinzeug	Feinsteinzeug
Material	Porcelain stoneware	Porcelain stoneware	Porcelain stoneware	Porcelain stoneware
Maßeinheit - Unit of measure	m ² 21,39 kg 2,78 pce	m ² 21,39 kg 2,78 pce	m ² 21,39 kg 2,78 pce	m ² 20 kg 4,94 pce
Pro Paket - Per box	1,44 m ² 30,80 kg 4 pce	1,44 m ² 30,80 kg 4 pce	1,44 m ² 30,80 kg 4 pce	1,42 m ² 28,35 kg 7 pce
Pro Palette - Per pallet	43,20 m ² 924 kg 30 box	43,20 m ² 924 kg 30 box	43,20 m ² 924 kg 30 box	36,86 m ² 737,10 kg 26 box
Mindestabgabeneinheit - Min. sales unit	P (box)	P (box)	P (box)	P (box)
Berechnungseinheit - Calculation unit	m ²	m ²	m ²	m ²
Preisgruppe - Price group	P99	P99	P110	P67
	30 x 60 cm	30 x 60 cm	30 x 60 cm	30 x 60 cm
Artikelnummer - Article number	2394	2394	2394	2394
	CM0M	CM7M	CM6M	CM9M
Warengruppe - Product group	Grundfliese - Basic tile	Grundfliese - Basic tile	Grundfliese - Basic tile	Grundfliese - Basic tile
Werksmaße - Dimensions (mm)	297 x 597 x 10 mm	297 x 597 x 10 mm	297 x 597 x 10 mm	297 x 597 x 10 mm
Farbe - Colour	white	greige	grey	anthracite
Oberfläche - Finish	matt Dezent schattierte Betonoptik · matt Subtly shaded concrete look VilbostonePlus	matt Dezent schattierte Betonoptik · matt Subtly shaded concrete look VilbostonePlus	matt Dezent schattierte Betonoptik · matt Subtly shaded concrete look VilbostonePlus	matt Dezent schattierte Betonoptik · matt Subtly shaded concrete look VilbostonePlus
Erzeugnisgruppe	Feinsteinzeug	Feinsteinzeug	Feinsteinzeug	Feinsteinzeug
Material	Porcelain stoneware	Porcelain stoneware	Porcelain stoneware	Porcelain stoneware
Maßeinheit - Unit of measure	m ² 21,67 kg 5,56 pce	m ² 21,67 kg 5,56 pce	m ² 21,67 kg 5,56 pce	m ² 21,67 kg 5,56 pce
Pro Paket - Per box	1,08 m ² 23,40 kg 6 pce	1,08 m ² 23,40 kg 6 pce	1,08 m ² 23,40 kg 6 pce	1,08 m ² 23,40 kg 6 pce
Pro Palette - Per pallet	43,20 m ² 936 kg 40 box	43,20 m ² 936 kg 40 box	43,20 m ² 936 kg 40 box	43,20 m ² 936 kg 40 box
Mindestabgabeneinheit - Min. sales unit	P (box)	P (box)	P (box)	P (box)
Berechnungseinheit - Calculation unit	m ²	m ²	m ²	m ²
Preisgruppe - Price group	P87	P87	P87	P87

SPOTLIGHT *Excellence* by Villeroy & Boch

Concept³

2,5 x 15 cm	2,5 x 15 cm	2,5 x 15 cm	2,5 x 15 cm
□ 0,09 m ² 298 x 298 mm	□ 0,09 m ² 298 x 298 mm	□ 0,09 m ² 298 x 298 mm	□ 0,09 m ² 298 x 298 mm
2919	2919	2919	2919
CM75	CM65	CM95	CM05
Grundfliese · Basic tile	Grundfliese · Basic tile	Grundfliese · Basic tile	Grundfliese · Basic tile
Werkmaße · Dimensions (mm)	23 x 148 x 10 mm	23 x 148 x 10 mm	23 x 148 x 10 mm
Farbe · Colour	greige	anthracite	white
Oberfläche · Finish	matt - anpoliert Dezent schattierte Betonoptik · matt - rough polished Subtly shaded concrete look	matt - anpoliert Dezent schattierte Betonoptik · matt - rough polished Subtly shaded concrete look	matt - anpoliert Dezent schattierte Betonoptik · matt - rough polished Subtly shaded concrete look
Erzeugnisgruppe	VilbostonePlus	VilbostonePlus	VilbostonePlus
Material	Feinsteinzeug	Feinsteinzeug	Feinsteinzeug
Maßeinheit · Unit of measure	Porcelain stoneware	Porcelain stoneware	Porcelain stoneware
Pro Paket · Per box	m ² 22 kg 11 pce	m ² 22 kg 11 pce	m ² 22 kg 11 pce
Pro Palette · Per pallet	1 m ² 22 kg 11 pce	1 m ² 22 kg 11 pce	1 m ² 22 kg 11 pce
Mindestabgabereinheit · Min. sales unit	36 m ² 792 kg 36 box	36 m ² 792 kg 36 box	36 m ² 792 kg 36 box
Berechnungseinheit · Calculation unit	P (box)	P (box)	P (box)
Preisgruppe · Price group	m ²	m ²	m ²
	P187	P187	P187
5 x 5 cm	5 x 5 cm	5 x 5 cm	5 x 5 cm
□ 0,09 m ² 298 x 298 mm	□ 0,09 m ² 298 x 298 mm	□ 0,09 m ² 298 x 298 mm	□ 0,09 m ² 298 x 298 mm
2030	2030	2030	2030
CMOM	CM7M	CM6M	CM9M
Grundfliese · Basic tile	Grundfliese · Basic tile	Grundfliese · Basic tile	Grundfliese · Basic tile
Werkmaße · Dimensions (mm)	48 x 48 x 10 mm	48 x 48 x 10 mm	48 x 48 x 10 mm
Farbe · Colour	white	greige	anthracite
Oberfläche · Finish	matt Dezent schattierte Betonoptik · matt Subtly shaded concrete look	matt Dezent schattierte Betonoptik · matt Subtly shaded concrete look	matt Dezent schattierte Betonoptik · matt Subtly shaded concrete look
Erzeugnisgruppe	VilbostonePlus	VilbostonePlus	VilbostonePlus
Material	Feinsteinzeug	Feinsteinzeug	Feinsteinzeug
Maßeinheit · Unit of measure	Porcelain stoneware	Porcelain stoneware	Porcelain stoneware
Pro Paket · Per box	m ² 20,90 kg 11 pce	m ² 20,90 kg 11 pce	m ² 20,90 kg 11 pce
Pro Palette · Per pallet	1 m ² 20,90 kg 11 pce	1 m ² 20,90 kg 11 pce	1 m ² 20,90 kg 11 pce
Mindestabgabereinheit · Min. sales unit	36 m ² 752,40 kg 36 box	36 m ² 752,40 kg 36 box	36 m ² 752,40 kg 36 box
Berechnungseinheit · Calculation unit	P (box)	P (box)	P (box)
Preisgruppe · Price group	m ²	m ²	m ²
	P187	P187	P187
7,5 x 60 cm	8 x 45 cm		
2872	2717		
CMOM, CM6M, CM7M	CMOM, CM6M, CM7M		
CM9M	CM9M		
Sockel · Skirting	Sockel · Skirting		
Werkmaße · Dimensions (mm)	72 x 597 x 10 mm	80 x 447 x 9 mm	
Farbe · Colour	-	-	
Oberfläche · Finish	matt Dezent schattierte Betonoptik · matt Subtly shaded concrete look	matt Dezent schattierte Betonoptik · matt Subtly shaded concrete look	
Erzeugnisgruppe	VilbostonePlus	VilbostonePlus	
Material	Feinsteinzeug	Feinsteinzeug	
Maßeinheit · Unit of measure	Porcelain stoneware	Porcelain stoneware	
Pro Paket · Per box	m 1,64 kg 1,67 pce	m 2,06 kg 2,22 pce	
Pro Palette · Per pallet	11,98 m 19,60 kg 20 pce	11,26 m 23,25 kg 25 pce	
Mindestabgabereinheit · Min. sales unit	574,85 m 940,80 kg 48 box	540,54 m 1116 kg 48 box	
Berechnungseinheit · Calculation unit	E (pce)	E (pce)	
Preisgruppe · Price group	Stück · piece	Stück · piece	
	E51	E41	

STAGEART Wohnen · Living

30 x 60 cm NEW 2023	30 x 60 cm NEW 2023	30 x 60 cm NEW 2023	30 x 60 cm NEW 2023
1538	1538	1539	1539
SA10	SA60	SA10	SA60
Grundfliese · Basic tile	Grundfliese · Basic tile	Dekor · Decor	Dekor · Decor
297 x 597 x 9 mm	297 x 597 x 9 mm	297 x 597 x 9 mm	297 x 597 x 9 mm
creme	light grey	creme	light grey
matt Naturstein-Betonoptik reliefiert · matt stone-concrete look relief	matt Naturstein-Betonoptik reliefiert · matt stone-concrete look relief	matt Naturstein-Betonoptik reliefiert · matt stone-concrete look relief	matt Naturstein-Betonoptik reliefiert · matt stone-concrete look relief
CeramicPlus	CeramicPlus	CeramicPlus	CeramicPlus
Steingut	Steingut	Steingut	Steingut
Nonvitreous	Nonvitreous	Nonvitreous	Nonvitreous
m ² 15,56 kg 5,56 pce	m ² 15,56 kg 5,56 pce	m ² 15,56 kg 5,56 pce	m ² 15,56 kg 5,56 pce
1,08 m ² 16,80 kg 6 pce	1,08 m ² 16,80 kg 6 pce	1,08 m ² 16,80 kg 6 pce	1,08 m ² 16,80 kg 6 pce
51,84 m ² 806,40 kg 48 box	51,84 m ² 806,40 kg 48 box	51,84 m ² 806,40 kg 48 box	51,84 m ² 806,40 kg 48 box
P (box)	P (box)	P (box)	P (box)
m ²	m ²	m ²	m ²
P87	P87	P99	P99
60 x 60 cm NEW 2023	60 x 60 cm NEW 2023	60 x 60 cm NEW 2023	60 x 60 cm NEW 2023
2670	2670	2670	2670
SA20	SA60	SA61	SA80
Grundfliese · Basic tile	Grundfliese · Basic tile	Grundfliese · Basic tile	Grundfliese · Basic tile
597 x 597 x 9 mm	597 x 597 x 9 mm	597 x 597 x 9 mm	597 x 597 x 9 mm
dust	silver	iron	rust
matt Naturstein-Betonoptik reliefiert · matt stone-concrete look relief	matt Naturstein-Betonoptik reliefiert · matt stone-concrete look relief	matt Naturstein-Betonoptik reliefiert · matt stone-concrete look relief	matt Naturstein-Betonoptik reliefiert · matt stone-concrete look relief
VilbostonePlus	VilbostonePlus	VilbostonePlus	VilbostonePlus
Feinsteinzeug	Feinsteinzeug	Feinsteinzeug	Feinsteinzeug
Porcelain stoneware	Porcelain stoneware	Porcelain stoneware	Porcelain stoneware
m ² 19,72 kg 2,78 pce	m ² 19,72 kg 2,78 pce	m ² 19,72 kg 2,78 pce	m ² 19,72 kg 2,78 pce
1,44 m ² 28,40 kg 4 pce	1,44 m ² 28,40 kg 4 pce	1,44 m ² 28,40 kg 4 pce	1,44 m ² 28,40 kg 4 pce
43,20 m ² 852 kg 30 box	43,20 m ² 852 kg 30 box	43,20 m ² 852 kg 30 box	43,20 m ² 852 kg 30 box
P (box)	P (box)	P (box)	P (box)
m ²	m ²	m ²	m ²
P99	P99	P99	P99
30 x 60 cm NEW 2023	30 x 60 cm NEW 2023	30 x 60 cm NEW 2023	30 x 60 cm NEW 2023
2365	2365	2365	2365
SA20	SA60	SA61	SA80
Grundfliese · Basic tile	Grundfliese · Basic tile	Grundfliese · Basic tile	Grundfliese · Basic tile
297 x 597 x 9 mm	297 x 597 x 9 mm	297 x 597 x 9 mm	297 x 597 x 9 mm
dust	silver	iron	rust
matt Naturstein-Betonoptik reliefiert · matt stone-concrete look relief	matt Naturstein-Betonoptik reliefiert · matt stone-concrete look relief	matt Naturstein-Betonoptik reliefiert · matt stone-concrete look relief	matt Naturstein-Betonoptik reliefiert · matt stone-concrete look relief
VilbostonePlus	VilbostonePlus	VilbostonePlus	VilbostonePlus
Feinsteinzeug	Feinsteinzeug	Feinsteinzeug	Feinsteinzeug
Porcelain stoneware	Porcelain stoneware	Porcelain stoneware	Porcelain stoneware
m ² 22,22 kg 5,56 pce	m ² 22,22 kg 5,56 pce	m ² 22,22 kg 5,56 pce	m ² 22,22 kg 5,56 pce
1,08 m ² 24 kg 6 pce	1,08 m ² 24 kg 6 pce	1,08 m ² 24 kg 6 pce	1,08 m ² 24 kg 6 pce
43,20 m ² 960 kg 40 box	43,20 m ² 960 kg 40 box	43,20 m ² 960 kg 40 box	43,20 m ² 960 kg 40 box
P (box)	P (box)	P (box)	P (box)
m ²	m ²	m ²	m ²
P87	P87	P87	P87

STAGEART Wohnen · Living



7,5 x 7,5 cm
NEW 2023
0,09 m² | 297 x 297 mm

Artikelnummer · Article number	2013
Warengruppe · Product group	SA20
Werksmaße · Dimensions (mm)	Grundfliese · Basic tile
Farbe · Colour	72 x 72 x 9 mm
Oberfläche · Finish	dust
Erzeugnisgruppe	matt Naturstein-Betnoptik reliefiert · matt stone-concrete look relief
Material	VilbostonePlus
Maßeinheit · Unit of measure	Feinsteinzeug
Pro Paket · Per box	Porcelain stoneware
Pro Palette · Per pallet	m ² 20,90 kg 11 pce
Mindestabgabereinheit · Min. sales unit	1 m ² 20,90 kg 11 pce
Berechnungseinheit · Calculation unit	36 m ² 752,40 kg 36 box
Preisgruppe · Price group	P (box)
	m ²
	P165

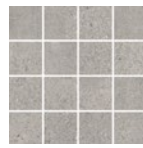

7,5 x 7,5 cm
NEW 2023
0,09 m² | 297 x 297 mm

Artikelnummer · Article number	2013
Warengruppe · Product group	SA60
Werksmaße · Dimensions (mm)	Grundfliese · Basic tile
Farbe · Colour	72 x 72 x 9 mm
Oberfläche · Finish	silver
Erzeugnisgruppe	matt Naturstein-Betnoptik reliefiert · matt stone-concrete look relief
Material	VilbostonePlus
Maßeinheit · Unit of measure	Feinsteinzeug
Pro Paket · Per box	Porcelain stoneware
Pro Palette · Per pallet	m ² 20,90 kg 11 pce
Mindestabgabereinheit · Min. sales unit	1 m ² 20,90 kg 11 pce
Berechnungseinheit · Calculation unit	36 m ² 752,40 kg 36 box
Preisgruppe · Price group	P (box)
	m ²
	P165

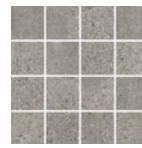

7,5 x 7,5 cm
NEW 2023
0,09 m² | 297 x 297 mm

Artikelnummer · Article number	2013
Warengruppe · Product group	SA61
Werksmaße · Dimensions (mm)	Grundfliese · Basic tile
Farbe · Colour	72 x 72 x 9 mm
Oberfläche · Finish	iron
Erzeugnisgruppe	matt Naturstein-Betnoptik reliefiert · matt stone-concrete look relief
Material	VilbostonePlus
Maßeinheit · Unit of measure	Feinsteinzeug
Pro Paket · Per box	Porcelain stoneware
Pro Palette · Per pallet	m ² 20,90 kg 11 pce
Mindestabgabereinheit · Min. sales unit	1 m ² 20,90 kg 11 pce
Berechnungseinheit · Calculation unit	36 m ² 752,40 kg 36 box
Preisgruppe · Price group	P (box)
	m ²
	P165

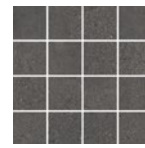

7,5 x 7,5 cm
NEW 2023
0,09 m² | 297 x 297 mm

Artikelnummer · Article number	2013
Warengruppe · Product group	SA80
Werksmaße · Dimensions (mm)	Grundfliese · Basic tile
Farbe · Colour	72 x 72 x 9 mm
Oberfläche · Finish	rust
Erzeugnisgruppe	matt Naturstein-Betnoptik reliefiert · matt stone-concrete look relief
Material	VilbostonePlus
Maßeinheit · Unit of measure	Feinsteinzeug
Pro Paket · Per box	Porcelain stoneware
Pro Palette · Per pallet	m ² 20,90 kg 11 pce
Mindestabgabereinheit · Min. sales unit	1 m ² 20,90 kg 11 pce
Berechnungseinheit · Calculation unit	36 m ² 752,40 kg 36 box
Preisgruppe · Price group	P (box)
	m ²
	P165

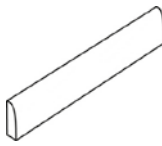

5 x 60 cm
NEW 2023

Artikelnummer · Article number	2875
Warengruppe · Product group	SA20, SA60, SA61
Werksmaße · Dimensions (mm)	SA80
Farbe · Colour	Sockel · Skirting
Oberfläche · Finish	48 x 597 x 9 mm
Erzeugnisgruppe	-
Material	matt Naturstein-Betnoptik · matt stone-concrete look VilbostonePlus
Maßeinheit · Unit of measure	Feinsteinzeug
Pro Paket · Per box	Porcelain stoneware
Pro Palette · Per pallet	m 1,05 kg 1,66 pce
Mindestabgabereinheit · Min. sales unit	9,04 m 9,45 kg 15 pce
Berechnungseinheit · Calculation unit	433,74 m 453,60 kg 48 box
Preisgruppe · Price group	E (pce)
	Stück · piece
	E55

TALK ABOUT Wohnen · Living

	30 x 60 cm
Artikelnummer · Article number	1660
	WE00
Warengruppe · Product group	Grundfliese · Basic tile
Werkmaße · Dimensions (mm)	297 x 597 x 9 mm
Farbe · Colour	weiß · white
Oberfläche · Finish	seidenglanz reliefiert · silky sheen relief CeramicPlus
Erzeugnisgruppe	Steingut
Material	Nonvitreous
Maßeinheit · Unit of measure	m ² 15,56 kg 5,56 pce
Pro Paket · Per box	1,08 m ² 16,80 kg 6 pce
Pro Palette · Per pallet	51,84 m ² 806,40 kg 48 box
Mindestabgabereinheit · Min. sales unit	P (box)
Berechnungseinheit · Calculation unit	m ²
Preisgruppe · Price group	P87
	■ Back Home 2349 BT60, Spotlight 2660 CM7L











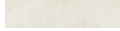

TOWNHOUSE Wohnen · Living



Concept³

	20 x 60 cm	20 x 60 cm	20 x 60 cm
Artikelnummer · Article number	1260	1260	1260
	LC00	LC10	LC60
Warengruppe · Product group	Grundfliese · Basic tile	Grundfliese · Basic tile	Grundfliese · Basic tile
Werkmaße · Dimensions (mm)	197 x 597 x 9 mm	197 x 597 x 9 mm	197 x 597 x 9 mm
Farbe · Colour	weiß · white	beige	grau · grey
Oberfläche · Finish	matt CeramicPlus	matt CeramicPlus	matt CeramicPlus
Erzeugnisgruppe	Steingut	Steingut	Steingut
Material	Nonvitreous	Nonvitreous	Nonvitreous
Maßeinheit · Unit of measure	m ² 15,42 kg 8,33 pce	m ² 15,42 kg 8,33 pce	m ² 15,42 kg 8,33 pce
Pro Paket · Per box	1,08 m ² 16,65 kg 9 pce	1,08 m ² 16,65 kg 9 pce	1,08 m ² 16,65 kg 9 pce
Pro Palette · Per pallet	69,12 m ² 1065,60 kg 64 box	69,12 m ² 1065,60 kg 64 box	69,12 m ² 1065,60 kg 64 box
Mindestabgabereinheit · Min. sales unit	P (box)	P (box)	P (box)
Berechnungseinheit · Calculation unit	m ²	m ²	m ²
Preisgruppe · Price group	P84	P84	P84
	10 x 60 cm	10 x 60 cm	10 x 60 cm
Artikelnummer · Article number	1346	1346	1346
	LC11	LC61	LC91
Warengruppe · Product group	Bordüre · Border	Bordüre · Border	Bordüre · Border
Werkmaße · Dimensions (mm)	97 x 597 x 9 mm	97 x 597 x 9 mm	97 x 597 x 9 mm
Farbe · Colour	beige	grau · grey	anthrazit · anthracite
Oberfläche · Finish	matt	matt	matt
Erzeugnisgruppe	Steingut	Steingut	Steingut
Material	Nonvitreous	Nonvitreous	Nonvitreous
Maßeinheit · Unit of measure	m 1,50 kg 1,67 pce	m 1,50 kg 1,67 pce	m 1,50 kg 1,67 pce
Pro Paket · Per box	7,19 m 10,80 kg 12 pce	7,19 m 10,80 kg 12 pce	7,19 m 10,80 kg 12 pce
Pro Palette · Per pallet	-	-	-
Mindestabgabereinheit · Min. sales unit	E (pce)	E (pce)	E (pce)
Berechnungseinheit · Calculation unit	Stück · piece	Stück · piece	Stück · piece
Preisgruppe · Price group	E81	E81	E81

URBAN ART Wohnen · Living

	 6 x 25 cm NEW 2023	 6 x 25 cm NEW 2023	 6 x 25 cm NEW 2023	 6 x 25 cm NEW 2023
Artikelnummer · Article number	2682	2682	2682	2682
Warengruppe · Product group	UA00	UA20	UA50	UA40
Werkgröße · Dimensions (mm)	Grundfliese · Basic tile 60 x 250 x 8,50 mm	Grundfliese · Basic tile 60 x 250 x 8,50 mm	Grundfliese · Basic tile 60 x 250 x 8,50 mm	Grundfliese · Basic tile 60 x 250 x 8,50 mm
Farbe · Colour	white	mustard	moss green	cobalt
Oberfläche · Finish	glänzend Keramikstruktur · glossy ceramic texture	glänzend Keramikstruktur · glossy ceramic texture	glänzend Keramikstruktur · glossy ceramic texture	glänzend Keramikstruktur · glossy ceramic texture
Erzeugnisgruppe	Feinsteinzeug glasiert	Feinsteinzeug glasiert	Feinsteinzeug glasiert	Feinsteinzeug glasiert
Material	Glazed porcelain stoneware	Glazed porcelain stoneware	Glazed porcelain stoneware	Glazed porcelain stoneware
Maßeinheit · Unit of measure	m ² 18 kg 66,67 pce	m ² 18 kg 66,67 pce	m ² 18 kg 66,67 pce	m ² 18 kg 66,67 pce
Pro Paket · Per box	0,48 m ² 8,64 kg 32 pce	0,48 m ² 8,64 kg 32 pce	0,48 m ² 8,64 kg 32 pce	0,48 m ² 8,64 kg 32 pce
Pro Palette · Per pallet	57,60 m ² 1036,80 kg 120 box	57,60 m ² 1036,80 kg 120 box	57,60 m ² 1036,80 kg 120 box	57,60 m ² 1036,80 kg 120 box
Mindestabgabereinheit · Min. sales unit	P (box)	P (box)	P (box)	P (box)
Berechnungseinheit · Calculation unit	m ²	m ²	m ²	m ²
Preisgruppe · Price group	P120	P120	P120	P120
Nur für die Wand geeignet Suitable for walls only				
	 6 x 25 cm NEW 2023	 6 x 25 cm NEW 2023	 10 x 10 cm NEW 2023	 10 x 10 cm NEW 2023
Artikelnummer · Article number	2682	2682	2190	2190
Warengruppe · Product group	UA30	UA70	UA00	UA20
Werkgröße · Dimensions (mm)	Grundfliese · Basic tile 60 x 250 x 8,50 mm	Grundfliese · Basic tile 65 x 250 x 8,50 mm	Grundfliese · Basic tile 100 x 100 x 8,50 mm	Grundfliese · Basic tile 100 x 100 x 8,50 mm
Farbe · Colour	red	tobacco	white	mustard
Oberfläche · Finish	glänzend Keramikstruktur · glossy ceramic texture	glänzend Keramikstruktur · glossy ceramic texture	glänzend Keramikstruktur · glossy ceramic texture	glänzend Keramikstruktur · glossy ceramic texture
Erzeugnisgruppe	Feinsteinzeug glasiert	Feinsteinzeug glasiert	Feinsteinzeug glasiert	Feinsteinzeug glasiert
Material	Glazed porcelain stoneware	Glazed porcelain stoneware	Glazed porcelain stoneware	Glazed porcelain stoneware
Maßeinheit · Unit of measure	m ² 18 kg 66,67 pce	m ² 18 kg 66,67 pce	m ² 17 kg 100 pce	m ² 17 kg 100 pce
Pro Paket · Per box	0,48 m ² 8,64 kg 32 pce	0,48 m ² 8,64 kg 32 pce	0,54 m ² 9,18 kg 54 pce	0,54 m ² 9,18 kg 54 pce
Pro Palette · Per pallet	57,60 m ² 1036,80 kg 120 box	57,60 m ² 1036,80 kg 120 box	55,08 m ² 936,36 kg 102 box	55,08 m ² 936,36 kg 102 box
Mindestabgabereinheit · Min. sales unit	P (box)	P (box)	P (box)	P (box)
Berechnungseinheit · Calculation unit	m ²	m ²	m ²	m ²
Preisgruppe · Price group	P120	P120	P124	P124
Nur für die Wand geeignet Suitable for walls only				
	 10 x 10 cm NEW 2023	 10 x 10 cm NEW 2023	 10 x 10 cm NEW 2023	 10 x 10 cm NEW 2023
Artikelnummer · Article number	2190	2190	2190	2190
Warengruppe · Product group	UA50	UA40	UA30	UA70
Werkgröße · Dimensions (mm)	Grundfliese · Basic tile 100 x 100 x 8,50 mm	Grundfliese · Basic tile 100 x 100 x 8,50 mm	Grundfliese · Basic tile 100 x 100 x 8,50 mm	Grundfliese · Basic tile 100 x 100 x 8,50 mm
Farbe · Colour	moss green	cobalt	red	tobacco
Oberfläche · Finish	glänzend Keramikstruktur · glossy ceramic texture	glänzend Keramikstruktur · glossy ceramic texture	glänzend Keramikstruktur · glossy ceramic texture	glänzend Keramikstruktur · glossy ceramic texture
Erzeugnisgruppe	Feinsteinzeug glasiert	Feinsteinzeug glasiert	Feinsteinzeug glasiert	Feinsteinzeug glasiert
Material	Glazed porcelain stoneware	Glazed porcelain stoneware	Glazed porcelain stoneware	Glazed porcelain stoneware
Maßeinheit · Unit of measure	m ² 17 kg 100 pce	m ² 17 kg 100 pce	m ² 17 kg 100 pce	m ² 17 kg 100 pce
Pro Paket · Per box	0,54 m ² 9,18 kg 54 pce	0,54 m ² 9,18 kg 54 pce	0,54 m ² 9,18 kg 54 pce	0,54 m ² 9,18 kg 54 pce
Pro Palette · Per pallet	55,08 m ² 936,36 kg 102 box	55,08 m ² 936,36 kg 102 box	55,08 m ² 936,36 kg 102 box	55,08 m ² 936,36 kg 102 box
Mindestabgabereinheit · Min. sales unit	P (box)	P (box)	P (box)	P (box)
Berechnungseinheit · Calculation unit	m ²	m ²	m ²	m ²
Preisgruppe · Price group	P124	P124	P124	P124
Nur für die Wand geeignet Suitable for walls only				

URBAN JUNGLE Wohnen · Living



reddot design award
winner 2018



120 x 260 cm



120 x 260 cm



Artikelnummer · Article number	2962	OPTIMA 6 mm	2962	OPTIMA 6 mm
	TC10		TC70	
Warengruppe · Product group	Grundfliese · Basic tile		Grundfliese · Basic tile	
Werkmaße · Dimensions (mm)	1197 x 2600 x 6 mm		1197 x 2600 x 6 mm	
Farbe · Colour	light grey		greige	
Oberfläche · Finish	matt Betonstruktur · matt concrete texture	VilbostonePlus	matt Betonstruktur · matt concrete texture	VilbostonePlus
Erzeugnisgruppe	Feinsteinzeug		Feinsteinzeug	
Material	Porcelain stoneware		Porcelain stoneware	
Maßeinheit · Unit of measure	m ² 13,96 kg 0,32 pce		m ² 13,96 kg 0,32 pce	
Pro Paket · Per box	3,12 m ² 43,57 kg 1 pce		3,12 m ² 43,57 kg 1 pce	
Pro Palette · Per pallet	68,64 m ² 958,54 kg 22 box		68,64 m ² 958,54 kg 22 box	
Mindestabgabereinheit · Min. sales unit	Stück · piece		Stück · piece	
Berechnungseinheit · Calculation unit	m ²		m ²	
Preisgruppe · Price group	P163		P163	

Für Wandanwendungen empfohlen.
* Nur Längskante rektifiziert
Recommended for wall coverings.
*only the long side of the tiles is rectified.







reddot design award
winner 2018





URBAN JUNGLE Wohnen · Living



120 x 260 cm 

120 x 260 cm 

Artikelnummer · Article number	2962	OPTIMA 6 mm
	TC60	    *
Warengruppe · Product group	Grundfliese · Basic tile	
Werksmaße · Dimensions (mm)	1197 x 2600 x 6 mm	
Farbe · Colour	grey	
Oberfläche · Finish	matt Betonstruktur · matt concrete texture	
Erzeugnisgruppe	Feinsteinzeug	
Material	Porcelain stoneware	
Maßeinheit · Unit of measure	m ² 13,96 kg 0,32 pce	
Pro Paket · Per box	3,12 m ² 43,57 kg 1 pce	
Pro Palette · Per pallet	68,64 m ² 958,54 kg 22 box	
Mindestabgabereinheit · Min. sales unit	Stück · piece	
Berechnungseinheit · Calculation unit	m ²	
Preisgruppe · Price group	P163	

Artikelnummer · Article number	2962	OPTIMA 6 mm
	TC90	    *
Warengruppe · Product group	Grundfliese · Basic tile	
Werksmaße · Dimensions (mm)	1197 x 2600 x 6 mm	
Farbe · Colour	dark grey	
Oberfläche · Finish	matt Betonstruktur · matt concrete texture	
Erzeugnisgruppe	Feinsteinzeug	
Material	Porcelain stoneware	
Maßeinheit · Unit of measure	m ² 13,96 kg 0,32 pce	
Pro Paket · Per box	3,12 m ² 43,57 kg 1 pce	
Pro Palette · Per pallet	68,64 m ² 958,54 kg 22 box	
Mindestabgabereinheit · Min. sales unit	Stück · piece	
Berechnungseinheit · Calculation unit	m ²	
Preisgruppe · Price group	P163	

Für Wändenwendungen empfohlen.
* Nur Längskante rektifiziert
Recommended for wall coverings.
*only the long side of the tiles is rectified.



reddot design award
winner 2018

URBAN JUNGLE Wohnen · Living



120 x 120 cm 2



120 x 120 cm 2

Artikelnummer · Article number
Warengruppe · Product group
Werksmaße · Dimensions (mm)
Farbe · Colour
Oberfläche · Finish
Erzeugnisgruppe
Material
Maßeinheit · Unit of measure
Pro Paket · Per box
Pro Palette · Per pallet
Mindestabgabereinheit · Min. sales unit
Berechnungseinheit · Calculation unit
Preisgruppe · Price group

2961	OPTIMA 6 mm
TC10	
Grundfliese · Basic tile	
1197 x 1197 x 6 mm	
light grey	
matt Betonstruktur · matt concrete texture	VilbostonePlus
Feinsteinzeug	
Porcelain stoneware	
m ² 13,93 kg 0,69 pce	
2,88 m ² 40,12 kg 2 pce	
72 m ² 1003 kg 25 box	
P (box)	
m ²	
P144	

2961	OPTIMA 6 mm
TC70	
Grundfliese · Basic tile	
1197 x 1197 x 6 mm	
greige	
matt Betonstruktur · matt concrete texture	VilbostonePlus
Feinsteinzeug	
Porcelain stoneware	
m ² 13,93 kg 0,69 pce	
2,88 m ² 40,12 kg 2 pce	
72 m ² 1003 kg 25 box	
P (box)	
m ²	
P144	



120 x 120 cm 2



120 x 120 cm 3

Artikelnummer · Article number
Warengruppe · Product group
Werksmaße · Dimensions (mm)
Farbe · Colour
Oberfläche · Finish
Erzeugnisgruppe
Material
Maßeinheit · Unit of measure
Pro Paket · Per box
Pro Palette · Per pallet
Mindestabgabereinheit · Min. sales unit
Berechnungseinheit · Calculation unit
Preisgruppe · Price group

2961	OPTIMA 6 mm
TC60	
Grundfliese · Basic tile	
1197 x 1197 x 6 mm	
grey	
matt Betonstruktur · matt concrete texture	VilbostonePlus
Feinsteinzeug	
Porcelain stoneware	
m ² 13,93 kg 0,69 pce	
2,88 m ² 40,12 kg 2 pce	
72 m ² 1003 kg 25 box	
P (box)	
m ²	
P144	

2961	OPTIMA 6 mm
TC90	
Grundfliese · Basic tile	
1197 x 1197 x 6 mm	
dark grey	
matt Betonstruktur · matt concrete texture	VilbostonePlus
Feinsteinzeug	
Porcelain stoneware	
m ² 13,93 kg 0,69 pce	
2,88 m ² 40,12 kg 2 pce	
72 m ² 1003 kg 25 box	
P (box)	
m ²	
P144	

URBAN JUNGLE Wohnen · Living

Concept³



40 x 120 cm

Artikelnummer · Article number	1440
Warengruppe · Product group	TC00
Werkmaße · Dimensions (mm)	Grundfliese · Basic tile
Farbe · Colour	397 x 1197 x 11 mm
Oberfläche · Finish	white grey
Erzeugnisgruppe	matt Feinkörnige Betonoptik · matt Fine-grained concrete look CeramicPlus
Material	Steingut
Maßeinheit · Unit of measure	Nonvitreous
Pro Paket · Per box	m ² 19,04 kg 2,08 pce
Pro Palette · Per pallet	1,44 m ² 27,42 kg 3 pce
Mindestabgabereinheit · Min. sales unit	25,92 m ² 493,56 kg 18 box
Berechnungseinheit · Calculation unit	P (box)
Preisgruppe · Price group	m ²
	P120



40 x 120 cm

Artikelnummer · Article number	1440
Warengruppe · Product group	TC20
Werkmaße · Dimensions (mm)	Grundfliese · Basic tile
Farbe · Colour	397 x 1197 x 11 mm
Oberfläche · Finish	soft greige
Erzeugnisgruppe	matt Feinkörnige Betonoptik · matt Fine-grained concrete look CeramicPlus
Material	Steingut
Maßeinheit · Unit of measure	Nonvitreous
Pro Paket · Per box	m ² 19,04 kg 2,08 pce
Pro Palette · Per pallet	1,44 m ² 27,42 kg 3 pce
Mindestabgabereinheit · Min. sales unit	25,92 m ² 493,56 kg 18 box
Berechnungseinheit · Calculation unit	P (box)
Preisgruppe · Price group	m ²
	P120



40 x 120 cm

Artikelnummer · Article number	1440
Warengruppe · Product group	TC50
Werkmaße · Dimensions (mm)	Dekor · Decor
Farbe · Colour	397 x 1197 x 11 mm
Oberfläche · Finish	green mix
Erzeugnisgruppe	matt CeramicPlus
Material	Steingut
Maßeinheit · Unit of measure	Nonvitreous
Pro Paket · Per box	m ² 19,04 kg 2,08 pce
Pro Palette · Per pallet	1,44 m ² 27,42 kg 3 pce
Mindestabgabereinheit · Min. sales unit	25,92 m ² 493,56 kg 18 box
Berechnungseinheit · Calculation unit	P (box)
Preisgruppe · Price group	m ²
	P130



40 x 120 cm

Artikelnummer · Article number	1440
Warengruppe · Product group	TC01
Werkmaße · Dimensions (mm)	Dekor · Decor
Farbe · Colour	397 x 1197 x 11 mm
Oberfläche · Finish	white grey jungle
Erzeugnisgruppe	matt Feinkörnige Betonoptik · matt Fine-grained concrete look CeramicPlus
Material	Steingut
Maßeinheit · Unit of measure	Nonvitreous
Pro Paket · Per box	m ² 19,04 kg 2,08 pce
Pro Palette · Per pallet	1,44 m ² 27,42 kg 3 pce
Mindestabgabereinheit · Min. sales unit	25,92 m ² 493,56 kg 18 box
Berechnungseinheit · Calculation unit	P (box)
Preisgruppe · Price group	m ²
	P153

3 Stück im Set
3 piece set



40 x 120 cm

Artikelnummer · Article number	1440
Warengruppe · Product group	TC21
Werkmaße · Dimensions (mm)	Dekor · Decor
Farbe · Colour	397 x 1197 x 11 mm
Oberfläche · Finish	soft greige jungle
Erzeugnisgruppe	matt Feinkörnige Betonoptik · matt Fine-grained concrete look CeramicPlus
Material	Steingut
Maßeinheit · Unit of measure	Nonvitreous
Pro Paket · Per box	m ² 19,04 kg 2,08 pce
Pro Palette · Per pallet	1,44 m ² 27,42 kg 3 pce
Mindestabgabereinheit · Min. sales unit	25,92 m ² 493,56 kg 18 box
Berechnungseinheit · Calculation unit	P (box)
Preisgruppe · Price group	m ²
	P153

3 Stück im Set
3 piece set

URBAN JUNGLE Wohnen · Living

Concept³



40 x 120 cm



40 x 120 cm

Artikelnummer · Article number	1440	1440	1440
Warengruppe · Product group	TC05	TC25	TC25
Werkmaße · Dimensions (mm)	Dekor · Decor	Dekor · Decor	Dekor · Decor
Farbe · Colour	397 x 1197 x 9 mm	397 x 1197 x 9 mm	397 x 1197 x 9 mm
Oberfläche · Finish	wild jungle grey	wild jungle greige	wild jungle greige
Erzeugnisgruppe	matt	matt	matt
Material	CeramicPlus	CeramicPlus	CeramicPlus
Maßeinheit · Unit of measure	Steingut	Steingut	Steingut
Pro Paket · Per box	Nonvitreous	Nonvitreous	Nonvitreous
Pro Palette · Per pallet	m ² 19,04 kg 2,08 pce	m ² 19,04 kg 2,08 pce	m ² 19,04 kg 2,08 pce
Mindestabgabereinheit · Min. sales unit	1,44 m ² 27,42 kg 3 pce	1,44 m ² 27,42 kg 3 pce	1,44 m ² 27,42 kg 3 pce
Berechnungseinheit · Calculation unit	25,92 m ² 493,56 kg 18 box	25,92 m ² 493,56 kg 18 box	25,92 m ² 493,56 kg 18 box
Preisgruppe · Price group	P (box)	P (box)	P (box)
	m ²	m ²	m ²
	P153	P153	P153
	3 Stück im Set 3 piece set	3 Stück im Set 3 piece set	3 Stück im Set 3 piece set
	30 x 60 cm	30 x 60 cm	30 x 60 cm
Artikelnummer · Article number	1581	1581	1581
Warengruppe · Product group	TC00	TC20	TC50
Werkmaße · Dimensions (mm)	Grundfliese · Basic tile	Grundfliese · Basic tile	Dekor · Decor
Farbe · Colour	297 x 597 x 9 mm	297 x 597 x 9 mm	297 x 597 x 9 mm
Oberfläche · Finish	white grey	soft greige	green mix
Erzeugnisgruppe	matt Feinkörnige Betonoptik · matt Fine-grained concrete look CeramicPlus	matt Feinkörnige Betonoptik · matt Fine-grained concrete look CeramicPlus	matt
Material	CeramicPlus	CeramicPlus	CeramicPlus
Maßeinheit · Unit of measure	Steingut	Steingut	Steingut
Pro Paket · Per box	Nonvitreous	Nonvitreous	Nonvitreous
Pro Palette · Per pallet	m ² 15,56 kg 5,56 pce	m ² 15,56 kg 5,56 pce	m ² 15,56 kg 5,56 pce
Mindestabgabereinheit · Min. sales unit	1,08 m ² 16,80 kg 6 pce	1,08 m ² 16,80 kg 6 pce	1,08 m ² 16,80 kg 6 pce
Berechnungseinheit · Calculation unit	51,84 m ² 806,40 kg 48 box	51,84 m ² 806,40 kg 48 box	51,84 m ² 806,40 kg 48 box
Preisgruppe · Price group	P (box)	P (box)	P (box)
	m ²	m ²	m ²
	P94	P94	P124

URBAN JUNGLE Wohnen · Living

Concept³



80 x 80 cm



80 x 80 cm



Artikelnummer · Article number	2810
Warengruppe · Product group	Grundfliese · Basic tile
Werkmaße · Dimensions (mm)	797 x 797 x 9 mm
Farbe · Colour	light grey
Oberfläche · Finish	matt Feinkörnige Betonoptik · matt Fine-grained concrete look VilbostonePlus
Erzeugnisgruppe	Feinsteinzeug
Material	Porcelain stoneware
Maßeinheit · Unit of measure	m ² 19,06 kg 1,56 pce
Pro Paket · Per box	1,28 m ² 24,40 kg 2 pce
Pro Palette · Per pallet	51,20 m ² 976 kg 40 box
Mindestabgabereinheit · Min. sales unit	P (box)
Berechnungseinheit · Calculation unit	m ²
Preisgruppe · Price group	P117

Artikelnummer · Article number	2810
Warengruppe · Product group	Grundfliese · Basic tile
Werkmaße · Dimensions (mm)	797 x 797 x 9 mm
Farbe · Colour	greige
Oberfläche · Finish	matt Feinkörnige Betonoptik · matt Fine-grained concrete look VilbostonePlus
Erzeugnisgruppe	Feinsteinzeug
Material	Porcelain stoneware
Maßeinheit · Unit of measure	m ² 19,06 kg 1,56 pce
Pro Paket · Per box	1,28 m ² 24,40 kg 2 pce
Pro Palette · Per pallet	51,20 m ² 976 kg 40 box
Mindestabgabereinheit · Min. sales unit	P (box)
Berechnungseinheit · Calculation unit	m ²
Preisgruppe · Price group	P117

Auch im Vilbogarden-Sortiment in 20 mm Dicke
Also in 20-mm thicknesses in the Vilbogarden range



80 x 80 cm



80 x 80 cm



Artikelnummer · Article number	2810
Warengruppe · Product group	Grundfliese · Basic tile
Werkmaße · Dimensions (mm)	797 x 797 x 9 mm
Farbe · Colour	grey
Oberfläche · Finish	matt Feinkörnige Betonoptik · matt Fine-grained concrete look VilbostonePlus
Erzeugnisgruppe	Feinsteinzeug
Material	Porcelain stoneware
Maßeinheit · Unit of measure	m ² 19,06 kg 1,56 pce
Pro Paket · Per box	1,28 m ² 24,40 kg 2 pce
Pro Palette · Per pallet	51,20 m ² 976 kg 40 box
Mindestabgabereinheit · Min. sales unit	P (box)
Berechnungseinheit · Calculation unit	m ²
Preisgruppe · Price group	P117

Artikelnummer · Article number	2810
Warengruppe · Product group	Grundfliese · Basic tile
Werkmaße · Dimensions (mm)	797 x 797 x 9 mm
Farbe · Colour	dark grey
Oberfläche · Finish	matt Feinkörnige Betonoptik · matt Fine-grained concrete look VilbostonePlus
Erzeugnisgruppe	Feinsteinzeug
Material	Porcelain stoneware
Maßeinheit · Unit of measure	m ² 19,06 kg 1,56 pce
Pro Paket · Per box	1,28 m ² 24,40 kg 2 pce
Pro Palette · Per pallet	51,20 m ² 976 kg 40 box
Mindestabgabereinheit · Min. sales unit	P (box)
Berechnungseinheit · Calculation unit	m ²
Preisgruppe · Price group	P117

Auch im Vilbogarden-Sortiment in 20 mm Dicke
Also in 20-mm thicknesses in the Vilbogarden range

Auch im Vilbogarden-Sortiment in 20 mm Dicke
Also in 20-mm thicknesses in the Vilbogarden range

URBAN JUNGLE Wohnen · Living

Concept³

	60 x 60 cm	60 x 60 cm	60 x 60 cm	60 x 60 cm
Artikelnummer · Article number	2660	2660	2660	2660
	TC10	TC70	TC60	TC90
Warengruppe · Product group	Grundfliese · Basic tile	Grundfliese · Basic tile	Grundfliese · Basic tile	Grundfliese · Basic tile
Werksmaße · Dimensions (mm)	597 x 597 x 10 mm	597 x 597 x 10 mm	597 x 597 x 10 mm	597 x 597 x 10 mm
Farbe · Colour	light grey	greige	grey	dark grey
Oberfläche · Finish	matt Feinkörnige Betonoptik · matt Fine-grained concrete look	matt Feinkörnige Betonoptik · matt Fine-grained concrete look	matt Feinkörnige Betonoptik · matt Fine-grained concrete look	matt Feinkörnige Betonoptik · matt Fine-grained concrete look
Erzeugnisgruppe	VilbostonePlus	VilbostonePlus	VilbostonePlus	VilbostonePlus
Material	Feinsteinzeug	Feinsteinzeug	Feinsteinzeug	Feinsteinzeug
Maßeinheit · Unit of measure	Porcelain stoneware	Porcelain stoneware	Porcelain stoneware	Porcelain stoneware
Pro Paket · Per box	m ² 22,22 kg 2,78 pce	m ² 22,22 kg 2,78 pce	m ² 22,22 kg 2,78 pce	m ² 22,22 kg 2,78 pce
Pro Palette · Per pallet	1,44 m ² 32 kg 4 pce	1,44 m ² 32 kg 4 pce	1,44 m ² 32 kg 4 pce	1,44 m ² 32 kg 4 pce
Mindestabgabeneinheit · Min. sales unit	43,20 m ² 960 kg 30 box	43,20 m ² 960 kg 30 box	43,20 m ² 960 kg 30 box	43,20 m ² 960 kg 30 box
Berechnungseinheit · Calculation unit	P (box)	P (box)	P (box)	P (box)
Preisgruppe · Price group	m ²	m ²	m ²	m ²
	P99	P99	P99	P99
	45 x 45 cm	30 x 60 cm	30 x 60 cm	30 x 60 cm
Artikelnummer · Article number	2733	2394	2394	2394
	TC10, TC60, TC70	TC10	TC70	TC60
Warengruppe · Product group	Grundfliese · Basic tile	Grundfliese · Basic tile	Grundfliese · Basic tile	Grundfliese · Basic tile
Werksmaße · Dimensions (mm)	447 x 447 x 9 mm	297 x 597 x 10 mm	297 x 597 x 10 mm	297 x 597 x 10 mm
Farbe · Colour	-	light grey	greige	grey
Oberfläche · Finish	matt Feinkörnige Betonoptik · matt Fine-grained concrete look	matt Feinkörnige Betonoptik · matt Fine-grained concrete look	matt Feinkörnige Betonoptik · matt Fine-grained concrete look	matt Feinkörnige Betonoptik · matt Fine-grained concrete look
Erzeugnisgruppe	VilbostonePlus	VilbostonePlus	VilbostonePlus	VilbostonePlus
Material	Feinsteinzeug	Feinsteinzeug	Feinsteinzeug	Feinsteinzeug
Maßeinheit · Unit of measure	Porcelain stoneware	Porcelain stoneware	Porcelain stoneware	Porcelain stoneware
Pro Paket · Per box	m ² 20 kg 4,94 pce	m ² 22,22 kg 5,56 pce	m ² 22,22 kg 5,56 pce	m ² 22,22 kg 5,56 pce
Pro Palette · Per pallet	1,42 m ² 28,35 kg 7 pce	1,08 m ² 24 kg 6 pce	1,08 m ² 24 kg 6 pce	1,08 m ² 24 kg 6 pce
Mindestabgabeneinheit · Min. sales unit	36,86 m ² 737,10 kg 26 box	43,20 m ² 960 kg 40 box	43,20 m ² 960 kg 40 box	43,20 m ² 960 kg 40 box
Berechnungseinheit · Calculation unit	P (box)	P (box)	P (box)	P (box)
Preisgruppe · Price group	m ²	m ²	m ²	m ²
	P67	P87	P87	P87

URBAN JUNGLE Wohnen · Living

Concept³

30 x 60 cm	30 x 60 cm	7,5 x 7,5 cm	7,5 x 7,5 cm
□ 0,18 m ² 298 x 596 mm	□ 0,18 m ² 298 x 596 mm	□ 0,09 m ² 297 x 297 mm	□ 0,09 m ² 297 x 297 mm
2394	2052	2013	2013
TC90	TC99	TC10	TC70
Grundfliese · Basic tile	Dekor · Decor	Grundfliese · Basic tile	Grundfliese · Basic tile
Werkmaße · Dimensions (mm)	298 x 596 x 10 mm	72 x 72 x 10 mm	72 x 72 x 10 mm
Farbe · Colour	multicolour	light grey	greige
Oberfläche · Finish	matt Feinkörnige Betonoptik · matt Fine-grained concrete look	matt Feinkörnige Betonoptik · matt Fine-grained concrete look	matt Feinkörnige Betonoptik · matt Fine-grained concrete look
Erzeugnisgruppe	VilbostonePlus	VilbostonePlus	VilbostonePlus
Material	Feinsteinzeug	Feinsteinzeug	Feinsteinzeug
Maßeinheit · Unit of measure	Porcelain stoneware	Porcelain stoneware	Porcelain stoneware
Pro Paket · Per box	m ² 22,22 kg 5,56 pce	m ² 22 kg 11 pce	m ² 22 kg 11 pce
Pro Palette · Per pallet	1,08 m ² 24 kg 6 pce	0,72 m ² 15,28 kg 4 pce	1 m ² 22 kg 11 pce
Mindestabgabereinheit · Min. sales unit	43,20 m ² 960 kg 40 box	25,92 m ² 550,08 kg 36 box	36 m ² 792 kg 36 box
Berechnungseinheit · Calculation unit	P (box)	P (box)	P (box)
Preisgruppe · Price group	m ²	m ²	m ²
	P87	P182	P178
7,5 x 7,5 cm	7,5 x 7,5 cm	7,5 x 60 cm	8 x 45 cm
□ 0,09 m ² 297 x 297 mm	□ 0,09 m ² 297 x 297 mm		
2013	2013	2872	2717
TC60	TC90	TC10, TC60, TC70 TC90	TC10, TC60, TC70 TC90
Grundfliese · Basic tile	Grundfliese · Basic tile	Sockel · Skirting	Sockel · Skirting
Werkmaße · Dimensions (mm)	72 x 72 x 10 mm	72 x 597 x 10 mm	80 x 449 x 9 mm
Farbe · Colour	grey	-	-
Oberfläche · Finish	matt Feinkörnige Betonoptik · matt Fine-grained concrete look	matt Feinkörnige Betonoptik · matt Fine-grained concrete look	matt Feinkörnige Betonoptik · matt Fine-grained concrete look
Erzeugnisgruppe	VilbostonePlus	VilbostonePlus	VilbostonePlus
Material	Feinsteinzeug	Feinsteinzeug	Feinsteinzeug
Maßeinheit · Unit of measure	Porcelain stoneware	Porcelain stoneware	Porcelain stoneware
Pro Paket · Per box	m ² 22 kg 11 pce	m ² 22 kg 11 pce	m 1,64 kg 1,67 pce
Pro Palette · Per pallet	1 m ² 22 kg 11 pce	1 m ² 22 kg 11 pce	11,98 m 19,60 kg 20 pce
Mindestabgabereinheit · Min. sales unit	36 m ² 792 kg 36 box	36 m ² 792 kg 36 box	574,85 m 940,80 kg 48 box
Berechnungseinheit · Calculation unit	P (box)	P (box)	E (pce)
Preisgruppe · Price group	m ²	m ²	Stück · piece
	P178	E51	E41

URBANTONES *Excellence* by Villeroy & Boch

10 x 30 cm	10 x 30 cm
1670	1670
LI00	LI01
Grundfliese · Basic tile	Grundfliese · Basic tile
Werkmaße · Dimensions (mm)	97 x 297 x 7,50 mm
Farbe · Colour	white
Oberfläche · Finish	matt Unifarbene Glasur reliefiert · matt Plain-coloured glaze relief
Erzeugnisgruppe	CeramicPlus
Material	Steingut
Maßeinheit · Unit of measure	Nonvitreous
Pro Paket · Per box	m ² 14,85 kg 33 pce
Pro Palette · Per pallet	1 m ² 14,85 kg 33 pce
Mindestabgabereinheit · Min. sales unit	66 m ² 980,10 kg 66 box
Berechnungseinheit · Calculation unit	P (box)
Preisgruppe · Price group	m ²
	P110



VICTORIAN *Excellence* by Villeroy & Boch

Concept³



40 x 120 cm



40 x 120 cm



20 x 20 cm

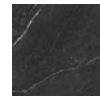

20 x 20 cm

Artikelnummer · Article number	1440
Warengruppe · Product group	MK00
Werkmaße · Dimensions (mm)	Grundfliese · Basic tile
Farbe · Colour	white
Oberfläche · Finish	glänzend Marmorstruktur · glossy marble texture CeramicPlus
Erzeugnisgruppe	Steingut
Material	Nonvitreous
Maßeinheit · Unit of measure	m ² 19,04 kg 2,08 pce
Pro Paket · Per box	1,44 m ² 27,42 kg 3 pce
Pro Palette · Per pallet	25,92 m ² 493,56 kg 18 box
Mindestabgabereinheit · Min. sales unit	P (box)
Berechnungseinheit · Calculation unit	m ²
Preisgruppe · Price group	P122

Artikelnummer · Article number	1440
Warengruppe · Product group	MK90
Werkmaße · Dimensions (mm)	Grundfliese · Basic tile
Farbe · Colour	black
Oberfläche · Finish	glänzend Marmorstruktur · glossy marble texture CeramicPlus
Erzeugnisgruppe	Steingut
Material	Nonvitreous
Maßeinheit · Unit of measure	m ² 19,04 kg 2,08 pce
Pro Paket · Per box	1,44 m ² 27,42 kg 3 pce
Pro Palette · Per pallet	25,92 m ² 493,56 kg 18 box
Mindestabgabereinheit · Min. sales unit	P (box)
Berechnungseinheit · Calculation unit	m ²
Preisgruppe · Price group	P122

Artikelnummer · Article number	1222
Warengruppe · Product group	MK00
Werkmaße · Dimensions (mm)	Grundfliese · Basic tile
Farbe · Colour	white
Oberfläche · Finish	glänzend Marmorstruktur · glossy marble texture CeramicPlus
Erzeugnisgruppe	Steingut
Material	Nonvitreous
Maßeinheit · Unit of measure	m ² 16,75 kg 25 pce
Pro Paket · Per box	0,80 m ² 13,40 kg 20 pce
Pro Palette · Per pallet	48 m ² 804 kg 60 box
Mindestabgabereinheit · Min. sales unit	P (box)
Berechnungseinheit · Calculation unit	m ²
Preisgruppe · Price group	P117

Artikelnummer · Article number	1222
Warengruppe · Product group	MK90
Werkmaße · Dimensions (mm)	Grundfliese · Basic tile
Farbe · Colour	black
Oberfläche · Finish	glänzend Marmorstruktur · glossy marble texture CeramicPlus
Erzeugnisgruppe	Steingut
Material	Nonvitreous
Maßeinheit · Unit of measure	m ² 16,75 kg 25 pce
Pro Paket · Per box	0,80 m ² 13,40 kg 20 pce
Pro Palette · Per pallet	48 m ² 804 kg 60 box
Mindestabgabereinheit · Min. sales unit	P (box)
Berechnungseinheit · Calculation unit	m ²
Preisgruppe · Price group	P117



20 x 20 cm



20 x 20 cm



20 x 20 cm

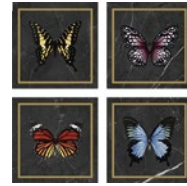

20 x 20 cm

Artikelnummer · Article number	1222
Warengruppe · Product group	MK0A Butterfly
Werkmaße · Dimensions (mm)	Dekor · Decor
Farbe · Colour	white perforated
Oberfläche · Finish	glänzend · glossy
Erzeugnisgruppe	Steingut
Material	Nonvitreous
Maßeinheit · Unit of measure	pce 0,67 kg 1 pce
Pro Paket · Per box	4 pce 2,68 kg 4 pce
Pro Palette · Per pallet	600 pce 402 kg 150 box
Mindestabgabereinheit · Min. sales unit	E (pce)
Berechnungseinheit · Calculation unit	Set
Preisgruppe · Price group	E167

Artikelnummer · Article number	1222
Warengruppe · Product group	MK0E Butterfly
Werkmaße · Dimensions (mm)	Dekor · Decor
Farbe · Colour	white-gold
Oberfläche · Finish	glänzend · glossy
Erzeugnisgruppe	Steingut
Material	Nonvitreous
Maßeinheit · Unit of measure	pce 0,67 kg 1 pce
Pro Paket · Per box	4 pce 2,68 kg 4 pce
Pro Palette · Per pallet	600 pce 402 kg 150 box
Mindestabgabereinheit · Min. sales unit	E (pce)
Berechnungseinheit · Calculation unit	Set
Preisgruppe · Price group	E167

Artikelnummer · Article number	1222
Warengruppe · Product group	MK0C Butterfly
Werkmaße · Dimensions (mm)	Dekor · Decor
Farbe · Colour	black-white
Oberfläche · Finish	glänzend · glossy
Erzeugnisgruppe	Steingut
Material	Nonvitreous
Maßeinheit · Unit of measure	pce 0,67 kg 1 pce
Pro Paket · Per box	4 pce 2,68 kg 4 pce
Pro Palette · Per pallet	600 pce 402 kg 150 box
Mindestabgabereinheit · Min. sales unit	E (pce)
Berechnungseinheit · Calculation unit	Set
Preisgruppe · Price group	E167

Artikelnummer · Article number	1222
Warengruppe · Product group	MK9E Butterfly
Werkmaße · Dimensions (mm)	Dekor · Decor
Farbe · Colour	black-gold
Oberfläche · Finish	glänzend · glossy
Erzeugnisgruppe	Steingut
Material	Nonvitreous
Maßeinheit · Unit of measure	pce 0,67 kg 1 pce
Pro Paket · Per box	4 pce 2,68 kg 4 pce
Pro Palette · Per pallet	600 pce 402 kg 150 box
Mindestabgabereinheit · Min. sales unit	E (pce)
Berechnungseinheit · Calculation unit	Set
Preisgruppe · Price group	E167

4 Stück im Set
4 piece set



VICTORIAN Excellence by Villeroy & Boch

Concept³



20 x 20 cm

Artikelnummer - Article number	1222	Butterfly 45°
Warengruppe - Product group	MK0B	◆
Dekor - Decor	Dekor - Decor	
Werkgröße - Dimensions (mm)	197 x 197 x 10 mm	
Farbe - Colour	white perforated	
Oberfläche - Finish	glänzend · glossy	
Erzeugnisgruppe	Steingut	
Material	Nonvitreous	
Maßeinheit - Unit of measure	pce 0,67 kg 1 pce	
Pro Paket - Per box	4 pce 2,68 kg 4 pce	
Pro Palette - Per pallet	600 pce 402 kg 150 box	
Mindestabgabeneinheit - Min. sales unit	E (pce)	
Berechnungseinheit - Calculation unit	Set	
Preisgruppe - Price group	E167	



20 x 20 cm

Artikelnummer - Article number	1222	Butterfly 45°
Warengruppe - Product group	MK0F	▲◆
Dekor - Decor	Dekor - Decor	
Werkgröße - Dimensions (mm)	197 x 197 x 10 mm	
Farbe - Colour	white-gold	
Oberfläche - Finish	glänzend · glossy	
Erzeugnisgruppe	Steingut	
Material	Nonvitreous	
Maßeinheit - Unit of measure	pce 0,67 kg 1 pce	
Pro Paket - Per box	4 pce 2,68 kg 4 pce	
Pro Palette - Per pallet	600 pce 402 kg 150 box	
Mindestabgabeneinheit - Min. sales unit	E (pce)	
Berechnungseinheit - Calculation unit	Set	
Preisgruppe - Price group	E167	



20 x 20 cm

Artikelnummer - Article number	1222	Butterfly 45°
Warengruppe - Product group	MK0D	▲◆
Dekor - Decor	Dekor - Decor	
Werkgröße - Dimensions (mm)	197 x 197 x 10 mm	
Farbe - Colour	black-white	
Oberfläche - Finish	glänzend · glossy	
Erzeugnisgruppe	Steingut	
Material	Nonvitreous	
Maßeinheit - Unit of measure	pce 0,67 kg 1 pce	
Pro Paket - Per box	4 pce 2,68 kg 4 pce	
Pro Palette - Per pallet	600 pce 402 kg 150 box	
Mindestabgabeneinheit - Min. sales unit	E (pce)	
Berechnungseinheit - Calculation unit	Set	
Preisgruppe - Price group	E167	



20 x 20 cm

Artikelnummer - Article number	1222	Butterfly 45°
Warengruppe - Product group	MK9F	▲◆
Dekor - Decor	Dekor - Decor	
Werkgröße - Dimensions (mm)	197 x 197 x 10 mm	
Farbe - Colour	black-gold	
Oberfläche - Finish	glänzend · glossy	
Erzeugnisgruppe	Steingut	
Material	Nonvitreous	
Maßeinheit - Unit of measure	pce 0,67 kg 1 pce	
Pro Paket - Per box	4 pce 2,68 kg 4 pce	
Pro Palette - Per pallet	600 pce 402 kg 150 box	
Mindestabgabeneinheit - Min. sales unit	E (pce)	
Berechnungseinheit - Calculation unit	Set	
Preisgruppe - Price group	E167	

4 Stück im Set
4 piece set



20 x 20 cm

Artikelnummer - Article number	1222	Single
Warengruppe - Product group	MK0G	◆
Dekor - Decor	Dekor - Decor	
Werkgröße - Dimensions (mm)	197 x 197 x 10 mm	
Farbe - Colour	white perforated	
Oberfläche - Finish	glänzend · glossy	
Erzeugnisgruppe	Steingut	
Material	Nonvitreous	
Maßeinheit - Unit of measure	pce 0,67 kg 1 pce	
Pro Paket - Per box	4 pce 2,68 kg 4 pce	
Pro Palette - Per pallet	600 pce 402 kg 150 box	
Mindestabgabeneinheit - Min. sales unit	E (pce)	
Berechnungseinheit - Calculation unit	Stück · piece	
Preisgruppe - Price group	E81	



20 x 20 cm

Artikelnummer - Article number	1222	Single
Warengruppe - Product group	MK0I	▲◆
Dekor - Decor	Dekor - Decor	
Werkgröße - Dimensions (mm)	197 x 197 x 10 mm	
Farbe - Colour	white-gold	
Oberfläche - Finish	glänzend · glossy	
Erzeugnisgruppe	Steingut	
Material	Nonvitreous	
Maßeinheit - Unit of measure	pce 0,67 kg 1 pce	
Pro Paket - Per box	4 pce 2,68 kg 4 pce	
Pro Palette - Per pallet	600 pce 402 kg 150 box	
Mindestabgabeneinheit - Min. sales unit	E (pce)	
Berechnungseinheit - Calculation unit	Stück · piece	
Preisgruppe - Price group	E92	



20 x 20 cm

Artikelnummer - Article number	1222	Single
Warengruppe - Product group	MK9I	▲◆
Dekor - Decor	Dekor - Decor	
Werkgröße - Dimensions (mm)	197 x 197 x 10 mm	
Farbe - Colour	black-gold	
Oberfläche - Finish	glänzend · glossy	
Erzeugnisgruppe	Steingut	
Material	Nonvitreous	
Maßeinheit - Unit of measure	pce 0,67 kg 1 pce	
Pro Paket - Per box	4 pce 2,68 kg 4 pce	
Pro Palette - Per pallet	600 pce 402 kg 150 box	
Mindestabgabeneinheit - Min. sales unit	E (pce)	
Berechnungseinheit - Calculation unit	Stück · piece	
Preisgruppe - Price group	E92	



20 x 20 cm

Artikelnummer - Article number	1222	Concentric
Warengruppe - Product group	MK0H	◆
Dekor - Decor	Dekor - Decor	
Werkgröße - Dimensions (mm)	197 x 197 x 10 mm	
Farbe - Colour	white perforated	
Oberfläche - Finish	glänzend · glossy	
Erzeugnisgruppe	Steingut	
Material	Nonvitreous	
Maßeinheit - Unit of measure	pce 0,67 kg 1 pce	
Pro Paket - Per box	4 pce 2,68 kg 4 pce	
Pro Palette - Per pallet	600 pce 402 kg 150 box	
Mindestabgabeneinheit - Min. sales unit	E (pce)	
Berechnungseinheit - Calculation unit	Stück · piece	
Preisgruppe - Price group	E81	



20 x 20 cm

Artikelnummer - Article number	1222	Concentric
Warengruppe - Product group	MK0J	▲◆
Dekor - Decor	Dekor - Decor	
Werkgröße - Dimensions (mm)	197 x 197 x 10 mm	
Farbe - Colour	white-gold	
Oberfläche - Finish	glänzend · glossy	
Erzeugnisgruppe	Steingut	
Material	Nonvitreous	
Maßeinheit - Unit of measure	pce 0,67 kg 1 pce	
Pro Paket - Per box	4 pce 2,68 kg 4 pce	
Pro Palette - Per pallet	600 pce 402 kg 150 box	
Mindestabgabeneinheit - Min. sales unit	E (pce)	
Berechnungseinheit - Calculation unit	Stück · piece	
Preisgruppe - Price group	E92	



20 x 20 cm

Artikelnummer - Article number	1222	Concentric
Warengruppe - Product group	MK9J	▲◆
Dekor - Decor	Dekor - Decor	
Werkgröße - Dimensions (mm)	197 x 197 x 10 mm	
Farbe - Colour	black-gold	
Oberfläche - Finish	glänzend · glossy	
Erzeugnisgruppe	Steingut	
Material	Nonvitreous	
Maßeinheit - Unit of measure	pce 0,67 kg 1 pce	
Pro Paket - Per box	4 pce 2,68 kg 4 pce	
Pro Palette - Per pallet	600 pce 402 kg 150 box	
Mindestabgabeneinheit - Min. sales unit	E (pce)	
Berechnungseinheit - Calculation unit	Stück · piece	
Preisgruppe - Price group	E92	



20 x 20 cm

Artikelnummer - Article number	1222	Victorian
Warengruppe - Product group	MK0K	▲◆
Dekor - Decor	Dekor - Decor	
Werkgröße - Dimensions (mm)	197 x 197 x 10 mm	
Farbe - Colour	white	
Oberfläche - Finish	glänzend · glossy	
Erzeugnisgruppe	Steingut	
Material	Nonvitreous	
Maßeinheit - Unit of measure	pce 0,67 kg 1 pce	
Pro Paket - Per box	4 pce 2,68 kg 4 pce	
Pro Palette - Per pallet	600 pce 402 kg 150 box	
Mindestabgabeneinheit - Min. sales unit	E (pce)	
Berechnungseinheit - Calculation unit	Stück · piece	
Preisgruppe - Price group	E92	



20 x 20 cm

Artikelnummer - Article number	1222	Victorian
Warengruppe - Product group	MK9K	▲◆
Dekor - Decor	Dekor - Decor	
Werkgröße - Dimensions (mm)	197 x 197 x 10 mm	
Farbe - Colour	black	
Oberfläche - Finish	glänzend · glossy	
Erzeugnisgruppe	Steingut	
Material	Nonvitreous	
Maßeinheit - Unit of measure	pce 0,67 kg 1 pce	
Pro Paket - Per box	4 pce 2,68 kg 4 pce	
Pro Palette - Per pallet	600 pce 402 kg 150 box	
Mindestabgabeneinheit - Min. sales unit	E (pce)	
Berechnungseinheit - Calculation unit	Stück · piece	
Preisgruppe - Price group	E92	



VICTORIAN *Excellence* by Villeroy & Boch

Concept³



20 x 20 cm

Artikelnummer · Article number	1222	Victorian
Warengruppe · Product group	MKOL	▲◆
Werkgröße · Dimensions (mm)	197 x 197 x 10 mm	
Farbe · Colour	black-white	
Oberfläche · Finish	glänzend · glossy	
Erzeugnisgruppe	Steingut	
Material	Nonvitreous	
Maßeinheit · Unit of measure	pce 0,67 kg 1 pce	
Pro Paket · Per box	4 pce 2,68 kg 4 pce	
Pro Palette · Per pallet	600 pce 402 kg 150 box	
Mindestabgabereinheit · Min. sales unit	E (pce)	
Berechnungseinheit · Calculation unit	Stück · piece	
Preisgruppe · Price group	E92	



20 x 20 cm

Artikelnummer · Article number	1222	Signature
Warengruppe · Product group	MKOM	▲◆
Werkgröße · Dimensions (mm)	197 x 197 x 10 mm	
Farbe · Colour	white	
Oberfläche · Finish	glänzend · glossy	
Erzeugnisgruppe	Steingut	
Material	Nonvitreous	
Maßeinheit · Unit of measure	pce 0,67 kg 1 pce	
Pro Paket · Per box	4 pce 2,68 kg 4 pce	
Pro Palette · Per pallet	600 pce 402 kg 150 box	
Mindestabgabereinheit · Min. sales unit	E (pce)	
Berechnungseinheit · Calculation unit	Stück · piece	
Preisgruppe · Price group	E81	

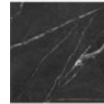

20 x 20 cm

Artikelnummer · Article number	1222	Signature
Warengruppe · Product group	MK9M	▲◆
Werkgröße · Dimensions (mm)	197 x 197 x 10 mm	
Farbe · Colour	black	
Oberfläche · Finish	glänzend · glossy	
Erzeugnisgruppe	Steingut	
Material	Nonvitreous	
Maßeinheit · Unit of measure	pce 0,67 kg 1 pce	
Pro Paket · Per box	4 pce 2,68 kg 4 pce	
Pro Palette · Per pallet	600 pce 402 kg 150 box	
Mindestabgabereinheit · Min. sales unit	E (pce)	
Berechnungseinheit · Calculation unit	Stück · piece	
Preisgruppe · Price group	E81	



12,5 x 40 cm

Artikelnummer · Article number	1427	Butterfly
Warengruppe · Product group	MKB1	▲◆
Werkgröße · Dimensions (mm)	122 x 397 x 10 mm	
Farbe · Colour	gold	
Oberfläche · Finish	glänzend · glossy	
Erzeugnisgruppe	Steingut	
Material	Nonvitreous	
Maßeinheit · Unit of measure	pce 0,84 kg 1 pce	
Pro Paket · Per box	6 pce 5,04 kg 6 pce	
Pro Palette · Per pallet	-	
Mindestabgabereinheit · Min. sales unit	E (pce)	
Berechnungseinheit · Calculation unit	Stück · piece	
Preisgruppe · Price group	E99	



12,5 x 12,5 cm

Artikelnummer · Article number	1428	Butterfly
Warengruppe · Product group	MKE1	▲◆
Werkgröße · Dimensions (mm)	122 x 122 x 10 mm	
Farbe · Colour	gold	
Oberfläche · Finish	glänzend · glossy	
Erzeugnisgruppe	Steingut	
Material	Nonvitreous	
Maßeinheit · Unit of measure	pce 0,26 kg 1 pce	
Pro Paket · Per box	4 pce 1,04 kg 4 pce	
Pro Palette · Per pallet	-	
Mindestabgabereinheit · Min. sales unit	E (pce)	
Berechnungseinheit · Calculation unit	Stück · piece	
Preisgruppe · Price group	E99	



12,5 x 40 cm

Artikelnummer · Article number	1427	Butterfly
Warengruppe · Product group	MKB2	◆
Werkgröße · Dimensions (mm)	122 x 397 x 10 mm	
Farbe · Colour	white	
Oberfläche · Finish	glänzend · glossy	
Erzeugnisgruppe	Steingut	
Material	Nonvitreous	
Maßeinheit · Unit of measure	pce 0,84 kg 1 pce	
Pro Paket · Per box	6 pce 5,04 kg 6 pce	
Pro Palette · Per pallet	-	
Mindestabgabereinheit · Min. sales unit	E (pce)	
Berechnungseinheit · Calculation unit	Stück · piece	
Preisgruppe · Price group	E99	



12,5 x 12,5 cm

Artikelnummer · Article number	1428	Butterfly
Warengruppe · Product group	MKE2	◆
Werkgröße · Dimensions (mm)	122 x 122 x 10 mm	
Farbe · Colour	white	
Oberfläche · Finish	glänzend · glossy	
Erzeugnisgruppe	Steingut	
Material	Nonvitreous	
Maßeinheit · Unit of measure	pce 0,26 kg 1 pce	
Pro Paket · Per box	4 pce 1,04 kg 4 pce	
Pro Palette · Per pallet	-	
Mindestabgabereinheit · Min. sales unit	E (pce)	
Berechnungseinheit · Calculation unit	Stück · piece	
Preisgruppe · Price group	E99	



12,5 x 40 cm

Artikelnummer · Article number	1427	
Warengruppe · Product group	MKB3	▲◆
Werkgröße · Dimensions (mm)	122 x 397 x 10 mm	
Farbe · Colour	gold perforated	
Oberfläche · Finish	glänzend · glossy	
Erzeugnisgruppe	Steingut	
Material	Nonvitreous	
Maßeinheit · Unit of measure	pce 0,84 kg 1 pce	
Pro Paket · Per box	6 pce 5,04 kg 6 pce	
Pro Palette · Per pallet	-	
Mindestabgabereinheit · Min. sales unit	E (pce)	
Berechnungseinheit · Calculation unit	Stück · piece	
Preisgruppe · Price group	E99	



12,5 x 12,5 cm

Artikelnummer · Article number	1428	
Warengruppe · Product group	MKE3	▲◆
Werkgröße · Dimensions (mm)	122 x 122 x 10 mm	
Farbe · Colour	gold perforated	
Oberfläche · Finish	glänzend · glossy	
Erzeugnisgruppe	Steingut	
Material	Nonvitreous	
Maßeinheit · Unit of measure	pce 0,26 kg 1 pce	
Pro Paket · Per box	4 pce 1,04 kg 4 pce	
Pro Palette · Per pallet	-	
Mindestabgabereinheit · Min. sales unit	E (pce)	
Berechnungseinheit · Calculation unit	Stück · piece	
Preisgruppe · Price group	E99	



7,5 x 40 cm

Artikelnummer · Article number	1425	
Warengruppe · Product group	MKB4	▲◆
Werkgröße · Dimensions (mm)	72 x 397 x 10 mm	
Farbe · Colour	diamond	
Oberfläche · Finish	glänzend · glossy	
Erzeugnisgruppe	Steingut	
Material	Nonvitreous	
Maßeinheit · Unit of measure	pce 0,51 kg 1 pce	
Pro Paket · Per box	6 pce 3,06 kg 6 pce	
Pro Palette · Per pallet	-	
Mindestabgabereinheit · Min. sales unit	E (pce)	
Berechnungseinheit · Calculation unit	Stück · piece	
Preisgruppe · Price group	E81	



7,5 x 7,5 cm

Artikelnummer · Article number	1426	
Warengruppe · Product group	MKE4	▲◆
Werkgröße · Dimensions (mm)	72 x 72 x 10 mm	
Farbe · Colour	diamond	
Oberfläche · Finish	glänzend · glossy	
Erzeugnisgruppe	Steingut	
Material	Nonvitreous	
Maßeinheit · Unit of measure	pce 0,10 kg 1 pce	
Pro Paket · Per box	4 pce 0,40 kg 4 pce	
Pro Palette · Per pallet	-	
Mindestabgabereinheit · Min. sales unit	E (pce)	
Berechnungseinheit · Calculation unit	Stück · piece	
Preisgruppe · Price group	E81	



7,5 x 40 cm

Artikelnummer · Article number	1425	
Warengruppe · Product group	MKB5	◆
Werkgröße · Dimensions (mm)	72 x 397 x 10 mm	
Farbe · Colour	white perforated	
Oberfläche · Finish	glänzend · glossy	
Erzeugnisgruppe	Steingut	
Material	Nonvitreous	
Maßeinheit · Unit of measure	pce 0,51 kg 1 pce	
Pro Paket · Per box	6 pce 3,06 kg 6 pce	
Pro Palette · Per pallet	-	
Mindestabgabereinheit · Min. sales unit	E (pce)	
Berechnungseinheit · Calculation unit	Stück · piece	
Preisgruppe · Price group	E81	



7,5 x 7,5 cm

Artikelnummer · Article number	1426	
Warengruppe · Product group	MKE5	◆
Werkgröße · Dimensions (mm)	72 x 72 x 10 mm	
Farbe · Colour	white perforated	
Oberfläche · Finish	glänzend · glossy	
Erzeugnisgruppe	Steingut	
Material	Nonvitreous	
Maßeinheit · Unit of measure	pce 0,10 kg 1 pce	
Pro Paket · Per box	4 pce 0,40 kg 4 pce	
Pro Palette · Per pallet	-	
Mindestabgabereinheit · Min. sales unit	E (pce)	
Berechnungseinheit · Calculation unit	Stück · piece	
Preisgruppe · Price group	E81	



VICTORIAN *Excellence* by Villeroy & Boch

Concept³

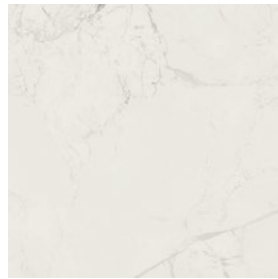

60 x 60 cm

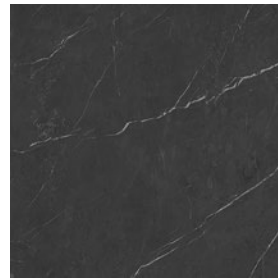

60 x 60 cm



3,7 x 3,7 cm

□ 0,09 m² | 298 x 298 mm

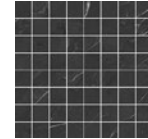

3,7 x 3,7 cm

□ 0,09 m² | 298 x 298 mm

Artikelnummer · Article number	2660	2660	2005	2005
Warengruppe · Product group	MK1P	MK9P	MK1P	MK9P
Werkmaße · Dimensions (mm)	597 x 597 x 9 mm	597 x 597 x 9 mm	35,50 x 35,50 x 9 mm	35,50 x 35,50 x 9 mm
Farbe · Colour	white	black	white	black
Oberfläche · Finish	poliert Marmorstruktur · polished marble texture VilbstonePlus	poliert Marmorstruktur · polished marble texture VilbstonePlus	poliert · polished VilbstonePlus	poliert · polished VilbstonePlus
Erzeugnisgruppe	Feinsteinzeug glasiert	Feinsteinzeug glasiert	Feinsteinzeug glasiert	Feinsteinzeug glasiert
Material	Glazed porcelain stoneware	Glazed porcelain stoneware	Glazed porcelain stoneware	Glazed porcelain stoneware
Maßeinheit · Unit of measure	m ² 22,22 kg 2,78 pce	m ² 22,22 kg 2,78 pce	m ² 22 kg 11 pce	m ² 22 kg 11 pce
Pro Paket · Per box	1,44 m ² 32 kg 4 pce	1,44 m ² 32 kg 4 pce	1 m ² 22 kg 11 pce	1 m ² 22 kg 11 pce
Pro Palette · Per pallet	43,20 m ² 960 kg 30 box	43,20 m ² 960 kg 30 box	36 m ² 792 kg 36 box	36 m ² 792 kg 36 box
Mindestabgabereinheit · Min. sales unit	P (box)	P (box)	P (box)	P (box)
Berechnungseinheit · Calculation unit	m ²	m ²	m ²	m ²
Preisgruppe · Price group	P124	P124	P194	P194

WHITE & CREAM Wohnen Basis · Living Basis

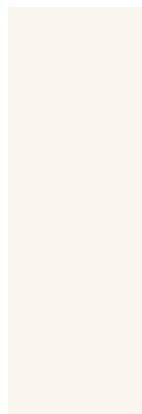

30 x 90 cm

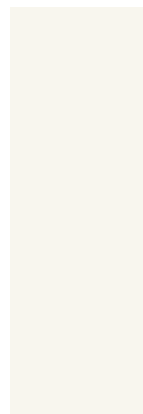

30 x 90 cm

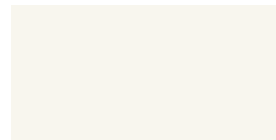

30 x 60 cm

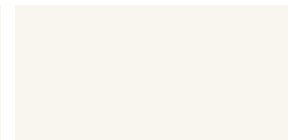



30 x 60 cm

Artikelnummer · Article number	1321	1321	1571	1571
Warengruppe · Product group	SW00	SW01	SW00	SW01
Werkmaße · Dimensions (mm)	300 x 900 x 10 mm	300 x 900 x 10 mm	297 x 597 x 9 mm	297 x 597 x 9 mm
Farbe · Colour	weiß · white	weiß · white	weiß · white	weiß · white
Oberfläche · Finish	matt Unifarbene Glasur · matt Plain-coloured glaze	glänzend Unifarbene Glasur · glossy Plain-coloured glaze	matt Unifarbene Glasur · matt Plain-coloured glaze	glänzend Unifarbene Glasur · glossy Plain-coloured glaze
Erzeugnisgruppe	Steingut	Steingut	Steingut	Steingut
Material	Nonvitreous	Nonvitreous	Nonvitreous	Nonvitreous
Maßeinheit · Unit of measure	m ² 17,41 kg 3,70 pce	m ² 17,41 kg 3,70 pce	m ² 15,56 kg 5,56 pce	m ² 15,56 kg 5,56 pce
Pro Paket · Per box	1,35 m ² 23,50 kg 5 pce	1,35 m ² 23,50 kg 5 pce	1,08 m ² 16,80 kg 6 pce	1,08 m ² 16,80 kg 6 pce
Pro Palette · Per pallet	32,40 m ² 564 kg 24 box	32,40 m ² 564 kg 24 box	51,84 m ² 806,40 kg 48 box	51,84 m ² 806,40 kg 48 box
Mindestabgabereinheit · Min. sales unit	P (box)	P (box)	P (box)	P (box)
Berechnungseinheit · Calculation unit	m ²	m ²	m ²	m ²
Preisgruppe · Price group	P100	P100	P56	P56

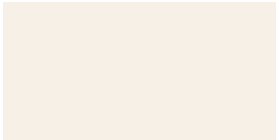
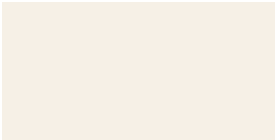
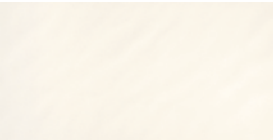
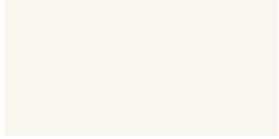
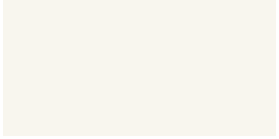
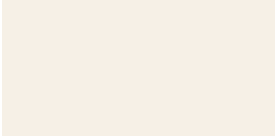
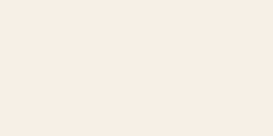
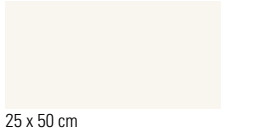
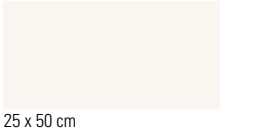
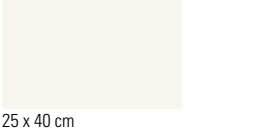
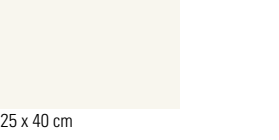
WHITE & CREAM Wohnen Basis · Living Basis











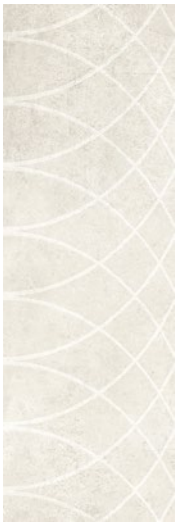
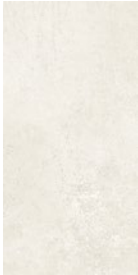
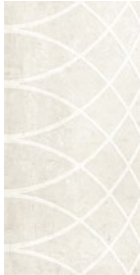

			
30 x 60 cm	30 x 60 cm	30 x 60 cm	30 x 60 cm
1572	1571	1571	1572
SW02	SW10	SW11	SW12
Grundfliese · Basic tile	Grundfliese · Basic tile	Grundfliese · Basic tile	Grundfliese · Basic tile
Werkmaße · Dimensions (mm)	297 x 597 x 9 mm	297 x 597 x 9 mm	297 x 597 x 9 mm
Farbe · Colour	weiß · white	creme	creme
Oberfläche · Finish	reliefiert-glänzend Unifarbene Glasur reliefiert · relief-glossy Plain-coloured glaze relief	matt Unifarbene Glasur · matt Plain-coloured glaze	glänzend Unifarbene Glasur · glossy Plain-coloured glaze
Erzeugnisgruppe	Steingut	Steingut	Steingut
Material	Nonvitreous	Nonvitreous	Nonvitreous
Maßeinheit · Unit of measure	m ² 15,56 kg 5,56 pce	m ² 15,56 kg 5,56 pce	m ² 15,56 kg 5,56 pce
Pro Paket · Per box	1,08 m ² 16,80 kg 6 pce	1,08 m ² 16,80 kg 6 pce	1,08 m ² 16,80 kg 6 pce
Pro Palette · Per pallet	51,84 m ² 806,40 kg 48 box	51,84 m ² 806,40 kg 48 box	51,84 m ² 806,40 kg 48 box
Mindestabgabeneinheit · Min. sales unit	P (box)	P (box)	P (box)
Berechnungseinheit · Calculation unit	m ²	m ²	m ²
Preisgruppe · Price group	P56	P56	P56
			
30 x 60 cm	30 x 60 cm	30 x 60 cm	30 x 60 cm
1586	1586	1586	1586
SW00	SW01	SW10	SW11
Grundfliese · Basic tile	Grundfliese · Basic tile	Grundfliese · Basic tile	Grundfliese · Basic tile
Werkmaße · Dimensions (mm)	297 x 597 x 9 mm	297 x 597 x 9 mm	297 x 597 x 9 mm
Farbe · Colour	weiß · white	creme	creme
Oberfläche · Finish	matt Unifarbene Glasur · matt Plain-coloured glaze	glänzend Unifarbene Glasur · glossy Plain-coloured glaze	matt Unifarbene Glasur · matt Plain-coloured glaze
Erzeugnisgruppe	Steingut	Steingut	Steingut
Material	Nonvitreous	Nonvitreous	Nonvitreous
Maßeinheit · Unit of measure	m ² 15,56 kg 5,56 pce	m ² 15,56 kg 5,56 pce	m ² 15,56 kg 5,56 pce
Pro Paket · Per box	1,08 m ² 16,80 kg 6 pce	1,08 m ² 16,80 kg 6 pce	1,08 m ² 16,80 kg 6 pce
Pro Palette · Per pallet	51,84 m ² 806,40 kg 48 box	51,84 m ² 806,40 kg 48 box	51,84 m ² 806,40 kg 48 box
Mindestabgabeneinheit · Min. sales unit	P (box)	P (box)	P (box)
Berechnungseinheit · Calculation unit	m ²	m ²	m ²
Preisgruppe · Price group	P77	P77	P77
			
25 x 50 cm	25 x 50 cm	25 x 40 cm	25 x 40 cm
1560	1560	1390	1390
SW00	SW01	SW00	SW01
Grundfliese · Basic tile	Grundfliese · Basic tile	Grundfliese · Basic tile	Grundfliese · Basic tile
Werkmaße · Dimensions (mm)	247 x 497 x 7,50 mm	247 x 397 x 8 mm	247 x 397 x 8 mm
Farbe · Colour	weiß · white	weiß · white	weiß · white
Oberfläche · Finish	matt Unifarbene Glasur · matt Plain-coloured glaze	glänzend Unifarbene Glasur · glossy Plain-coloured glaze	matt Unifarbene Glasur · matt Plain-coloured glaze
Erzeugnisgruppe	Steingut	Steingut	Steingut
Material	Nonvitreous	Nonvitreous	Nonvitreous
Maßeinheit · Unit of measure	m ² 13,60 kg 8 pce	m ² 13,60 kg 8 pce	m ² 13,60 kg 10 pce
Pro Paket · Per box	1 m ² 13,60 kg 8 pce	1 m ² 13,60 kg 8 pce	1,10 m ² 14,96 kg 11 pce
Pro Palette · Per pallet	66 m ² 897,60 kg 66 box	66 m ² 897,60 kg 66 box	79,20 m ² 1077,12 kg 72 box
Mindestabgabeneinheit · Min. sales unit	P (box)	P (box)	P (box)
Berechnungseinheit · Calculation unit	m ²	m ²	m ²
Preisgruppe · Price group	P62	P62	P63

WHITE & CREAM Wohnen Basis · Living Basis

	
	25 x 40 cm
Artikelnummer · Article number	1391
	SW02 
Warengruppe · Product group	Grundfliese · Basic tile
Werksmaße · Dimensions (mm)	247 x 397 x 8 mm
Farbe · Colour	weiß · white
Oberfläche · Finish	reliefiert-glänzend Unifarbene Glasur reliefiert · relief-glossy Plain-coloured glaze relief
Erzeugnisgruppe	Steingut
Material	Nonvitreous
Maßeinheit · Unit of measure	m ² 13,60 kg 10 pce
Pro Paket · Per box	1,10 m ² 14,96 kg 11 pce
Pro Palette · Per pallet	79,20 m ² 1077,12 kg 72 box
Mindestabgabereinheit · Min. sales unit	P (box)
Berechnungseinheit · Calculation unit	m ²
Preisgruppe · Price group	P63

WORKSHOP *Excellence* by Villeroy & Boch

Concept³

				
	40 x 120 cm 	40 x 120 cm 	30 x 60 cm 	30 x 60 cm 
Artikelnummer · Article number	1440	1486	1581	1597
	BC00  	BC00  	BC00  	BC00  
Warengruppe · Product group	Grundfliese · Basic tile	Dekor · Decor	Grundfliese · Basic tile	Dekor · Decor
Werksmaße · Dimensions (mm)	397 x 1197 x 11 mm	397 x 1197 x 11 mm	297 x 597 x 9 mm	297 x 597 x 9 mm
Farbe · Colour	light grey	light grey	light grey	light grey
Oberfläche · Finish	matt Abwechslungsreiche Betonstruktur · matt Varied concrete structure CeramicPlus	matt Abwechslungsreiche Betonstruktur · matt Varied concrete structure CeramicPlus	matt Abwechslungsreiche Betonstruktur · matt Varied concrete structure CeramicPlus	matt Abwechslungsreiche Betonstruktur · matt Varied concrete structure CeramicPlus
Erzeugnisgruppe	Steingut	Steingut	Steingut	Steingut
Material	Nonvitreous	Nonvitreous	Nonvitreous	Nonvitreous
Maßeinheit · Unit of measure	m ² 19,04 kg 2,08 pce	m ² 19,04 kg 2,08 pce	m ² 15,56 kg 5,56 pce	m ² 15,56 kg 5,56 pce
Pro Paket · Per box	1,44 m ² 27,42 kg 3 pce	1,44 m ² 27,42 kg 3 pce	1,08 m ² 16,80 kg 6 pce	1,08 m ² 16,80 kg 6 pce
Pro Palette · Per pallet	25,92 m ² 493,56 kg 18 box	25,92 m ² 493,56 kg 18 box	51,84 m ² 806,40 kg 48 box	51,84 m ² 806,40 kg 48 box
Mindestabgabereinheit · Min. sales unit	P (box)	P (box)	P (box)	P (box)
Berechnungseinheit · Calculation unit	m ²	m ²	m ²	m ²
Preisgruppe · Price group	P120	P131	P93	P129

WORKSHOP *Excellence* by Villeroy & Boch

Concept³



60 x 60 cm



30 x 60 cm



30 x 45 cm

□ 0,13 m² | 298 x 448 mm



7,5 x 7,5 cm

□ 0,09 m² | 297 x 297 mm

Artikelnummer · Article number
Warengruppe · Product group
Werkmaße · Dimensions (mm)
Farbe · Colour
Oberfläche · Finish
Erzeugnisgruppe
Material
Maßeinheit · Unit of measure
Pro Paket · Per box
Pro Palette · Per pallet
Mindestabgabeneinheit · Min. sales unit
Berechnungseinheit · Calculation unit
Preisgruppe · Price group

2871
BC30
Grundfliese · Basic tile
597 x 597 x 10 mm
multicolour mix
matt Abwechslungsreiche Betonstruktur · matt Varied concrete structure
VilbostonePlus
Feinsteinzeug
Porcelain stoneware
m ² 22,22 kg 2,78 pce
1,44 m ² 32 kg 4 pce
43,20 m ² 960 kg 30 box
P (box)
m ²
P110

2870
BC30
Grundfliese · Basic tile
297 x 597 x 10 mm
multicolour mix
matt Abwechslungsreiche Betonstruktur · matt Varied concrete structure
VilbostonePlus
Feinsteinzeug
Porcelain stoneware
m ² 22,22 kg 5,56 pce
1,08 m ² 24 kg 6 pce
43,20 m ² 960 kg 40 box
P (box)
m ²
P99

2071
BC30
Dekor · Decor
298 x 448 x 10 mm
multicolour mix
matt Abwechslungsreiche Betonstruktur · matt Varied concrete structure
VilbostonePlus
Feinsteinzeug
Porcelain stoneware
m ² 20,59 kg 7,10 pce
0,85 m ² 17,40 kg 6 pce
33,80 m ² 696 kg 40 box
P (box)
m ²
P179

2013
BC30
Grundfliese · Basic tile
72 x 72 x 10 mm
multicolour mix
matt Abwechslungsreiche Betonstruktur · matt Varied concrete structure
VilbostonePlus
Feinsteinzeug
Porcelain stoneware
m ² 22 kg 11 pce
1 m ² 22 kg 11 pce
36 m ² 792 kg 36 box
P (box)
m ²
P179

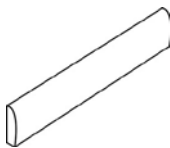

7,5 x 60 cm

Artikelnummer · Article number
Warengruppe · Product group
Werkmaße · Dimensions (mm)
Farbe · Colour
Oberfläche · Finish
Erzeugnisgruppe
Material
Maßeinheit · Unit of measure
Pro Paket · Per box
Pro Palette · Per pallet
Mindestabgabeneinheit · Min. sales unit
Berechnungseinheit · Calculation unit
Preisgruppe · Price group

2872
BC30
Sockel · Skirting
72 x 597 x 10 mm
multicolour mix
matt Abwechslungsreiche Betonstruktur · matt Varied concrete structure
VilbostonePlus
Feinsteinzeug
Porcelain stoneware
m 1,63 kg 1,66 pce
12,05 m 19,60 kg 20 pce
578,31 m 940,80 kg 48 box
E (pce)
Stück · piece
E53

Variationsvielfalt | *Shade variation*

Art. 2871 · 60 x 60 cm
multicolour mix

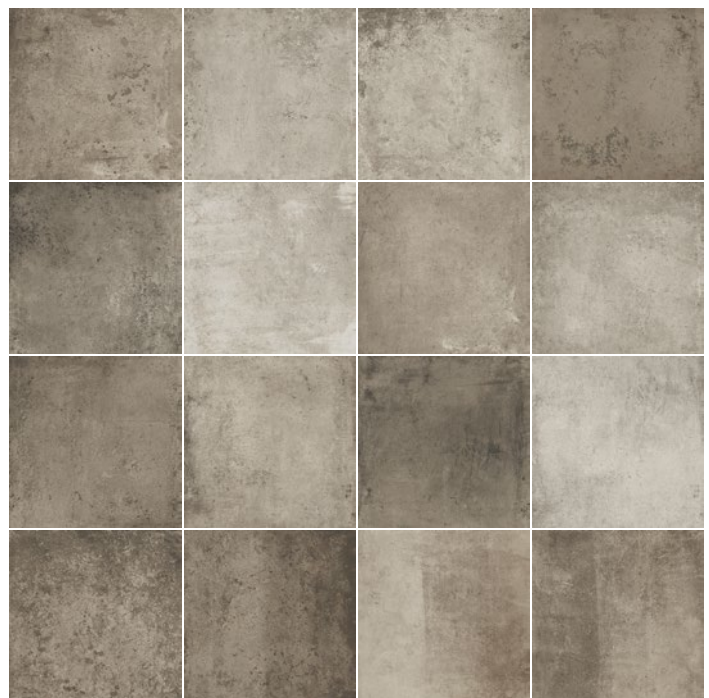

BC30





Fliesen | Tiles: PURE LINE 2.0

Our products for architects and planners are as diverse in scope as the requirements which these professionals face. We offer the ideal tiles for all areas of application, from swimming pools through hotels and restaurants to the industrial, trade and commercial sectors.



Fliesen | Tiles: SOLIDTONES

So vielfältig wie die Anforderungen sind auch unsere Angebote für Architekten und Planer:
Ob im Schwimmbadbau, in Hotels und Restaurants oder für Industrie, Handwerk und Handel – bei uns finden Sie die Fliesen, die in diesen Bereichen optimal zum Einsatz kommen.

Architektur | *Architecture*

ABERDEEN Architektur Design (System) · Architecture Design (System)

Concept³

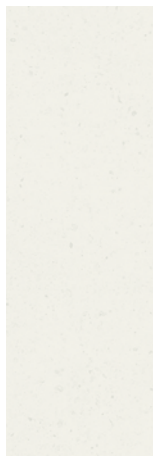

33 x 99 cm

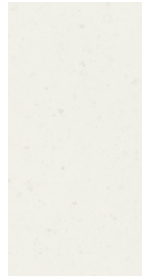

30 x 60 cm

Artikelnummer - Article number	1333	1581
Warengruppe - Product group	SB00	SB00
Werkmaße - Dimensions (mm)	329 x 991 x 9 mm	297 x 597 x 9 mm
Farbe - Colour	white pearl	white pearl
Oberfläche - Finish	matt CeramicPlus	matt CeramicPlus
Erzeugnisgruppe	Steingut	Steingut
Material	Nonvitreous	Nonvitreous
Maßeinheit - Unit of measure	m ² 19,13 kg 3,06 pce	m ² 15,56 kg 5,56 pce
Pro Paket - Per box	1,31 m ² 25 kg 4 pce	1,62 m ² 25,20 kg 9 pce
Pro Palette - Per pallet	36,59 m ² 700 kg 28 box	51,84 m ² 806,40 kg 32 box
Mindestabgabereinheit - Min. sales unit	P (box)	P (box)
Berechnungseinheit - Calculation unit	m ²	m ²
Preisgruppe - Price group	P105	P87



60 x 120 cm



60 x 120 cm

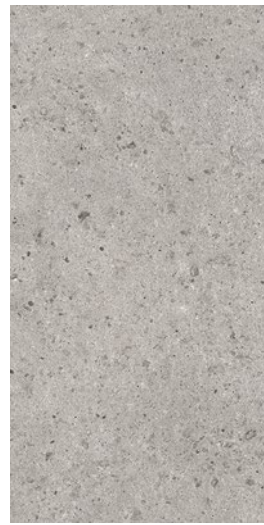

60 x 120 cm



60 x 120 cm

Artikelnummer - Article number	2987	2987	2987	2987
Warengruppe - Product group	SB10	SB70	SB60	SB90
Werkmaße - Dimensions (mm)	597 x 1197 x 10 mm	597 x 1197 x 10 mm	597 x 1197 x 10 mm	597 x 1197 x 10 mm
Farbe - Colour	pearl	tobacco	opal grey	slate grey
Oberfläche - Finish	matt Homogene Granitoptik reliefiert · matt Homogeneous granite look relief	matt Homogene Granitoptik reliefiert · matt Homogeneous granite look relief	matt Homogene Granitoptik reliefiert · matt Homogeneous granite look relief	matt Homogene Granitoptik reliefiert · matt Homogeneous granite look relief
Erzeugnisgruppe	VilbostonePlus	VilbostonePlus	VilbostonePlus	VilbostonePlus
Material	Grès cérame porcelainé Porcellanato	Grès cérame porcelainé Porcellanato	Grès cérame porcelainé Porcellanato	Grès cérame porcelainé Porcellanato
Maßeinheit - Unit of measure	m ² 21,28 kg 1,39 pce	m ² 21,28 kg 1,39 pce	m ² 21,28 kg 1,39 pce	m ² 21,28 kg 1,39 pce
Pro Paket - Per box	1,44 m ² 30,64 kg 2 pce	1,44 m ² 30,64 kg 2 pce	1,44 m ² 30,64 kg 2 pce	1,44 m ² 30,64 kg 2 pce
Pro Palette - Per pallet	43,2 m ² 919,2 kg 30 box	43,2 m ² 919,2 kg 30 box	43,2 m ² 919,2 kg 30 box	43,2 m ² 919,2 kg 30 box
Mindestabgabereinheit - Min. sales unit	P (box)	P (box)	P (box)	P (box)
Berechnungseinheit - Calculation unit	m ²	m ²	m ²	m ²
Preisgruppe - Price group	P110	P110	P110	P110

ABERDEEN Architektur Design (System) · Architecture Design (System)

Concept³



30 x 120 cm



30 x 120 cm



30 x 120 cm

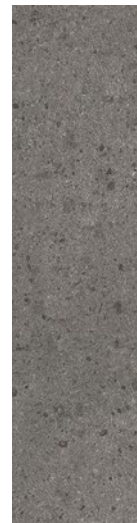

30 x 120 cm



Artikelnummer · Article number	2988	2988	2988	2988
Warengruppe · Product group	SB10	SB70	SB60	SB90
Werksmaße · Dimensions (mm)	Grundfliese · Basic tile 297 x 1197 x 10 mm	Grundfliese · Basic tile 297 x 1197 x 10 mm	Grundfliese · Basic tile 297 x 1197 x 10 mm	Grundfliese · Basic tile 297 x 1197 x 10 mm
Farbe · Colour	pearl	tobacco	opal grey	slate grey
Oberfläche · Finish	matt Homogene Granitoptik reliefiert · matt Homogeneous granite look relief	matt Homogene Granitoptik reliefiert · matt Homogeneous granite look relief	matt Homogene Granitoptik reliefiert · matt Homogeneous granite look relief	matt Homogene Granitoptik reliefiert · matt Homogeneous granite look relief
Erzeugnisgruppe	Feinsteinzeug	Feinsteinzeug	Feinsteinzeug	Feinsteinzeug
Material	Porcelain stoneware	Porcelain stoneware	Porcelain stoneware	Porcelain stoneware
Maßeinheit · Unit of measure	m ² 22,22 kg 2,78 pce	m ² 22,22 kg 2,78 pce	m ² 22,22 kg 2,78 pce	m ² 22,22 kg 2,78 pce
Pro Paket · Per box	1,44 m ² 32 kg 4 pce	1,44 m ² 32 kg 4 pce	1,44 m ² 32 kg 4 pce	1,44 m ² 32 kg 4 pce
Pro Palette · Per pallet	43,20 m ² 960 kg 30 box	43,20 m ² 960 kg 30 box	43,20 m ² 960 kg 30 box	43,20 m ² 960 kg 30 box
Mindestabgabereinheit · Min. sales unit	P (box)	P (box)	P (box)	P (box)
Berechnungseinheit · Calculation unit	m ²	m ²	m ²	m ²
Preisgruppe · Price group	P126	P126	P126	P126

ABERDEEN Architektur Design (System) · Architecture Design (System)

Concept³

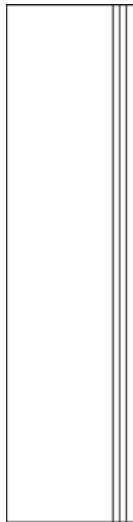

30 x 120 cm

Artikelnummer · Article number	2732
Warengruppe · Product group	Treppenauftritt · Stair tread
Werkmaße · Dimensions (mm)	297 x 1197 x 10 mm
Farbe · Colour	-
Oberfläche · Finish	matt Homogene Granitoptik reliefiert · matt Homogeneous granite look relief VilbostonePlus
Erzeugnisgruppe	Feinsteinzeug
Material	Porcelain stoneware
Maßeinheit · Unit of measure	m 5,89 kg 0,83 pce
Pro Paket · Per box	2,41 m 14,20 kg 2 pce
Pro Palette · Per pallet	106,02 m 624,80 kg 44 box
Mindestabgabereinheit · Min. sales unit	E (pce)
Berechnungseinheit · Calculation unit	Stück · piece
Preisgruppe · Price group	E118

Auftragsbezogene Fertigung der Treppen in der zu bestellten Grundfliese passenden Nuance. Lieferzeit auf Anfrage.
Steps made to order in the nuance that matches the basic tile ordered. Delivery time on request.



60 x 60 cm



60 x 60 cm



60 x 60 cm



60 x 60 cm



Artikelnummer · Article number	2577
Warengruppe · Product group	Grundfliese · Basic tile
Werkmaße · Dimensions (mm)	597 x 597 x 10 mm
Farbe · Colour	pearl
Oberfläche · Finish	matt Homogene Granitoptik reliefiert · matt Homogeneous granite look relief VilbostonePlus
Erzeugnisgruppe	Feinsteinzeug
Material	Porcelain stoneware
Maßeinheit · Unit of measure	m ² 22,22 kg 2,78 pce
Pro Paket · Per box	1,44 m ² 32 kg 4 pce
Pro Palette · Per pallet	43,20 m ² 960 kg 30 box
Mindestabgabereinheit · Min. sales unit	P (box)
Berechnungseinheit · Calculation unit	m ²
Preisgruppe · Price group	P93

Artikelnummer · Article number	2577
Warengruppe · Product group	Grundfliese · Basic tile
Werkmaße · Dimensions (mm)	597 x 597 x 10 mm
Farbe · Colour	tobacco
Oberfläche · Finish	matt Homogene Granitoptik reliefiert · matt Homogeneous granite look relief VilbostonePlus
Erzeugnisgruppe	Feinsteinzeug
Material	Porcelain stoneware
Maßeinheit · Unit of measure	m ² 22,22 kg 2,78 pce
Pro Paket · Per box	1,44 m ² 32 kg 4 pce
Pro Palette · Per pallet	43,20 m ² 960 kg 30 box
Mindestabgabereinheit · Min. sales unit	P (box)
Berechnungseinheit · Calculation unit	m ²
Preisgruppe · Price group	P93

Artikelnummer · Article number	2577
Warengruppe · Product group	Grundfliese · Basic tile
Werkmaße · Dimensions (mm)	597 x 597 x 10 mm
Farbe · Colour	opal grey
Oberfläche · Finish	matt Homogene Granitoptik reliefiert · matt Homogeneous granite look relief VilbostonePlus
Erzeugnisgruppe	Feinsteinzeug
Material	Porcelain stoneware
Maßeinheit · Unit of measure	m ² 22,22 kg 2,78 pce
Pro Paket · Per box	1,44 m ² 32 kg 4 pce
Pro Palette · Per pallet	43,20 m ² 960 kg 30 box
Mindestabgabereinheit · Min. sales unit	P (box)
Berechnungseinheit · Calculation unit	m ²
Preisgruppe · Price group	P93

Artikelnummer · Article number	2577
Warengruppe · Product group	Grundfliese · Basic tile
Werkmaße · Dimensions (mm)	597 x 597 x 10 mm
Farbe · Colour	slate grey
Oberfläche · Finish	matt Homogene Granitoptik reliefiert · matt Homogeneous granite look relief VilbostonePlus
Erzeugnisgruppe	Feinsteinzeug
Material	Porcelain stoneware
Maßeinheit · Unit of measure	m ² 22,22 kg 2,78 pce
Pro Paket · Per box	1,44 m ² 32 kg 4 pce
Pro Palette · Per pallet	43,20 m ² 960 kg 30 box
Mindestabgabereinheit · Min. sales unit	P (box)
Berechnungseinheit · Calculation unit	m ²
Preisgruppe · Price group	P93

ABERDEEN Architektur Design (System) · Architecture Design (System)

Concept³

	30 x 60 cm	30 x 60 cm	30 x 60 cm	30 x 60 cm
Artikelnummer · Article number	2576	2576	2576	2576
Warengruppe · Product group	SB10	SB70	SB60	SB90
Werkmaße · Dimensions (mm)	Grundfliese · Basic tile	Grundfliese · Basic tile	Grundfliese · Basic tile	Grundfliese · Basic tile
Farbe · Colour	297 x 597 x 10 mm	297 x 597 x 10 mm	297 x 597 x 10 mm	297 x 597 x 10 mm
Oberfläche · Finish	pearl	tobacco	opal grey	slate grey
Erzeugnisgruppe	matt Homogene Granitoptik reliefiert · matt Homogeneous granite look relief	matt Homogene Granitoptik reliefiert · matt Homogeneous granite look relief	matt Homogene Granitoptik reliefiert · matt Homogeneous granite look relief	matt Homogene Granitoptik reliefiert · matt Homogeneous granite look relief
Material	VilbostonePlus	VilbostonePlus	VilbostonePlus	VilbostonePlus
Maßeinheit · Unit of measure	Feinsteinzeug	Feinsteinzeug	Feinsteinzeug	Feinsteinzeug
Pro Paket · Per box	Porcelain stoneware	Porcelain stoneware	Porcelain stoneware	Porcelain stoneware
Pro Palette · Per pallet	m ² 22,22 kg 5,56 pce	m ² 22,22 kg 5,56 pce	m ² 22,22 kg 5,56 pce	m ² 22,22 kg 5,56 pce
Mindestabgabeneinheit · Min. sales unit	1,08 m ² 24 kg 6 pce	1,08 m ² 24 kg 6 pce	1,08 m ² 24 kg 6 pce	1,08 m ² 24 kg 6 pce
Berechnungseinheit · Calculation unit	43,20 m ² 960 kg 40 box	43,20 m ² 960 kg 40 box	43,20 m ² 960 kg 40 box	43,20 m ² 960 kg 40 box
Preisgruppe · Price group	P (box)	P (box)	P (box)	P (box)
	m ²	m ²	m ²	m ²
	P87	P87	P87	P87
	30 x 60 cm	30 x 60 cm	30 x 60 cm	
Artikelnummer · Article number	2685	2526	2536	
Warengruppe · Product group	SB1M, SB6M, SB7M	SB1R, SB6R, SB7R	SB1V, SB6V, SB7V	
Werkmaße · Dimensions (mm)	SB9M	SB9R	SB9V	
Farbe · Colour	Grundfliese · Basic tile	Grundfliese · Basic tile	Grundfliese · Basic tile	
Oberfläche · Finish	297 x 597 x 10 mm	297 x 597 x 10 mm	297 x 597 x 10 mm	
Erzeugnisgruppe	-	-	-	
Material	matt Homogene Granitoptik reliefiert · matt Homogeneous granite look relief	matt Homogene Granitoptik reliefiert · matt Homogeneous granite look relief	matt Homogene Granitoptik reliefiert · matt Homogeneous granite look relief	
Maßeinheit · Unit of measure	VilbostonePlus	VilbostonePlus	VilbostonePlus	
Pro Paket · Per box	Feinsteinzeug	Feinsteinzeug	Feinsteinzeug	
Pro Palette · Per pallet	Porcelain stoneware	Porcelain stoneware	Porcelain stoneware	
Mindestabgabeneinheit · Min. sales unit	m ² 22,22 kg 5,56 pce	m ² 22,22 kg 5,56 pce	m ² 22,22 kg 5,56 pce	
Berechnungseinheit · Calculation unit	1,08 m ² 24 kg 6 pce	1,08 m ² 24 kg 6 pce	1,08 m ² 24 kg 6 pce	
Preisgruppe · Price group	43,20 m ² 960 kg 40 box	43,20 m ² 960 kg 40 box	43,20 m ² 960 kg 40 box	
	P (box)	P (box)	P (box)	
	m ²	m ²	m ²	
	P87	P87	P87	

Auftragsbezogene Fertigung, Mindestbestellmenge 100 m². Lieferzeit auf Anfrage.
Custom-made production. Minimum order quantity 100 m². Delivery time on request.

ABERDEEN Architektur Design (System) · Architecture Design (System)

Concept³



30 x 30 cm



Artikelnummer · Article number	2628
Warengruppe · Product group	SB10
Werksmaße · Dimensions (mm)	Grundfliese · Basic tile 297 x 297 x 10 mm
Farbe · Colour	pearl
Oberfläche · Finish	matt Homogene Granitoptik reliefiert · matt Homogeneous granite look relief VilbostonePlus
Erzeugnisgruppe	Feinsteinzeug
Material	Porcelain stoneware
Maßeinheit · Unit of measure	m ² 22 kg 11 pce
Pro Paket · Per box	1 m ² 22 kg 11 pce
Pro Palette · Per pallet	48 m ² 1056 kg 48 box
Mindestabgabereinheit · Min. sales unit	P (box)
Berechnungseinheit · Calculation unit	m ²
Preisgruppe · Price group	P105

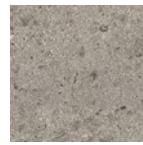

30 x 30 cm



Artikelnummer · Article number	2628
Warengruppe · Product group	SB70
Werksmaße · Dimensions (mm)	Grundfliese · Basic tile 297 x 297 x 10 mm
Farbe · Colour	tobacco
Oberfläche · Finish	matt Homogene Granitoptik reliefiert · matt Homogeneous granite look relief VilbostonePlus
Erzeugnisgruppe	Feinsteinzeug
Material	Porcelain stoneware
Maßeinheit · Unit of measure	m ² 22 kg 11 pce
Pro Paket · Per box	1 m ² 22 kg 11 pce
Pro Palette · Per pallet	48 m ² 1056 kg 48 box
Mindestabgabereinheit · Min. sales unit	P (box)
Berechnungseinheit · Calculation unit	m ²
Preisgruppe · Price group	P105

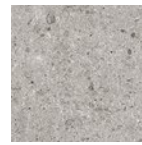

30 x 30 cm



Artikelnummer · Article number	2628
Warengruppe · Product group	SB60
Werksmaße · Dimensions (mm)	Grundfliese · Basic tile 297 x 297 x 10 mm
Farbe · Colour	opal grey
Oberfläche · Finish	matt Homogene Granitoptik reliefiert · matt Homogeneous granite look relief VilbostonePlus
Erzeugnisgruppe	Feinsteinzeug
Material	Porcelain stoneware
Maßeinheit · Unit of measure	m ² 22 kg 11 pce
Pro Paket · Per box	1 m ² 22 kg 11 pce
Pro Palette · Per pallet	48 m ² 1056 kg 48 box
Mindestabgabereinheit · Min. sales unit	P (box)
Berechnungseinheit · Calculation unit	m ²
Preisgruppe · Price group	P105

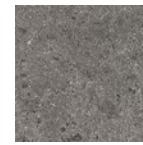

30 x 30 cm



Artikelnummer · Article number	2628
Warengruppe · Product group	SB90
Werksmaße · Dimensions (mm)	Grundfliese · Basic tile 297 x 297 x 10 mm
Farbe · Colour	slate grey
Oberfläche · Finish	matt Homogene Granitoptik reliefiert · matt Homogeneous granite look relief VilbostonePlus
Erzeugnisgruppe	Feinsteinzeug
Material	Porcelain stoneware
Maßeinheit · Unit of measure	m ² 22 kg 11 pce
Pro Paket · Per box	1 m ² 22 kg 11 pce
Pro Palette · Per pallet	48 m ² 1056 kg 48 box
Mindestabgabereinheit · Min. sales unit	P (box)
Berechnungseinheit · Calculation unit	m ²
Preisgruppe · Price group	P105

Auftragsbezogene Fertigung. Mindestbestellmenge 100 m². Lieferzeit auf Anfrage.
Custom-made production. Minimum order quantity 100 m². Delivery time on request.

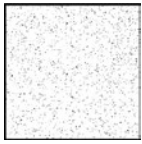

30 x 30 cm

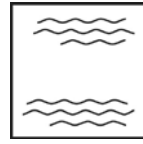

30 x 30 cm

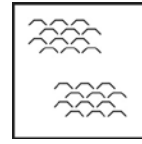

30 x 30 cm

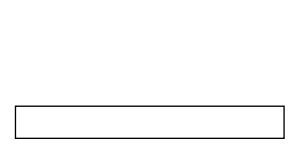

7,5 x 60 cm

Artikelnummer · Article number	2628
Warengruppe · Product group	SB1M, SB6M, SB7M
Werksmaße · Dimensions (mm)	SB9M
Farbe · Colour	-
Oberfläche · Finish	matt Homogene Granitoptik reliefiert · matt Homogeneous granite look relief VilbostonePlus
Erzeugnisgruppe	Feinsteinzeug
Material	Porcelain stoneware
Maßeinheit · Unit of measure	m ² 22 kg 11 pce
Pro Paket · Per box	1 m ² 22 kg 11 pce
Pro Palette · Per pallet	48 m ² 1056 kg 48 box
Mindestabgabereinheit · Min. sales unit	P (box)
Berechnungseinheit · Calculation unit	m ²
Preisgruppe · Price group	P105

Artikelnummer · Article number	2628
Warengruppe · Product group	SB1R, SB6R, SB7R
Werksmaße · Dimensions (mm)	SB9R
Farbe · Colour	-
Oberfläche · Finish	matt Homogene Granitoptik reliefiert · matt Homogeneous granite look relief VilbostonePlus
Erzeugnisgruppe	Feinsteinzeug
Material	Porcelain stoneware
Maßeinheit · Unit of measure	m ² 22 kg 11 pce
Pro Paket · Per box	1 m ² 22 kg 11 pce
Pro Palette · Per pallet	48 m ² 1056 kg 48 box
Mindestabgabereinheit · Min. sales unit	P (box)
Berechnungseinheit · Calculation unit	m ²
Preisgruppe · Price group	P105

Artikelnummer · Article number	2628
Warengruppe · Product group	SB1V, SB6V, SB7V
Werksmaße · Dimensions (mm)	SB9V
Farbe · Colour	-
Oberfläche · Finish	matt Homogene Granitoptik reliefiert · matt Homogeneous granite look relief VilbostonePlus
Erzeugnisgruppe	Feinsteinzeug
Material	Porcelain stoneware
Maßeinheit · Unit of measure	m ² 22 kg 11 pce
Pro Paket · Per box	1 m ² 22 kg 11 pce
Pro Palette · Per pallet	48 m ² 1056 kg 48 box
Mindestabgabereinheit · Min. sales unit	P (box)
Berechnungseinheit · Calculation unit	m ²
Preisgruppe · Price group	P105

Artikelnummer · Article number	2617
Warengruppe · Product group	SB10, SB60, SB70
Werksmaße · Dimensions (mm)	SB90
Farbe · Colour	-
Oberfläche · Finish	matt Homogene Granitoptik reliefiert · matt Homogeneous granite look relief VilbostonePlus
Erzeugnisgruppe	Feinsteinzeug
Material	Porcelain stoneware
Maßeinheit · Unit of measure	m ² 22,22 kg 22,22 pce
Pro Paket · Per box	0,90 m ² 20 kg 20 pce
Pro Palette · Per pallet	43,20 m ² 960 kg 48 box
Mindestabgabereinheit · Min. sales unit	P (box)
Berechnungseinheit · Calculation unit	m ²
Preisgruppe · Price group	P132

Auftragsbezogene Fertigung. Mindestbestellmenge 100 m². Lieferzeit auf Anfrage.
Custom-made production. Minimum order quantity 100 m². Delivery time on request.

ABERDEEN Architektur Design (System) · Architecture Design (System)

Concept³

2,5 x 15 cm □ 0,09 m ² 298 x 298 mm	2,5 x 15 cm □ 0,09 m ² 298 x 298 mm	2,5 x 15 cm □ 0,09 m ² 298 x 298 mm	2,5 x 15 cm □ 0,09 m ² 298 x 298 mm
2135 SB10	2135 SB70	2135 SB60	2135 SB90
Warengruppe · Product group Grundfliese · Basic tile	Warengruppe · Product group Grundfliese · Basic tile	Warengruppe · Product group Grundfliese · Basic tile	Warengruppe · Product group Grundfliese · Basic tile
Werksmaße · Dimensions (mm) 23 x 148 x 10 mm	Werksmaße · Dimensions (mm) 23 x 148 x 10 mm	Werksmaße · Dimensions (mm) 23 x 148 x 10 mm	Werksmaße · Dimensions (mm) 23 x 148 x 10 mm
Farbe · Colour pearl	Farbe · Colour tobacco	Farbe · Colour opal grey	Farbe · Colour slate grey
Oberfläche · Finish matt Homogene Granitoptik reliefiert · matt Homogeneous granite look relief VilbostonePlus	Oberfläche · Finish matt Homogene Granitoptik reliefiert · matt Homogeneous granite look relief VilbostonePlus	Oberfläche · Finish matt Homogene Granitoptik reliefiert · matt Homogeneous granite look relief VilbostonePlus	Oberfläche · Finish matt Homogene Granitoptik reliefiert · matt Homogeneous granite look relief VilbostonePlus
Erzeugnisgruppe Feinsteinzeug	Erzeugnisgruppe Feinsteinzeug	Erzeugnisgruppe Feinsteinzeug	Erzeugnisgruppe Feinsteinzeug
Material Porcelain stoneware	Material Porcelain stoneware	Material Porcelain stoneware	Material Porcelain stoneware
Maßeinheit · Unit of measure m ² 20,90 kg 11 pce	Maßeinheit · Unit of measure m ² 20,90 kg 11 pce	Maßeinheit · Unit of measure m ² 20,90 kg 11 pce	Maßeinheit · Unit of measure m ² 20,90 kg 11 pce
Pro Paket · Per box 1 m ² 20,90 kg 11 pce	Pro Paket · Per box 1 m ² 20,90 kg 11 pce	Pro Paket · Per box 1 m ² 20,90 kg 11 pce	Pro Paket · Per box 1 m ² 20,90 kg 11 pce
Pro Palette · Per pallet 36 m ² 752,40 kg 36 box	Pro Palette · Per pallet 36 m ² 752,40 kg 36 box	Pro Palette · Per pallet 36 m ² 752,40 kg 36 box	Pro Palette · Per pallet 36 m ² 752,40 kg 36 box
Mindestabgabereinheit · Min. sales unit P (box)	Mindestabgabereinheit · Min. sales unit P (box)	Mindestabgabereinheit · Min. sales unit P (box)	Mindestabgabereinheit · Min. sales unit P (box)
Berechnungseinheit · Calculation unit m ²	Berechnungseinheit · Calculation unit m ²	Berechnungseinheit · Calculation unit m ²	Berechnungseinheit · Calculation unit m ²
Preisgruppe · Price group P178	Preisgruppe · Price group P178	Preisgruppe · Price group P178	Preisgruppe · Price group P178
7,5 x 7,5 cm □ 0,09 m ² 297 x 297 mm	7,5 x 7,5 cm □ 0,09 m ² 297 x 297 mm	7,5 x 7,5 cm □ 0,09 m ² 297 x 297 mm	7,5 x 7,5 cm □ 0,09 m ² 297 x 297 mm
2013 SB10	2013 SB70	2013 SB60	2013 SB90
Warengruppe · Product group Grundfliese · Basic tile	Warengruppe · Product group Grundfliese · Basic tile	Warengruppe · Product group Grundfliese · Basic tile	Warengruppe · Product group Grundfliese · Basic tile
Werksmaße · Dimensions (mm) 72 x 72 x 10 mm	Werksmaße · Dimensions (mm) 72 x 72 x 10 mm	Werksmaße · Dimensions (mm) 72 x 72 x 10 mm	Werksmaße · Dimensions (mm) 72 x 72 x 10 mm
Farbe · Colour pearl	Farbe · Colour tobacco	Farbe · Colour opal grey	Farbe · Colour slate grey
Oberfläche · Finish matt Homogene Granitoptik reliefiert · matt Homogeneous granite look relief VilbostonePlus	Oberfläche · Finish matt Homogene Granitoptik reliefiert · matt Homogeneous granite look relief VilbostonePlus	Oberfläche · Finish matt Homogene Granitoptik reliefiert · matt Homogeneous granite look relief VilbostonePlus	Oberfläche · Finish matt Homogene Granitoptik reliefiert · matt Homogeneous granite look relief VilbostonePlus
Erzeugnisgruppe Feinsteinzeug	Erzeugnisgruppe Feinsteinzeug	Erzeugnisgruppe Feinsteinzeug	Erzeugnisgruppe Feinsteinzeug
Material Porcelain stoneware	Material Porcelain stoneware	Material Porcelain stoneware	Material Porcelain stoneware
Maßeinheit · Unit of measure m ² 21,45 kg 11 pce	Maßeinheit · Unit of measure m ² 21,45 kg 11 pce	Maßeinheit · Unit of measure m ² 21,45 kg 11 pce	Maßeinheit · Unit of measure m ² 21,45 kg 11 pce
Pro Paket · Per box 1 m ² 21,45 kg 11 pce	Pro Paket · Per box 1 m ² 21,45 kg 11 pce	Pro Paket · Per box 1 m ² 21,45 kg 11 pce	Pro Paket · Per box 1 m ² 21,45 kg 11 pce
Pro Palette · Per pallet 36 m ² 772,20 kg 36 box	Pro Palette · Per pallet 36 m ² 772,20 kg 36 box	Pro Palette · Per pallet 36 m ² 772,20 kg 36 box	Pro Palette · Per pallet 36 m ² 772,20 kg 36 box
Mindestabgabereinheit · Min. sales unit P (box)	Mindestabgabereinheit · Min. sales unit P (box)	Mindestabgabereinheit · Min. sales unit P (box)	Mindestabgabereinheit · Min. sales unit P (box)
Berechnungseinheit · Calculation unit m ²	Berechnungseinheit · Calculation unit m ²	Berechnungseinheit · Calculation unit m ²	Berechnungseinheit · Calculation unit m ²
Preisgruppe · Price group P169	Preisgruppe · Price group P169	Preisgruppe · Price group P169	Preisgruppe · Price group P169
10 x 30 cm			
2493 SB10, SB60, SB70 SB90			
Warengruppe · Product group Hohlkehlsockel · Cove base			
Werksmaße · Dimensions (mm) 107 x 297 x 9 mm			
Farbe · Colour -			
Oberfläche · Finish matt Homogene Granitoptik reliefiert · matt Homogeneous granite look relief VilbostonePlus			
Erzeugnisgruppe Feinsteinzeug			
Material Porcelain stoneware			
Maßeinheit · Unit of measure m 1,67 kg 3,33 pce			
Pro Paket · Per box 6,01 m 10 kg 20 pce			
Pro Palette · Per pallet 420,42 m 700 kg 70 box			
Mindestabgabereinheit · Min. sales unit E (pce)			
Berechnungseinheit · Calculation unit Stück · piece			
Preisgruppe · Price group E48			

CODE 2

Architektur Design (System) · Architecture Design (System)



60 x 120 cm
NEW 2023



60 x 120 cm
NEW 2023



60 x 120 cm
NEW 2023



20 x 120 cm
NEW 2023



Artikelnummer · Article number
Warengruppe · Product group
Werkgröße · Dimensions (mm)
Farbe · Colour
Oberfläche · Finish
Erzeugnisgruppe
Material
Maßeinheit · Unit of measure
Pro Paket · Per box
Pro Palette · Per pallet
Mindestabgabereinheit · Min. sales unit
Berechnungseinheit · Calculation unit
Preisgruppe · Price group

2730
SN70
Grundfliese · Basic tile
597 x 1197 x 10 mm
porfid
matt Steinstruktur · matt stone texture
VilbostonePlus
Feinsteinzeug
Porcelain stoneware
m ² 21,28 kg 1,39 pce
1,44 m ² 30,64 kg 2 pce
43,2 m ² 919,2 kg 30 box
P (box)
m ²
P110

2730
SN71
Grundfliese · Basic tile
597 x 1197 x 10 mm
ceppo light
matt Steinstruktur · matt stone texture
VilbostonePlus
Feinsteinzeug
Porcelain stoneware
m ² 21,28 kg 1,39 pce
1,44 m ² 30,64 kg 2 pce
43,2 m ² 919,2 kg 30 box
P (box)
m ²
P110

2730
SN72
Grundfliese · Basic tile
597 x 1197 x 10 mm
ceppo dark
matt Steinstruktur · matt stone texture
VilbostonePlus
Feinsteinzeug
Porcelain stoneware
m ² 21,28 kg 1,39 pce
1,44 m ² 30,64 kg 2 pce
43,2 m ² 919,2 kg 30 box
P (box)
m ²
P110

2795
SN80
Grundfliese · Basic tile
197 x 1197 x 10 mm
natural
matt Holzoptik · matt wood look
VilbostonePlus
Feinsteinzeug
Porcelain stoneware
m ² 21,46 kg 4,17 pce
0,96 m ² 20,60 kg 4 pce
46,08 m ² 988,80 kg 48 box
P (box)
m ²
P109



60 x 120 cm
NEW 2023



60 x 120 cm
NEW 2023



60 x 120 cm
NEW 2023



20 x 120 cm
NEW 2023



Artikelnummer · Article number
Warengruppe · Product group
Werkgröße · Dimensions (mm)
Farbe · Colour
Oberfläche · Finish
Erzeugnisgruppe
Material
Maßeinheit · Unit of measure
Pro Paket · Per box
Pro Palette · Per pallet
Mindestabgabereinheit · Min. sales unit
Berechnungseinheit · Calculation unit
Preisgruppe · Price group

2730
SN60
Grundfliese · Basic tile
597 x 1197 x 10 mm
stone
matt Steinstruktur · matt stone texture
VilbostonePlus
Feinsteinzeug
Porcelain stoneware
m ² 21,28 kg 1,39 pce
1,44 m ² 30,64 kg 2 pce
43,2 m ² 919,2 kg 30 box
P (box)
m ²
P110

2730
SN61
Grundfliese · Basic tile
597 x 1197 x 10 mm
rock light
matt Steinstruktur · matt stone texture
VilbostonePlus
Feinsteinzeug
Porcelain stoneware
m ² 21,28 kg 1,39 pce
1,44 m ² 30,64 kg 2 pce
43,2 m ² 919,2 kg 30 box
P (box)
m ²
P110

2730
SN62
Grundfliese · Basic tile
597 x 1197 x 10 mm
rock dark
matt Steinstruktur · matt stone texture
VilbostonePlus
Feinsteinzeug
Porcelain stoneware
m ² 21,28 kg 1,39 pce
1,44 m ² 30,64 kg 2 pce
43,2 m ² 919,2 kg 30 box
P (box)
m ²
P110

2795
SN20
Grundfliese · Basic tile
197 x 1197 x 10 mm
honey
matt Holzoptik · matt wood look
VilbostonePlus
Feinsteinzeug
Porcelain stoneware
m ² 21,46 kg 4,17 pce
0,96 m ² 20,60 kg 4 pce
46,08 m ² 988,80 kg 48 box
P (box)
m ²
P109

CODE 2

Architektur Design (System) · Architecture Design (System)

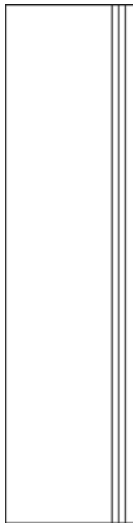

30 x 120 cm
NEW 2023



80 x 80 cm
NEW 2023



Artikelnummer · Article number	2732	2810
Warengruppe · Product group	SN60, SN61, SN62 SN70, SN71, SN72	SN70
Werksmaße · Dimensions (mm)	Treppenauftritt · Stair tread 297 x 1197 x 10 mm	Grundfliese · Basic tile 797 x 797 x 9 mm
Farbe · Colour	-	porfid
Oberfläche · Finish	matt Steinstruktur · matt stone texture	matt Steinstruktur · matt stone texture
Erzeugnisgruppe	Feinsteinzeug	Feinsteinzeug
Material	Porcelain stoneware	Porcelain stoneware
Maßeinheit · Unit of measure	m 5,89 kg 0,83 pce	m ² 19,06 kg 1,56 pce
Pro Paket · Per box	2,41 m 14,20 kg 2 pce	1,28 m ² 24,40 kg 2 pce
Pro Palette · Per pallet	106,02 m 624,80 kg 44 box	51,20 m ² 976 kg 40 box
Mindestabgabereinheit · Min. sales unit	E (pce)	P (box)
Berechnungseinheit · Calculation unit	Stück · piece	m ²
Preisgruppe · Price group	E118	P110

Auftragsbezogene Fertigung der Treppen in der zu bestellten Grundfliese passenden Nuance.
Lieferzeit auf Anfrage.
Steps made to order in the nuance that matches the basic tile ordered. Delivery time on request.



80 x 80 cm
NEW 2023



80 x 80 cm
NEW 2023



Artikelnummer · Article number	2810	2810
Warengruppe · Product group	SN71	SN72
Werksmaße · Dimensions (mm)	Grundfliese · Basic tile 797 x 797 x 9 mm	Grundfliese · Basic tile 797 x 797 x 9 mm
Farbe · Colour	ceppo light	ceppo dark
Oberfläche · Finish	matt Steinstruktur · matt stone texture	matt Steinstruktur · matt stone texture
Erzeugnisgruppe	Feinsteinzeug	Feinsteinzeug
Material	Porcelain stoneware	Porcelain stoneware
Maßeinheit · Unit of measure	m ² 19,06 kg 1,56 pce	m ² 19,06 kg 1,56 pce
Pro Paket · Per box	1,28 m ² 24,40 kg 2 pce	1,28 m ² 24,40 kg 2 pce
Pro Palette · Per pallet	51,20 m ² 976 kg 40 box	51,20 m ² 976 kg 40 box
Mindestabgabereinheit · Min. sales unit	P (box)	P (box)
Berechnungseinheit · Calculation unit	m ²	m ²
Preisgruppe · Price group	P110	P110

CODE 2

Architektur Design (System) · Architecture Design (System)









80 x 80 cm
NEW 2023



80 x 80 cm
NEW 2023

Artikelnummer · Article number
Warengruppe · Product group
Werkmaße · Dimensions (mm)
Farbe · Colour
Oberfläche · Finish
Erzeugnisgruppe
Material
Maßeinheit · Unit of measure
Pro Paket · Per box
Pro Palette · Per pallet
Mindestabgabereinheit · Min. sales unit
Berechnungseinheit · Calculation unit
Preisgruppe · Price group



2810
SN60   
Grundfliese · Basic tile
797 x 797 x 9 mm
stone
matt Steinstruktur · matt stone texture VilbostonePlus
Feinsteinzeug
Porcelain stoneware
m ² 19,06 kg 1,56 pce
1,28 m ² 24,40 kg 2 pce
51,20 m ² 976 kg 40 box
P (box)
m ²
P110

2810
SN61   
Grundfliese · Basic tile
797 x 797 x 9 mm
rock light
matt Steinstruktur · matt stone texture VilbostonePlus
Feinsteinzeug
Porcelain stoneware
m ² 19,06 kg 1,56 pce
1,28 m ² 24,40 kg 2 pce
51,20 m ² 976 kg 40 box
P (box)
m ²
P110



80 x 80 cm
NEW 2023

Artikelnummer · Article number
Warengruppe · Product group
Werkmaße · Dimensions (mm)
Farbe · Colour
Oberfläche · Finish
Erzeugnisgruppe
Material
Maßeinheit · Unit of measure
Pro Paket · Per box
Pro Palette · Per pallet
Mindestabgabereinheit · Min. sales unit
Berechnungseinheit · Calculation unit
Preisgruppe · Price group

2810
SN62   
Grundfliese · Basic tile
797 x 797 x 9 mm
rock dark
matt Steinstruktur · matt stone texture VilbostonePlus
Feinsteinzeug
Porcelain stoneware
m ² 19,06 kg 1,56 pce
1,28 m ² 24,40 kg 2 pce
51,20 m ² 976 kg 40 box
P (box)
m ²
P110

CODE 2

Architektur Design (System) · Architecture Design (System)



60 x 60 cm
NEW 2023



60 x 60 cm
NEW 2023



60 x 60 cm
NEW 2023

Artikelnummer · Article number
Warengruppe · Product group
Werkmaße · Dimensions (mm)
Farbe · Colour
Oberfläche · Finish
Erzeugnisgruppe
Material
Maßeinheit · Unit of measure
Pro Paket · Per box
Pro Palette · Per pallet
Mindestabgabereinheit · Min. sales unit
Berechnungseinheit · Calculation unit
Preisgruppe · Price group

2660
SN70
Grundfliese · Basic tile
597 x 597 x 9 mm
porfid
matt Steinstruktur · matt stone texture
VilbostonePlus
Feinsteinzeug
Porcelain stoneware
m ² 19,72 kg 2,78 pce
1,44 m ² 28,40 kg 4 pce
43,20 m ² 852 kg 30 box
P (box)
m ²
P93

2660
SN71
Grundfliese · Basic tile
597 x 597 x 9 mm
ceppo light
matt Steinstruktur · matt stone texture
VilbostonePlus
Feinsteinzeug
Porcelain stoneware
m ² 19,72 kg 2,78 pce
1,44 m ² 28,40 kg 4 pce
43,20 m ² 852 kg 30 box
P (box)
m ²
P93

2660
SN72
Grundfliese · Basic tile
597 x 597 x 9 mm
ceppo dark
matt Steinstruktur · matt stone texture
VilbostonePlus
Feinsteinzeug
Porcelain stoneware
m ² 19,72 kg 2,78 pce
1,44 m ² 28,40 kg 4 pce
43,20 m ² 852 kg 30 box
P (box)
m ²
P93



60 x 60 cm
NEW 2023

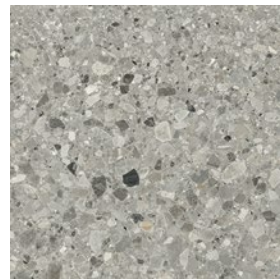

60 x 60 cm
NEW 2023

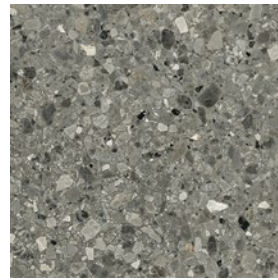

60 x 60 cm
NEW 2023

Artikelnummer · Article number
Warengruppe · Product group
Werkmaße · Dimensions (mm)
Farbe · Colour
Oberfläche · Finish
Erzeugnisgruppe
Material
Maßeinheit · Unit of measure
Pro Paket · Per box
Pro Palette · Per pallet
Mindestabgabereinheit · Min. sales unit
Berechnungseinheit · Calculation unit
Preisgruppe · Price group

2660
SN60
Grundfliese · Basic tile
597 x 597 x 9 mm
stone
matt Steinstruktur · matt stone texture
VilbostonePlus
Feinsteinzeug
Porcelain stoneware
m ² 19,72 kg 2,78 pce
1,44 m ² 28,40 kg 4 pce
43,20 m ² 852 kg 30 box
P (box)
m ²
P93

2660
SN61
Grundfliese · Basic tile
597 x 597 x 9 mm
rock light
matt Steinstruktur · matt stone texture
VilbostonePlus
Feinsteinzeug
Porcelain stoneware
m ² 19,72 kg 2,78 pce
1,44 m ² 28,40 kg 4 pce
43,20 m ² 852 kg 30 box
P (box)
m ²
P93

2660
SN62
Grundfliese · Basic tile
597 x 597 x 9 mm
rock dark
matt Steinstruktur · matt stone texture
VilbostonePlus
Feinsteinzeug
Porcelain stoneware
m ² 19,72 kg 2,78 pce
1,44 m ² 28,40 kg 4 pce
43,20 m ² 852 kg 30 box
P (box)
m ²
P93

CODE 2

Architektur Design (System) · Architecture Design (System)

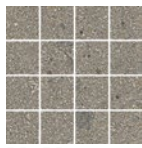

7,5 x 7,5 cm
NEW 2023
0,09 m² | 297 x 297 mm

Artikelnummer · Article number	2013
Warengruppe · Product group	SN70
Werkgröße · Dimensions (mm)	Grundfliese · Basic tile
Farbe · Colour	72 x 72 x 9 mm
Oberfläche · Finish	porfid
Erzeugnisgruppe	matt Steinstruktur · matt stone texture VilbostonePlus
Material	Feinsteinzeug
Maßeinheit · Unit of measure	Porcelain stoneware
Pro Paket · Per box	m ² 20,90 kg 11 pce
Pro Palette · Per pallet	1 m ² 20,90 kg 11 pce
Mindestabgabereinheit · Min. sales unit	36 m ² 752,40 kg 36 box
Berechnungseinheit · Calculation unit	P (box)
Preisgruppe · Price group	m ² P167

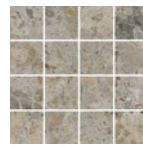

7,5 x 7,5 cm
NEW 2023
0,09 m² | 297 x 297 mm

Artikelnummer · Article number	2013
Warengruppe · Product group	SN71
Werkgröße · Dimensions (mm)	Grundfliese · Basic tile
Farbe · Colour	72 x 72 x 9 mm
Oberfläche · Finish	ceppo light
Erzeugnisgruppe	matt Steinstruktur · matt stone texture VilbostonePlus
Material	Feinsteinzeug
Maßeinheit · Unit of measure	Porcelain stoneware
Pro Paket · Per box	m ² 20,90 kg 11 pce
Pro Palette · Per pallet	1 m ² 20,90 kg 11 pce
Mindestabgabereinheit · Min. sales unit	36 m ² 752,40 kg 36 box
Berechnungseinheit · Calculation unit	P (box)
Preisgruppe · Price group	m ² P167

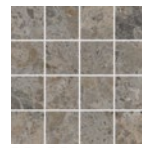

7,5 x 7,5 cm
NEW 2023
0,09 m² | 297 x 297 mm

Artikelnummer · Article number	2013
Warengruppe · Product group	SN72
Werkgröße · Dimensions (mm)	Grundfliese · Basic tile
Farbe · Colour	72 x 72 x 9 mm
Oberfläche · Finish	ceppo dark
Erzeugnisgruppe	matt Steinstruktur · matt stone texture VilbostonePlus
Material	Feinsteinzeug
Maßeinheit · Unit of measure	Porcelain stoneware
Pro Paket · Per box	m ² 20,90 kg 11 pce
Pro Palette · Per pallet	1 m ² 20,90 kg 11 pce
Mindestabgabereinheit · Min. sales unit	36 m ² 752,40 kg 36 box
Berechnungseinheit · Calculation unit	P (box)
Preisgruppe · Price group	m ² P167

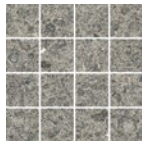

7,5 x 7,5 cm
NEW 2023
0,09 m² | 297 x 297 mm

Artikelnummer · Article number	2013
Warengruppe · Product group	SN60
Werkgröße · Dimensions (mm)	Grundfliese · Basic tile
Farbe · Colour	72 x 72 x 9 mm
Oberfläche · Finish	stone
Erzeugnisgruppe	matt Steinstruktur · matt stone texture VilbostonePlus
Material	Feinsteinzeug
Maßeinheit · Unit of measure	Porcelain stoneware
Pro Paket · Per box	m ² 20,90 kg 11 pce
Pro Palette · Per pallet	1 m ² 20,90 kg 11 pce
Mindestabgabereinheit · Min. sales unit	36 m ² 752,40 kg 36 box
Berechnungseinheit · Calculation unit	P (box)
Preisgruppe · Price group	m ² P167

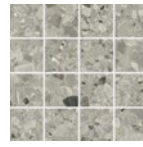

7,5 x 7,5 cm
NEW 2023
0,09 m² | 297 x 297 mm

Artikelnummer · Article number	2013
Warengruppe · Product group	SN61
Werkgröße · Dimensions (mm)	Grundfliese · Basic tile
Farbe · Colour	72 x 72 x 9 mm
Oberfläche · Finish	rock light
Erzeugnisgruppe	matt Steinstruktur · matt stone texture VilbostonePlus
Material	Feinsteinzeug
Maßeinheit · Unit of measure	Porcelain stoneware
Pro Paket · Per box	m ² 20,90 kg 11 pce
Pro Palette · Per pallet	1 m ² 20,90 kg 11 pce
Mindestabgabereinheit · Min. sales unit	36 m ² 752,40 kg 36 box
Berechnungseinheit · Calculation unit	P (box)
Preisgruppe · Price group	m ² P167

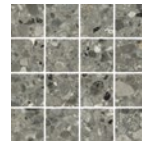

7,5 x 7,5 cm
NEW 2023
0,09 m² | 297 x 297 mm

Artikelnummer · Article number	2013
Warengruppe · Product group	SN62
Werkgröße · Dimensions (mm)	Grundfliese · Basic tile
Farbe · Colour	72 x 72 x 9 mm
Oberfläche · Finish	rock dark
Erzeugnisgruppe	matt Steinstruktur · matt stone texture VilbostonePlus
Material	Feinsteinzeug
Maßeinheit · Unit of measure	Porcelain stoneware
Pro Paket · Per box	m ² 20,90 kg 11 pce
Pro Palette · Per pallet	1 m ² 20,90 kg 11 pce
Mindestabgabereinheit · Min. sales unit	36 m ² 752,40 kg 36 box
Berechnungseinheit · Calculation unit	P (box)
Preisgruppe · Price group	m ² P167

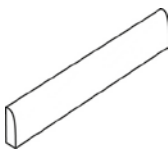

5 x 60 cm
NEW 2023

Artikelnummer · Article number	2875
Warengruppe · Product group	SN60, SN61, SN62
Werkgröße · Dimensions (mm)	SN70, SN71, SN72
Farbe · Colour	Sockel · Skirting
Oberfläche · Finish	48 x 597 x 9 mm
Erzeugnisgruppe	-
Material	matt Steinstruktur · matt stone texture VilbostonePlus
Maßeinheit · Unit of measure	Feinsteinzeug
Pro Paket · Per box	Porcelain stoneware
Pro Palette · Per pallet	m 1,05 kg 1,66 pce
Mindestabgabereinheit · Min. sales unit	9,04 m 9,45 kg 15 pce
Berechnungseinheit · Calculation unit	433,74 m 453,60 kg 48 box
Preisgruppe · Price group	E (pce) Stück · piece E55











DAYTONA Architektur Design (Basis) - Architecture Design (Basis)

30 x 60 cm	30 x 60 cm	30 x 60 cm	30 x 60 cm
2341	2341	2341	2341
BP20	BP70	BP60	BP90
Grundfliese - Basic tile	Grundfliese - Basic tile	Grundfliese - Basic tile	Grundfliese - Basic tile
Werkmaße - Dimensions (mm) 297 x 597 x 9 mm	Werkmaße - Dimensions (mm) 297 x 597 x 9 mm	Werkmaße - Dimensions (mm) 297 x 597 x 9 mm	Werkmaße - Dimensions (mm) 297 x 597 x 9 mm
Farbe - Colour beige	Farbe - Colour greige	Farbe - Colour grey	Farbe - Colour dark grey
Oberfläche - Finish matt Keramikstruktur · matt ceramic texture VilbostonePlus	Oberfläche - Finish matt Keramikstruktur · matt ceramic texture VilbostonePlus	Oberfläche - Finish matt Keramikstruktur · matt ceramic texture VilbostonePlus	Oberfläche - Finish matt Keramikstruktur · matt ceramic texture VilbostonePlus
Erzeugnisgruppe Feinsteinzeug	Erzeugnisgruppe Feinsteinzeug	Erzeugnisgruppe Feinsteinzeug	Erzeugnisgruppe Feinsteinzeug
Material Porcelain stoneware	Material Porcelain stoneware	Material Porcelain stoneware	Material Porcelain stoneware
Maßeinheit - Unit of measure m ² 19,22 kg 5,56 pce	Maßeinheit - Unit of measure m ² 19,22 kg 5,56 pce	Maßeinheit - Unit of measure m ² 19,22 kg 5,56 pce	Maßeinheit - Unit of measure m ² 19,22 kg 5,56 pce
Pro Paket - Per box 1,08 m ² 20,76 kg 6 pce	Pro Paket - Per box 1,08 m ² 20,76 kg 6 pce	Pro Paket - Per box 1,08 m ² 20,76 kg 6 pce	Pro Paket - Per box 1,08 m ² 20,76 kg 6 pce
Pro Palette - Per pallet 43,20 m ² 830,40 kg 40 box	Pro Palette - Per pallet 43,20 m ² 830,40 kg 40 box	Pro Palette - Per pallet 43,20 m ² 830,40 kg 40 box	Pro Palette - Per pallet 43,20 m ² 830,40 kg 40 box
Mindestabgabereinheit - Min. sales unit P (box)	Mindestabgabereinheit - Min. sales unit P (box)	Mindestabgabereinheit - Min. sales unit P (box)	Mindestabgabereinheit - Min. sales unit P (box)
Berechnungseinheit - Calculation unit m ²	Berechnungseinheit - Calculation unit m ²	Berechnungseinheit - Calculation unit m ²	Berechnungseinheit - Calculation unit m ²
Preisgruppe - Price group P84	Preisgruppe - Price group P84	Preisgruppe - Price group P84	Preisgruppe - Price group P84
5 x 5 cm	5 x 5 cm	5 x 5 cm	5 x 5 cm
<input type="checkbox"/> 0,09 m ² 298 x 298 mm	<input type="checkbox"/> 0,09 m ² 298 x 298 mm	<input type="checkbox"/> 0,09 m ² 298 x 298 mm	<input type="checkbox"/> 0,09 m ² 298 x 298 mm
2706	2706	2706	2706
BP20	BP70	BP60	BP90
Grundfliese - Basic tile	Grundfliese - Basic tile	Grundfliese - Basic tile	Grundfliese - Basic tile
Werkmaße - Dimensions (mm) 48 x 48 x 6 mm	Werkmaße - Dimensions (mm) 48 x 48 x 6 mm	Werkmaße - Dimensions (mm) 48 x 48 x 6 mm	Werkmaße - Dimensions (mm) 48 x 48 x 6 mm
Farbe - Colour beige	Farbe - Colour greige	Farbe - Colour grey	Farbe - Colour dark grey
Oberfläche - Finish matt Keramikstruktur · matt ceramic texture	Oberfläche - Finish matt Keramikstruktur · matt ceramic texture	Oberfläche - Finish matt Keramikstruktur · matt ceramic texture	Oberfläche - Finish matt Keramikstruktur · matt ceramic texture
Erzeugnisgruppe Feinsteinzeug glasiert	Erzeugnisgruppe Feinsteinzeug glasiert	Erzeugnisgruppe Feinsteinzeug glasiert	Erzeugnisgruppe Feinsteinzeug glasiert
Material Glazed porcelain stoneware	Material Glazed porcelain stoneware	Material Glazed porcelain stoneware	Material Glazed porcelain stoneware
Maßeinheit - Unit of measure m ² 11,77 kg 11 pce	Maßeinheit - Unit of measure m ² 11,77 kg 11 pce	Maßeinheit - Unit of measure m ² 11,77 kg 11 pce	Maßeinheit - Unit of measure m ² 11,77 kg 11 pce
Pro Paket - Per box 1 m ² 11,77 kg 11 pce	Pro Paket - Per box 1 m ² 11,77 kg 11 pce	Pro Paket - Per box 1 m ² 11,77 kg 11 pce	Pro Paket - Per box 1 m ² 11,77 kg 11 pce
Pro Palette - Per pallet 78 m ² 918,06 kg 78 box	Pro Palette - Per pallet 78 m ² 918,06 kg 78 box	Pro Palette - Per pallet 78 m ² 918,06 kg 78 box	Pro Palette - Per pallet 78 m ² 918,06 kg 78 box
Mindestabgabereinheit - Min. sales unit P (box)	Mindestabgabereinheit - Min. sales unit P (box)	Mindestabgabereinheit - Min. sales unit P (box)	Mindestabgabereinheit - Min. sales unit P (box)
Berechnungseinheit - Calculation unit m ²	Berechnungseinheit - Calculation unit m ²	Berechnungseinheit - Calculation unit m ²	Berechnungseinheit - Calculation unit m ²
Preisgruppe - Price group P116	Preisgruppe - Price group P116	Preisgruppe - Price group P116	Preisgruppe - Price group P116





ÉDITION C Architektur Design (Basis) - Architecture Design (Basis)

20 x 40 cm	20 x 40 cm	20 x 40 cm	20 x 40 cm
1240	1240	1240	1240
EF00	EF01	EF62	EF63
Grundfliese - Basic tile	Grundfliese - Basic tile	Grundfliese - Basic tile	Grundfliese - Basic tile
Werkmaße - Dimensions (mm) 197 x 397 x 7 mm	Werkmaße - Dimensions (mm) 197 x 397 x 7 mm	Werkmaße - Dimensions (mm) 197 x 397 x 7 mm	Werkmaße - Dimensions (mm) 197 x 397 x 7 mm
Farbe - Colour white	Farbe - Colour white	Farbe - Colour medium grey	Farbe - Colour medium grey
Oberfläche - Finish matt	Oberfläche - Finish glänzend · glossy	Oberfläche - Finish matt	Oberfläche - Finish glänzend · glossy
Erzeugnisgruppe Steingut	Erzeugnisgruppe Steingut	Erzeugnisgruppe Steingut	Erzeugnisgruppe Steingut
Material Nonvitreous	Material Nonvitreous	Material Nonvitreous	Material Nonvitreous
Maßeinheit - Unit of measure m ² 13 kg 12,50 pce	Maßeinheit - Unit of measure m ² 13 kg 12,50 pce	Maßeinheit - Unit of measure m ² 13 kg 12,50 pce	Maßeinheit - Unit of measure m ² 13 kg 12,50 pce
Pro Paket - Per box 0,96 m ² 12,48 kg 12 pce	Pro Paket - Per box 0,96 m ² 12,48 kg 12 pce	Pro Paket - Per box 0,96 m ² 12,48 kg 12 pce	Pro Paket - Per box 0,96 m ² 12,48 kg 12 pce
Pro Palette - Per pallet 69,12 m ² 898,56 kg 72 box	Pro Palette - Per pallet 69,12 m ² 898,56 kg 72 box	Pro Palette - Per pallet 69,12 m ² 898,56 kg 72 box	Pro Palette - Per pallet 69,12 m ² 898,56 kg 72 box
Mindestabgabereinheit - Min. sales unit P (box)	Mindestabgabereinheit - Min. sales unit P (box)	Mindestabgabereinheit - Min. sales unit P (box)	Mindestabgabereinheit - Min. sales unit P (box)
Berechnungseinheit - Calculation unit m ²	Berechnungseinheit - Calculation unit m ²	Berechnungseinheit - Calculation unit m ²	Berechnungseinheit - Calculation unit m ²
Preisgruppe - Price group P71	Preisgruppe - Price group P71	Preisgruppe - Price group P71	Preisgruppe - Price group P71

ÉDITION C Architektur Design (Basis) - Architecture Design (Basis)

				
	20 x 40 cm	20 x 40 cm	20 x 40 cm	20 x 40 cm
Artikelnummer · Article number	1240	1240	1240	1240
	EF64	EF65	EF90	EF91
Warengruppe · Product group	Grundfliese · Basic tile	Grundfliese · Basic tile	Grundfliese · Basic tile	Grundfliese · Basic tile
Werksmaße · Dimensions (mm)	197 x 397 x 7 mm	197 x 397 x 7 mm	197 x 397 x 7 mm	197 x 397 x 7 mm
Farbe · Colour	dark grey	dark grey	black	black
Oberfläche · Finish	matt	glänzend · glossy	matt	glänzend · glossy
Erzeugnisgruppe	Steingut	Steingut	Steingut	Steingut
Material	Nonvitreous	Nonvitreous	Nonvitreous	Nonvitreous
Maßeinheit · Unit of measure	m ² 13 kg 12,50 pce	m ² 13 kg 12,50 pce	m ² 13 kg 12,50 pce	m ² 13 kg 12,50 pce
Pro Paket · Per box	0,96 m ² 12,48 kg 12 pce	0,96 m ² 12,48 kg 12 pce	0,96 m ² 12,48 kg 12 pce	0,96 m ² 12,48 kg 12 pce
Pro Palette · Per pallet	69,12 m ² 898,56 kg 72 box	69,12 m ² 898,56 kg 72 box	69,12 m ² 898,56 kg 72 box	69,12 m ² 898,56 kg 72 box
Mindestabgabereinheit · Min. sales unit	P (box)	P (box)	P (box)	P (box)
Berechnungseinheit · Calculation unit	m ²	m ²	m ²	m ²
Preisgruppe · Price group	P71	P71	P71	P71
				
	20 x 40 cm	20 x 40 cm	20 x 40 cm	20 x 40 cm
Artikelnummer · Article number	1240	1240	1240	1240
	EF10	EF11	EF20	EF21
Warengruppe · Product group	Grundfliese · Basic tile	Grundfliese · Basic tile	Grundfliese · Basic tile	Grundfliese · Basic tile
Werksmaße · Dimensions (mm)	197 x 397 x 7 mm	197 x 397 x 7 mm	197 x 397 x 7 mm	197 x 397 x 7 mm
Farbe · Colour	creme	creme	beige	beige
Oberfläche · Finish	matt	glänzend · glossy	matt	glänzend · glossy
Erzeugnisgruppe	Steingut	Steingut	Steingut	Steingut
Material	Nonvitreous	Nonvitreous	Nonvitreous	Nonvitreous
Maßeinheit · Unit of measure	m ² 13 kg 12,50 pce	m ² 13 kg 12,50 pce	m ² 13 kg 12,50 pce	m ² 13 kg 12,50 pce
Pro Paket · Per box	0,96 m ² 12,48 kg 12 pce	0,96 m ² 12,48 kg 12 pce	0,96 m ² 12,48 kg 12 pce	0,96 m ² 12,48 kg 12 pce
Pro Palette · Per pallet	69,12 m ² 898,56 kg 72 box	69,12 m ² 898,56 kg 72 box	69,12 m ² 898,56 kg 72 box	69,12 m ² 898,56 kg 72 box
Mindestabgabereinheit · Min. sales unit	P (box)	P (box)	P (box)	P (box)
Berechnungseinheit · Calculation unit	m ²	m ²	m ²	m ²
Preisgruppe · Price group	P71	P71	P77	P77
				
	20 x 40 cm	20 x 40 cm	20 x 40 cm	20 x 40 cm
Artikelnummer · Article number	1240	1240	1240	1240
	EF70	EF71	EF50	EF51
Warengruppe · Product group	Grundfliese · Basic tile	Grundfliese · Basic tile	Grundfliese · Basic tile	Grundfliese · Basic tile
Werksmaße · Dimensions (mm)	197 x 397 x 7 mm	197 x 397 x 7 mm	197 x 397 x 7 mm	197 x 397 x 7 mm
Farbe · Colour	taupe	taupe	green	green
Oberfläche · Finish	matt	glänzend · glossy	matt	glänzend · glossy
Erzeugnisgruppe	Steingut	Steingut	Steingut	Steingut
Material	Nonvitreous	Nonvitreous	Nonvitreous	Nonvitreous
Maßeinheit · Unit of measure	m ² 13 kg 12,50 pce	m ² 13 kg 12,50 pce	m ² 13 kg 12,50 pce	m ² 13 kg 12,50 pce
Pro Paket · Per box	0,96 m ² 12,48 kg 12 pce	0,96 m ² 12,48 kg 12 pce	0,96 m ² 12,48 kg 12 pce	0,96 m ² 12,48 kg 12 pce
Pro Palette · Per pallet	69,12 m ² 898,56 kg 72 box	69,12 m ² 898,56 kg 72 box	69,12 m ² 898,56 kg 72 box	69,12 m ² 898,56 kg 72 box
Mindestabgabereinheit · Min. sales unit	P (box)	P (box)	P (box)	P (box)
Berechnungseinheit · Calculation unit	m ²	m ²	m ²	m ²
Preisgruppe · Price group	P77	P77	P77	P77

ÉDITION C Architektur Design (Basis) - Architecture Design (Basis)







				
	20 x 40 cm	20 x 40 cm	20 x 40 cm	20 x 40 cm
Artikelnummer · Article number	1240	1240	1240	1240
	EF30	EF31	EF40	EF41
Warengruppe · Product group	Grundfliese · Basic tile	Grundfliese · Basic tile	Grundfliese · Basic tile	Grundfliese · Basic tile
Werkmaße · Dimensions (mm)	197 x 397 x 7 mm	197 x 397 x 7 mm	197 x 397 x 7 mm	197 x 397 x 7 mm
Farbe · Colour	red	red	blue	blue
Oberfläche · Finish	matt	glänzend · glossy	matt	glänzend · glossy
Erzeugnisgruppe	Steingut	Steingut	Steingut	Steingut
Material	Nonvitreous	Nonvitreous	Nonvitreous	Nonvitreous
Maßeinheit · Unit of measure	m ² 13 kg 12,50 pce	m ² 13 kg 12,50 pce	m ² 13 kg 12,50 pce	m ² 13 kg 12,50 pce
Pro Paket · Per box	0,96 m ² 12,48 kg 12 pce	0,96 m ² 12,48 kg 12 pce	0,96 m ² 12,48 kg 12 pce	0,96 m ² 12,48 kg 12 pce
Pro Palette · Per pallet	69,12 m ² 898,56 kg 72 box	69,12 m ² 898,56 kg 72 box	69,12 m ² 898,56 kg 72 box	69,12 m ² 898,56 kg 72 box
Mindestabgabereinheit · Min. sales unit	P (box)	P (box)	P (box)	P (box)
Berechnungseinheit · Calculation unit	m ²	m ²	m ²	m ²
Preisgruppe · Price group	P77	P77	P77	P77

HUDSON Architektur Design (System) · Architecture Design (System)



120 x 260 cm 

120 x 260 cm 

Artikelnummer · Article number	2962	OPTIMA 6 mm	2962	OPTIMA 6 mm
	SD1B	  R9 	SD2B	  R9 
Warengruppe · Product group	Grundfliese · Basic tile		Grundfliese · Basic tile	
Werksmaße · Dimensions (mm)	1197 x 2600 x 6 mm		1197 x 2600 x 6 mm	
Farbe · Colour	white sand		sand	
Oberfläche · Finish	matt Sandstruktur · matt sand structure		matt Sandstruktur · matt sand structure	
Erzeugnisgruppe	Feinsteinzeug		Feinsteinzeug	
Material	Porcelain stoneware		Porcelain stoneware	
Maßeinheit · Unit of measure	m ² 13,96 kg 0,32 pce		m ² 13,96 kg 0,32 pce	
Pro Paket · Per box	3,12 m ² 43,57 kg 1 pce		3,12 m ² 43,57 kg 1 pce	
Pro Palette · Per pallet	68,64 m ² 958,54 kg 22 box		68,64 m ² 958,54 kg 22 box	
Mindestabgabereinheit · Min. sales unit	Stück · piece		Stück · piece	
Berechnungseinheit · Calculation unit	m ²		m ²	
Preisgruppe · Price group	P156		P156	







Für Wändenwendungen empfohlen.
 * Nur Längskante rektifiziert.
 Recommended for wall coverings.
 *only the long side of the tiles is rectified.

HUDSON Architektur Design (System) · Architecture Design (System)



120 x 260 cm 

120 x 260 cm 

Artikelnummer · Article number	2962	OPTIMA 6 mm	2962	OPTIMA 6 mm
Warengruppe · Product group	SD7B	  R9 	SD9B	  R9 
Werksmaße · Dimensions (mm)	Grundfliese · Basic tile		Grundfliese · Basic tile	
Farbe · Colour	1197 x 2600 x 6 mm		1197 x 2600 x 6 mm	
Oberfläche · Finish	clay		volcano	
Erzeugnisgruppe	matt Sandstruktur · matt sand structure	VilbostonePlus	matt Sandstruktur · matt sand structure	VilbostonePlus
Material	Feinsteinzeug		Feinsteinzeug	
Maßeinheit · Unit of measure	Porcelain stoneware		Porcelain stoneware	
Pro Paket · Per box	m ² 13,96 kg 0,32 pce		m ² 13,96 kg 0,32 pce	
Pro Palette · Per pallet	3,12 m ² 43,57 kg 1 pce		3,12 m ² 43,57 kg 1 pce	
Mindestabgabereinheit · Min. sales unit	68,64 m ² 958,54 kg 22 box		68,64 m ² 958,54 kg 22 box	
Berechnungseinheit · Calculation unit	Stück · piece		Stück · piece	
Preisgruppe · Price group	m ²		m ²	
	P156		P156	

Für Wandanwendungen empfohlen.
 * Nur Längskante rektifiziert.
 Recommended for wall coverings.
 *only the long side of the tiles is rectified.

HUDSON Architektur Design (System) · Architecture Design (System)



120 x 120 cm

Artikelnummer · Article number
Warengruppe · Product group
Werksmaße · Dimensions (mm)
Farbe · Colour
Oberfläche · Finish
Erzeugnisgruppe
Material
Maßeinheit · Unit of measure
Pro Paket · Per box
Pro Palette · Per pallet
Mindestabgabeneinheit · Min. sales unit
Berechnungseinheit · Calculation unit
Preisgruppe · Price group

2961	OPTIMA 6 mm
SD1B	
Grundfliese · Basic tile	
1197 x 1197 x 6 mm	
white sand	
matt Sandstruktur · matt sand structure	VilbostonePlus
Feinsteinzeug	
Porcelain stoneware	
m ² 13,93 kg 0,69 pce	
2,88 m ² 40,12 kg 2 pce	
72 m ² 1003 kg 25 box	
P (box)	
m ²	
P134	



120 x 120 cm

2961	OPTIMA 6 mm
SD2B	
Grundfliese · Basic tile	
1197 x 1197 x 6 mm	
sand	
matt Sandstruktur · matt sand structure	VilbostonePlus
Feinsteinzeug	
Porcelain stoneware	
m ² 13,93 kg 0,69 pce	
2,88 m ² 40,12 kg 2 pce	
72 m ² 1003 kg 25 box	
P (box)	
m ²	
P134	



120 x 120 cm

2961	OPTIMA 6 mm
SD7B	
Grundfliese · Basic tile	
1197 x 1197 x 6 mm	
clay	
matt Sandstruktur · matt sand structure	VilbostonePlus
Feinsteinzeug	
Porcelain stoneware	
m ² 13,93 kg 0,69 pce	
2,88 m ² 40,12 kg 2 pce	
72 m ² 1003 kg 25 box	
P (box)	
m ²	
P134	



120 x 120 cm

2961	OPTIMA 6 mm
SD9B	
Grundfliese · Basic tile	
1197 x 1197 x 6 mm	
volcano	
matt Sandstruktur · matt sand structure	VilbostonePlus
Feinsteinzeug	
Porcelain stoneware	
m ² 13,93 kg 0,69 pce	
2,88 m ² 40,12 kg 2 pce	
72 m ² 1003 kg 25 box	
P (box)	
m ²	
P134	

HUDSON Architektur Design (System) · Architecture Design (System)



60 x 120 cm



60 x 120 cm



Artikelnummer · Article number	2960
Warengruppe · Product group	Grundfliese · Basic tile
Werksmaße · Dimensions (mm)	597 x 1197 x 6 mm
Farbe · Colour	white sand
Oberfläche · Finish	matt Sandstruktur · matt sand structure
Erzeugnisgruppe	Feinsteinzeug
Material	Porcelain stoneware
Maßeinheit · Unit of measure	m ² 13,89 kg 1,39 pce
Pro Paket · Per box	1,44 m ² 20 kg 2 pce
Pro Palette · Per pallet	72 m ² 1000 kg 50 box
Mindestabgabereinheit · Min. sales unit	P (box)
Berechnungseinheit · Calculation unit	m ²
Preisgruppe · Price group	P120

Artikelnummer · Article number	2960	OPTIMA 6 mm
Warengruppe · Product group	Grundfliese · Basic tile	
Werksmaße · Dimensions (mm)	597 x 1197 x 6 mm	
Farbe · Colour	white sand	
Oberfläche · Finish	matt Sandstruktur · matt sand structure	VilbostonePlus
Erzeugnisgruppe	Feinsteinzeug	
Material	Porcelain stoneware	
Maßeinheit · Unit of measure	m ² 13,89 kg 1,39 pce	
Pro Paket · Per box	1,44 m ² 20 kg 2 pce	
Pro Palette · Per pallet	72 m ² 1000 kg 50 box	
Mindestabgabereinheit · Min. sales unit	P (box)	
Berechnungseinheit · Calculation unit	m ²	
Preisgruppe · Price group	P120	

Artikelnummer · Article number	2960	OPTIMA 6 mm
Warengruppe · Product group	Grundfliese · Basic tile	
Werksmaße · Dimensions (mm)	597 x 1197 x 6 mm	
Farbe · Colour	sand	
Oberfläche · Finish	matt Sandstruktur · matt sand structure	VilbostonePlus
Erzeugnisgruppe	Feinsteinzeug	
Material	Porcelain stoneware	
Maßeinheit · Unit of measure	m ² 13,89 kg 1,39 pce	
Pro Paket · Per box	1,44 m ² 20 kg 2 pce	
Pro Palette · Per pallet	72 m ² 1000 kg 50 box	
Mindestabgabereinheit · Min. sales unit	P (box)	
Berechnungseinheit · Calculation unit	m ²	
Preisgruppe · Price group	P120	



60 x 120 cm



60 x 120 cm



Artikelnummer · Article number	2960
Warengruppe · Product group	Grundfliese · Basic tile
Werksmaße · Dimensions (mm)	597 x 1197 x 6 mm
Farbe · Colour	clay
Oberfläche · Finish	matt Sandstruktur · matt sand structure
Erzeugnisgruppe	Feinsteinzeug
Material	Porcelain stoneware
Maßeinheit · Unit of measure	m ² 13,89 kg 1,39 pce
Pro Paket · Per box	1,44 m ² 20 kg 2 pce
Pro Palette · Per pallet	72 m ² 1000 kg 50 box
Mindestabgabereinheit · Min. sales unit	P (box)
Berechnungseinheit · Calculation unit	m ²
Preisgruppe · Price group	P120

Artikelnummer · Article number	2960	OPTIMA 6 mm
Warengruppe · Product group	Grundfliese · Basic tile	
Werksmaße · Dimensions (mm)	597 x 1197 x 6 mm	
Farbe · Colour	clay	
Oberfläche · Finish	matt Sandstruktur · matt sand structure	VilbostonePlus
Erzeugnisgruppe	Feinsteinzeug	
Material	Porcelain stoneware	
Maßeinheit · Unit of measure	m ² 13,89 kg 1,39 pce	
Pro Paket · Per box	1,44 m ² 20 kg 2 pce	
Pro Palette · Per pallet	72 m ² 1000 kg 50 box	
Mindestabgabereinheit · Min. sales unit	P (box)	
Berechnungseinheit · Calculation unit	m ²	
Preisgruppe · Price group	P120	

Artikelnummer · Article number	2960	OPTIMA 6 mm
Warengruppe · Product group	Grundfliese · Basic tile	
Werksmaße · Dimensions (mm)	597 x 1197 x 6 mm	
Farbe · Colour	volcano	
Oberfläche · Finish	matt Sandstruktur · matt sand structure	VilbostonePlus
Erzeugnisgruppe	Feinsteinzeug	
Material	Porcelain stoneware	
Maßeinheit · Unit of measure	m ² 13,89 kg 1,39 pce	
Pro Paket · Per box	1,44 m ² 20 kg 2 pce	
Pro Palette · Per pallet	72 m ² 1000 kg 50 box	
Mindestabgabereinheit · Min. sales unit	P (box)	
Berechnungseinheit · Calculation unit	m ²	
Preisgruppe · Price group	P120	

HUDSON Architektur Design (System) · Architecture Design (System)



60 x 120 cm

Artikelnummer · Article number	2987
Warengruppe · Product group	Grundfliese · Basic tile
Werkgröße · Dimensions (mm)	597 x 1197 x 10 mm
Farbe · Colour	white sand
Oberfläche · Finish	matt Sandstruktur reliefiert · matt sand structure relief VilbostonePlus
Erzeugnisgruppe	Feinsteinzeug
Material	Porcelain stoneware
Maßeinheit · Unit of measure	m ² 21,28 kg 1,39 pce
Pro Paket · Per box	1,44 m ² 30,64 kg 2 pce
Pro Palette · Per pallet	43,2 m ² 919,2 kg 30 box
Mindestabgabereinheit · Min. sales unit	P (box)
Berechnungseinheit · Calculation unit	m ²
Preisgruppe · Price group	P110



60 x 120 cm

Artikelnummer · Article number	2987
Warengruppe · Product group	Grundfliese · Basic tile
Werkgröße · Dimensions (mm)	597 x 1197 x 10 mm
Farbe · Colour	sand
Oberfläche · Finish	matt Sandstruktur reliefiert · matt sand structure relief VilbostonePlus
Erzeugnisgruppe	Feinsteinzeug
Material	Porcelain stoneware
Maßeinheit · Unit of measure	m ² 21,28 kg 1,39 pce
Pro Paket · Per box	1,44 m ² 30,64 kg 2 pce
Pro Palette · Per pallet	43,2 m ² 919,2 kg 30 box
Mindestabgabereinheit · Min. sales unit	P (box)
Berechnungseinheit · Calculation unit	m ²
Preisgruppe · Price group	P110



60 x 120 cm

Artikelnummer · Article number	2987
Warengruppe · Product group	Grundfliese · Basic tile
Werkgröße · Dimensions (mm)	597 x 1197 x 10 mm
Farbe · Colour	clay
Oberfläche · Finish	matt Sandstruktur reliefiert · matt sand structure relief VilbostonePlus
Erzeugnisgruppe	Feinsteinzeug
Material	Porcelain stoneware
Maßeinheit · Unit of measure	m ² 21,28 kg 1,39 pce
Pro Paket · Per box	1,44 m ² 30,64 kg 2 pce
Pro Palette · Per pallet	43,2 m ² 919,2 kg 30 box
Mindestabgabereinheit · Min. sales unit	P (box)
Berechnungseinheit · Calculation unit	m ²
Preisgruppe · Price group	P110



60 x 120 cm

Artikelnummer · Article number	2987
Warengruppe · Product group	Grundfliese · Basic tile
Werkgröße · Dimensions (mm)	597 x 1197 x 10 mm
Farbe · Colour	volcano
Oberfläche · Finish	matt Sandstruktur reliefiert · matt sand structure relief VilbostonePlus
Erzeugnisgruppe	Feinsteinzeug
Material	Porcelain stoneware
Maßeinheit · Unit of measure	m ² 21,28 kg 1,39 pce
Pro Paket · Per box	1,44 m ² 30,64 kg 2 pce
Pro Palette · Per pallet	43,2 m ² 919,2 kg 30 box
Mindestabgabereinheit · Min. sales unit	P (box)
Berechnungseinheit · Calculation unit	m ²
Preisgruppe · Price group	P110



60 x 120 cm

Artikelnummer · Article number	2987
Warengruppe · Product group	Grundfliese · Basic tile
Werkgröße · Dimensions (mm)	597 x 1197 x 10 mm
Farbe · Colour	ash grey
Oberfläche · Finish	matt Sandstruktur reliefiert · matt sand structure relief VilbostonePlus
Erzeugnisgruppe	Feinsteinzeug
Material	Porcelain stoneware
Maßeinheit · Unit of measure	m ² 21,28 kg 1,39 pce
Pro Paket · Per box	1,44 m ² 30,64 kg 2 pce
Pro Palette · Per pallet	43,2 m ² 919,2 kg 30 box
Mindestabgabereinheit · Min. sales unit	P (box)
Berechnungseinheit · Calculation unit	m ²
Preisgruppe · Price group	P110



60 x 120 cm

Artikelnummer · Article number	2987
Warengruppe · Product group	Grundfliese · Basic tile
Werkgröße · Dimensions (mm)	597 x 1197 x 10 mm
Farbe · Colour	dark ash
Oberfläche · Finish	matt Sandstruktur reliefiert · matt sand structure relief VilbostonePlus
Erzeugnisgruppe	Feinsteinzeug
Material	Porcelain stoneware
Maßeinheit · Unit of measure	m ² 21,28 kg 1,39 pce
Pro Paket · Per box	1,44 m ² 30,64 kg 2 pce
Pro Palette · Per pallet	43,2 m ² 919,2 kg 30 box
Mindestabgabereinheit · Min. sales unit	P (box)
Berechnungseinheit · Calculation unit	m ²
Preisgruppe · Price group	P110



60 x 120 cm

Artikelnummer · Article number	2987
Warengruppe · Product group	Grundfliese · Basic tile
Werkgröße · Dimensions (mm)	597 x 1197 x 10 mm
Farbe · Colour	magma
Oberfläche · Finish	matt Sandstruktur reliefiert · matt sand structure relief VilbostonePlus
Erzeugnisgruppe	Feinsteinzeug
Material	Porcelain stoneware
Maßeinheit · Unit of measure	m ² 21,28 kg 1,39 pce
Pro Paket · Per box	1,44 m ² 30,64 kg 2 pce
Pro Palette · Per pallet	43,2 m ² 919,2 kg 30 box
Mindestabgabereinheit · Min. sales unit	P (box)
Berechnungseinheit · Calculation unit	m ²
Preisgruppe · Price group	P110



30 x 120 cm

Artikelnummer · Article number	2988
Warengruppe · Product group	Grundfliese · Basic tile
Werkgröße · Dimensions (mm)	297 x 1197 x 10 mm
Farbe · Colour	white sand
Oberfläche · Finish	matt Sandstruktur reliefiert · matt sand structure relief VilbostonePlus
Erzeugnisgruppe	Feinsteinzeug
Material	Porcelain stoneware
Maßeinheit · Unit of measure	m ² 22,22 kg 2,78 pce
Pro Paket · Per box	1,44 m ² 32 kg 4 pce
Pro Palette · Per pallet	43,20 m ² 960 kg 30 box
Mindestabgabereinheit · Min. sales unit	P (box)
Berechnungseinheit · Calculation unit	m ²
Preisgruppe · Price group	P124

HUDSON Architektur Design (System) · Architecture Design (System)

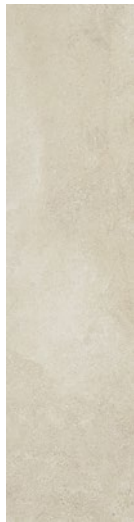

30 x 120 cm



30 x 120 cm



30 x 120 cm



30 x 120 cm









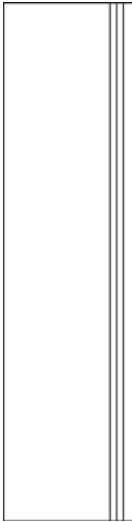

Artikelnummer · Article number	2988	2988	2988	2988
Warengruppe · Product group	SD2B	SD7B	SD9B	SD5B
Werksmaße · Dimensions (mm)	297 x 1197 x 10 mm	297 x 1197 x 10 mm	297 x 1197 x 10 mm	297 x 1197 x 10 mm
Farbe · Colour	sand	clay	volcano	ash grey
Oberfläche · Finish	matt Sandstruktur reliefiert · matt sand structure relief VilbostonePlus	matt Sandstruktur reliefiert · matt sand structure relief VilbostonePlus	matt Sandstruktur reliefiert · matt sand structure relief VilbostonePlus	matt Sandstruktur reliefiert · matt sand structure relief VilbostonePlus
Erzeugnisgruppe	Feinsteinzeug	Feinsteinzeug	Feinsteinzeug	Feinsteinzeug
Material	Porcelain stoneware	Porcelain stoneware	Porcelain stoneware	Porcelain stoneware
Maßeinheit · Unit of measure	m ² 22,22 kg 2,78 pce	m ² 22,22 kg 2,78 pce	m ² 22,22 kg 2,78 pce	m ² 22,22 kg 2,78 pce
Pro Paket · Per box	1,44 m ² 32 kg 4 pce	1,44 m ² 32 kg 4 pce	1,44 m ² 32 kg 4 pce	1,44 m ² 32 kg 4 pce
Pro Palette · Per pallet	43,20 m ² 960 kg 30 box	43,20 m ² 960 kg 30 box	43,20 m ² 960 kg 30 box	43,20 m ² 960 kg 30 box
Mindestabgabereinheit · Min. sales unit	P (box)	P (box)	P (box)	P (box)
Berechnungseinheit · Calculation unit	m ²	m ²	m ²	m ²
Preisgruppe · Price group	P124	P124	P124	P124

HUDSON

Architektur Design (System) · Architecture Design (System)



				
	30 x 120 cm	30 x 120 cm	30 x 120 cm	60 x 60 cm
Artikelnummer · Article number	2988	2988	2732	2577
	SD6B	SD8B	SD1B, SD2B, SD5B SD6B, SD7B, SD8B SD9B	SD1B
Warengruppe · Product group	Grundfliese · Basic tile	Grundfliese · Basic tile	Treppenauftritt · Stair tread	Grundfliese · Basic tile
Werkmaße · Dimensions (mm)	297 x 1197 x 10 mm	297 x 1197 x 10 mm	297 x 1197 x 10 mm	597 x 597 x 10 mm
Farbe · Colour	dark ash	magma	-	white sand
Oberfläche · Finish	matt Sandstruktur reliefiert · matt sand structure relief VilbostonePlus	matt Sandstruktur reliefiert · matt sand structure relief VilbostonePlus	matt Sandstruktur reliefiert · matt sand structure relief VilbostonePlus	matt Sandstruktur reliefiert · matt sand structure relief VilbostonePlus
Erzeugnisgruppe	Feinsteinzeug	Feinsteinzeug	Feinsteinzeug	Feinsteinzeug
Material	Porcelain stoneware	Porcelain stoneware	Porcelain stoneware	Porcelain stoneware
Maßeinheit · Unit of measure	m ² 22,22 kg 2,78 pce	m ² 22,22 kg 2,78 pce	m 6,64 kg 0,83 pce	m ² 22,22 kg 2,78 pce
Pro Paket · Per box	1,44 m ² 32 kg 4 pce	1,44 m ² 32 kg 4 pce	2,41 m 16 kg 2 pce	1,44 m ² 32 kg 4 pce
Pro Palette · Per pallet	43,20 m ² 960 kg 30 box	43,20 m ² 960 kg 30 box	106,02 m 704 kg 44 box	43,20 m ² 960 kg 30 box
Mindestabgabereinheit · Min. sales unit	P (box)	P (box)	E (pce)	P (box)
Berechnungseinheit · Calculation unit	m ²	m ²	Stück · piece	m ²
Preisgruppe · Price group	P124	P124	E118	P93
			Auftragsbezogene Fertigung der Treppen in der zu bestellten Grundfliese passenden Nuance. Lieferzeit auf Anfrage. Steps made to order in the nuance that matches the basic tile ordered. Delivery time on request.	
				
	60 x 60 cm	60 x 60 cm	60 x 60 cm	60 x 60 cm
Artikelnummer · Article number	2577	2577	2577	2577
	SD2B	SD7B	SD9B	SD5B
Warengruppe · Product group	Grundfliese · Basic tile	Grundfliese · Basic tile	Grundfliese · Basic tile	Grundfliese · Basic tile
Werkmaße · Dimensions (mm)	597 x 597 x 10 mm	597 x 597 x 10 mm	597 x 597 x 10 mm	597 x 597 x 10 mm
Farbe · Colour	sand	clay	volcano	ash grey
Oberfläche · Finish	matt Sandstruktur reliefiert · matt sand structure relief VilbostonePlus	matt Sandstruktur reliefiert · matt sand structure relief VilbostonePlus	matt Sandstruktur reliefiert · matt sand structure relief VilbostonePlus	matt Sandstruktur reliefiert · matt sand structure relief VilbostonePlus
Erzeugnisgruppe	Feinsteinzeug	Feinsteinzeug	Feinsteinzeug	Feinsteinzeug
Material	Porcelain stoneware	Porcelain stoneware	Porcelain stoneware	Porcelain stoneware
Maßeinheit · Unit of measure	m ² 22,22 kg 2,78 pce	m ² 22,22 kg 2,78 pce	m ² 22,22 kg 2,78 pce	m ² 22,22 kg 2,78 pce
Pro Paket · Per box	1,44 m ² 32 kg 4 pce	1,44 m ² 32 kg 4 pce	1,44 m ² 32 kg 4 pce	1,44 m ² 32 kg 4 pce
Pro Palette · Per pallet	43,20 m ² 960 kg 30 box	43,20 m ² 960 kg 30 box	43,20 m ² 960 kg 30 box	43,20 m ² 960 kg 30 box
Mindestabgabereinheit · Min. sales unit	P (box)	P (box)	P (box)	P (box)
Berechnungseinheit · Calculation unit	m ²	m ²	m ²	m ²
Preisgruppe · Price group	P93	P93	P93	P93

HUDSON

Architektur Design (System) · Architecture Design (System)



	60 x 60 cm	60 x 60 cm	60 x 60 cm	60 x 60 cm
Artikelnummer · Article number	2577	2577	2577	2577
	SD6B	SD8B	SD1L, SD2L, SD5L SD6L, SD7L, SD8L SD9L	SD1M, SD2M, SD5M SD6M, SD7M, SD8M SD9M
Warengruppe · Product group	Grundfliese · Basic tile	Grundfliese · Basic tile	Grundfliese · Basic tile	Grundfliese · Basic tile
Werksmaße · Dimensions (mm)	597 x 597 x 10 mm	597 x 597 x 10 mm	597 x 597 x 10 mm	597 x 597 x 10 mm
Farbe · Colour	dark ash	magma	-	-
Oberfläche · Finish	matt Sandstruktur reliefiert · matt sand structure relief VilbostonePlus	matt Sandstruktur reliefiert · matt sand structure relief VilbostonePlus	geläpft/anpoliert Sandstruktur · rough-polished sand structure VilbostonePlus	matt Sandstruktur reliefiert · matt sand structure relief VilbostonePlus
Erzeugnisgruppe	Feinsteinzeug	Feinsteinzeug	Feinsteinzeug	Feinsteinzeug
Material	Porcelain stoneware	Porcelain stoneware	Porcelain stoneware	Porcelain stoneware
Maßeinheit · Unit of measure	m ² 22,22 kg 2,78 pce	m ² 22,22 kg 2,78 pce	m ² 22,22 kg 2,78 pce	m ² 22,22 kg 2,78 pce
Pro Paket · Per box	1,44 m ² 32 kg 4 pce	1,44 m ² 32 kg 4 pce	1,44 m ² 32 kg 4 pce	1,44 m ² 32 kg 4 pce
Pro Palette · Per pallet	43,20 m ² 960 kg 30 box	43,20 m ² 960 kg 30 box	43,20 m ² 960 kg 30 box	43,20 m ² 960 kg 30 box
Mindestabgabeneinheit · Min. sales unit	P (box)	P (box)	P (box)	P (box)
Berechnungseinheit · Calculation unit	m ²	m ²	m ²	m ²
Preisgruppe · Price group	P93	P93	P105	P93
	30 x 60 cm	30 x 60 cm	30 x 60 cm	30 x 60 cm
Artikelnummer · Article number	2576	2576	2576	2576
	SD1B	SD2B	SD7B	SD9B
Warengruppe · Product group	Grundfliese · Basic tile	Grundfliese · Basic tile	Grundfliese · Basic tile	Grundfliese · Basic tile
Werksmaße · Dimensions (mm)	297 x 597 x 10 mm	297 x 597 x 10 mm	297 x 597 x 10 mm	297 x 597 x 10 mm
Farbe · Colour	white sand	sand	clay	volcano
Oberfläche · Finish	matt Sandstruktur reliefiert · matt sand structure relief VilbostonePlus	matt Sandstruktur reliefiert · matt sand structure relief VilbostonePlus	matt Sandstruktur reliefiert · matt sand structure relief VilbostonePlus	matt Sandstruktur reliefiert · matt sand structure relief VilbostonePlus
Erzeugnisgruppe	Feinsteinzeug	Feinsteinzeug	Feinsteinzeug	Feinsteinzeug
Material	Porcelain stoneware	Porcelain stoneware	Porcelain stoneware	Porcelain stoneware
Maßeinheit · Unit of measure	m ² 21,22 kg 5,56 pce	m ² 21,22 kg 5,56 pce	m ² 21,22 kg 5,56 pce	m ² 21,22 kg 5,56 pce
Pro Paket · Per box	1,08 m ² 22,92 kg 6 pce	1,08 m ² 22,92 kg 6 pce	1,08 m ² 22,92 kg 6 pce	1,08 m ² 22,92 kg 6 pce
Pro Palette · Per pallet	43,2 m ² 916,80 kg 40 box	43,2 m ² 916,80 kg 40 box	43,2 m ² 916,80 kg 40 box	43,2 m ² 916,80 kg 40 box
Mindestabgabeneinheit · Min. sales unit	P (box)	P (box)	P (box)	P (box)
Berechnungseinheit · Calculation unit	m ²	m ²	m ²	m ²
Preisgruppe · Price group	P87	P87	P87	P87
	30 x 60 cm	30 x 60 cm	30 x 60 cm	30 x 60 cm
Artikelnummer · Article number	2576	2576	2576	2576
	SD5B	SD6B	SD8B	SD1L, SD2L, SD5L SD6L, SD7L, SD8L SD9L
Warengruppe · Product group	Grundfliese · Basic tile	Grundfliese · Basic tile	Grundfliese · Basic tile	Grundfliese · Basic tile
Werksmaße · Dimensions (mm)	297 x 597 x 10 mm	297 x 597 x 10 mm	297 x 597 x 10 mm	297 x 597 x 10 mm
Farbe · Colour	ash grey	dark ash	magma	-
Oberfläche · Finish	matt Sandstruktur reliefiert · matt sand structure relief VilbostonePlus	matt Sandstruktur reliefiert · matt sand structure relief VilbostonePlus	matt Sandstruktur reliefiert · matt sand structure relief VilbostonePlus	geläpft/anpoliert Sandstruktur · rough-polished sand structure VilbostonePlus
Erzeugnisgruppe	Feinsteinzeug	Feinsteinzeug	Feinsteinzeug	Feinsteinzeug
Material	Porcelain stoneware	Porcelain stoneware	Porcelain stoneware	Porcelain stoneware
Maßeinheit · Unit of measure	m ² 21,22 kg 5,56 pce	m ² 21,22 kg 5,56 pce	m ² 21,22 kg 5,56 pce	m ² 21,22 kg 5,56 pce
Pro Paket · Per box	1,08 m ² 22,92 kg 6 pce	1,08 m ² 22,92 kg 6 pce	1,08 m ² 22,92 kg 6 pce	1,08 m ² 22,92 kg 6 pce
Pro Palette · Per pallet	43,2 m ² 916,80 kg 40 box	43,2 m ² 916,80 kg 40 box	43,2 m ² 916,80 kg 40 box	43,2 m ² 916,80 kg 40 box
Mindestabgabeneinheit · Min. sales unit	P (box)	P (box)	P (box)	P (box)
Berechnungseinheit · Calculation unit	m ²	m ²	m ²	m ²
Preisgruppe · Price group	P87	P87	P87	P99

HUDSON

Architektur Design (System) · Architecture Design (System)









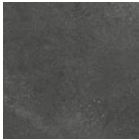
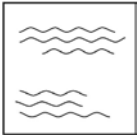

30 x 60 cm	30 x 60 cm	30 x 30 cm	30 x 30 cm
2576	2526	2575	2575
SD1M, SD2M, SD5M SD6M, SD7M, SD8M SD9M	SD1R, SD2R, SD5R SD6R, SD7R, SD8R SD9R	SD1M	SD2M
Grundfliese · Basic tile	Grundfliese · Basic tile	Grundfliese · Basic tile	Grundfliese · Basic tile
297 x 597 x 10 mm	297 x 597 x 10 mm	297 x 297 x 10 mm	297 x 297 x 10 mm
-	-	white sand	sand
matt Sandstruktur reliefiert · matt sand structure relief	matt Sandstruktur reliefiert · matt sand structure relief	matt Sandstruktur reliefiert · matt sand structure relief	matt Sandstruktur reliefiert · matt sand structure relief
VilbostonePlus	VilbostonePlus	VilbostonePlus	VilbostonePlus
Feinsteinzeug	Feinsteinzeug	Feinsteinzeug	Feinsteinzeug
Porcelain stoneware	Porcelain stoneware	Porcelain stoneware	Porcelain stoneware
m ² 21,22 kg 5,56 pce	m ² 21,22 kg 5,56 pce	m ² 22 kg 11 pce	m ² 22 kg 11 pce
1,08 m ² 22,92 kg 6 pce	1,08 m ² 22,92 kg 6 pce	1 m ² 22 kg 11 pce	1 m ² 22 kg 11 pce
43,2 m ² 916,80 kg 40 box	43,2 m ² 916,80 kg 40 box	48 m ² 1056 kg 48 box	48 m ² 1056 kg 48 box
P (box)	P (box)	P (box)	P (box)
m ²	m ²	m ²	m ²
P87	P87	P105	P105
Auftragsbezogene Fertigung, Mindestbestellmenge 100 m ² . Lieferzeit auf Anfrage. Custom-made production. Minimum order quantity 100 m ² . Delivery time on request.			
30 x 30 cm	30 x 30 cm	30 x 30 cm	30 x 30 cm
2575	2575	2575	2575
SD7M	SD9M	SD5M	SD6M
Grundfliese · Basic tile	Grundfliese · Basic tile	Grundfliese · Basic tile	Grundfliese · Basic tile
297 x 297 x 10 mm	297 x 297 x 10 mm	297 x 297 x 10 mm	297 x 297 x 10 mm
clay	volcano	ash grey	dark ash
matt Sandstruktur reliefiert · matt sand structure relief	matt Sandstruktur reliefiert · matt sand structure relief	matt Sandstruktur reliefiert · matt sand structure relief	matt Sandstruktur reliefiert · matt sand structure relief
VilbostonePlus	VilbostonePlus	VilbostonePlus	VilbostonePlus
Feinsteinzeug	Feinsteinzeug	Feinsteinzeug	Feinsteinzeug
Porcelain stoneware	Porcelain stoneware	Porcelain stoneware	Porcelain stoneware
m ² 22 kg 11 pce	m ² 22 kg 11 pce	m ² 22 kg 11 pce	m ² 22 kg 11 pce
1 m ² 22 kg 11 pce	1 m ² 22 kg 11 pce	1 m ² 22 kg 11 pce	1 m ² 22 kg 11 pce
48 m ² 1056 kg 48 box	48 m ² 1056 kg 48 box	48 m ² 1056 kg 48 box	48 m ² 1056 kg 48 box
P (box)	P (box)	P (box)	P (box)
m ²	m ²	m ²	m ²
P105	P105	P105	P105
Auftragsbezogene Fertigung, Mindestbestellmenge 100 m ² . Lieferzeit auf Anfrage. Custom-made production. Minimum order quantity 100 m ² . Delivery time on request.			

HUDSON

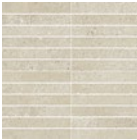
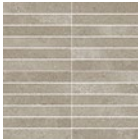
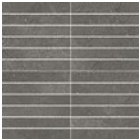
Architektur Design (System) · Architecture Design (System)

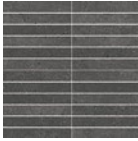







				
	30 x 30 cm	30 x 30 cm	15 x 60 cm	7,5 x 60 cm
Artikelnummer · Article number	2575	2525	2419	2852
Warengruppe · Product group	SD8M	SD1R, SD2R, SD5R SD6R, SD7R, SD8R SD9R	SD1B, SD2B, SD5B SD6B, SD7B, SD8B SD9B	SD1B, SD2B, SD5B SD6B, SD7B, SD8B SD9B
Werkmaße · Dimensions (mm)	297 x 297 x 10 mm	297 x 297 x 10 mm	147 x 597 x 10 mm	72 x 597 x 10 mm
Farbe · Colour	magma	-	-	-
Oberfläche · Finish	matt Sandstruktur reliefiert · matt sand structure relief VilbostonePlus	matt Sandstruktur reliefiert · matt sand structure relief VilbostonePlus	matt Sandstruktur reliefiert · matt sand structure relief VilbostonePlus	matt Sandstruktur reliefiert · matt sand structure relief VilbostonePlus
Erzeugnisgruppe	Feinsteinzeug	Feinsteinzeug	Feinsteinzeug	Feinsteinzeug
Material	Porcelain stoneware	Porcelain stoneware	Porcelain stoneware	Porcelain stoneware
Maßeinheit · Unit of measure	m ² 22 kg 11 pce	m ² 22 kg 11 pce	m ² 21,67 kg 11,11 pce	m ² 22,22 kg 22,22 pce
Pro Paket · Per box	1 m ² 22 kg 11 pce	1 m ² 22 kg 11 pce	0,90 m ² 19,50 kg 10 pce	0,90 m ² 20 kg 20 pce
Pro Palette · Per pallet	48 m ² 1056 kg 48 box	48 m ² 1056 kg 48 box	43,20 m ² 936 kg 48 box	43,20 m ² 960 kg 48 box
Mindestabgabeneinheit · Min. sales unit	P (box)	P (box)	P (box)	P (box)
Berechnungseinheit · Calculation unit	m ²	m ²	m ²	m ²
Preisgruppe · Price group	P105	P105	P132	P132
	Auftragsbezogene Fertigung. Mindestbestellmenge 100 m ² . Lieferzeit auf Anfrage. Custom-made production. Minimum order quantity 100 m ² . Delivery time on request.			
				
	2,5 x 15 cm	2,5 x 15 cm	2,5 x 15 cm	2,5 x 15 cm
	0,09 m ² 298 x 298 mm	0,09 m ² 298 x 298 mm	0,09 m ² 298 x 298 mm	0,09 m ² 298 x 298 mm
Artikelnummer · Article number	2135	2135	2135	2135
Warengruppe · Product group	SD1B	SD2B	SD7B	SD9B
Werkmaße · Dimensions (mm)	23 x 148 x 10 mm	23 x 148 x 10 mm	23 x 148 x 10 mm	23 x 148 x 10 mm
Farbe · Colour	white sand	sand	clay	volcano
Oberfläche · Finish	matt Sandstruktur reliefiert · matt sand structure relief VilbostonePlus	matt Sandstruktur reliefiert · matt sand structure relief VilbostonePlus	matt Sandstruktur reliefiert · matt sand structure relief VilbostonePlus	matt Sandstruktur reliefiert · matt sand structure relief VilbostonePlus
Erzeugnisgruppe	Feinsteinzeug	Feinsteinzeug	Feinsteinzeug	Feinsteinzeug
Material	Porcelain stoneware	Porcelain stoneware	Porcelain stoneware	Porcelain stoneware
Maßeinheit · Unit of measure	m ² 22 kg 11 pce	m ² 22 kg 11 pce	m ² 22 kg 11 pce	m ² 22 kg 11 pce
Pro Paket · Per box	1 m ² 22 kg 11 pce	1 m ² 22 kg 11 pce	1 m ² 22 kg 11 pce	1 m ² 22 kg 11 pce
Pro Palette · Per pallet	36 m ² 792 kg 36 box	36 m ² 792 kg 36 box	36 m ² 792 kg 36 box	36 m ² 792 kg 36 box
Mindestabgabeneinheit · Min. sales unit	P (box)	P (box)	P (box)	P (box)
Berechnungseinheit · Calculation unit	m ²	m ²	m ²	m ²
Preisgruppe · Price group	P178	P178	P178	P178
				
	2,5 x 15 cm	2,5 x 15 cm	2,5 x 15 cm	7,5 x 7,5 cm
	0,09 m ² 298 x 298 mm	0,09 m ² 297 x 297 mm	0,09 m ² 297 x 297 mm	0,09 m ² 297 x 297 mm
Artikelnummer · Article number	2135	2135	2135	2013
Warengruppe · Product group	SD5B	SD6B	SD8B	SD1B
Werkmaße · Dimensions (mm)	23 x 148 x 10 mm	23 x 148 x 10 mm	23 x 148 x 10 mm	72 x 72 x 10 mm
Farbe · Colour	ash grey	dark ash	magma	white sand
Oberfläche · Finish	matt Sandstruktur reliefiert · matt sand structure relief VilbostonePlus	matt Sandstruktur reliefiert · matt sand structure relief VilbostonePlus	matt Sandstruktur reliefiert · matt sand structure relief VilbostonePlus	matt Sandstruktur reliefiert · matt sand structure relief VilbostonePlus
Erzeugnisgruppe	Feinsteinzeug	Feinsteinzeug	Feinsteinzeug	Feinsteinzeug
Material	Porcelain stoneware	Porcelain stoneware	Porcelain stoneware	Porcelain stoneware
Maßeinheit · Unit of measure	m ² 22 kg 11 pce	m ² 22 kg 11 pce	m ² 22 kg 11 pce	m ² 20,90 kg 11 pce
Pro Paket · Per box	1 m ² 22 kg 11 pce	1 m ² 22 kg 11 pce	1 m ² 22 kg 11 pce	1 m ² 20,90 kg 11 pce
Pro Palette · Per pallet	36 m ² 792 kg 36 box	36 m ² 792 kg 36 box	36 m ² 792 kg 36 box	36 m ² 752,40 kg 36 box
Mindestabgabeneinheit · Min. sales unit	P (box)	P (box)	P (box)	P (box)
Berechnungseinheit · Calculation unit	m ²	m ²	m ²	m ²
Preisgruppe · Price group	P178	P178	P178	P168

HUDSON

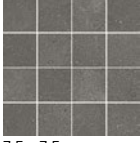
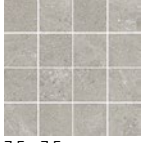
Architektur Design (System) · Architecture Design (System)

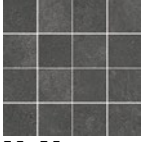
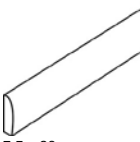

				
	7,5 x 7,5 cm	7,5 x 7,5 cm	7,5 x 7,5 cm	7,5 x 7,5 cm
	□ 0,09 m ² 297 x 297 mm	□ 0,09 m ² 297 x 297 mm	□ 0,09 m ² 297 x 297 mm	□ 0,09 m ² 297 x 297 mm
Artikelnummer · Article number	2013	2013	2013	2013
Warengruppe · Product group	SD2B	SD7B	SD9B	SD5B
Werkmaße · Dimensions (mm)	72 x 72 x 10 mm	72 x 72 x 10 mm	72 x 72 x 10 mm	72 x 72 x 10 mm
Farbe · Colour	sand	clay	volcano	ash grey
Oberfläche · Finish	matt Sandstruktur reliefiert · matt sand structure relief VilbostonePlus	matt Sandstruktur reliefiert · matt sand structure relief VilbostonePlus	matt Sandstruktur reliefiert · matt sand structure relief VilbostonePlus	matt Sandstruktur reliefiert · matt sand structure relief VilbostonePlus
Erzeugnisgruppe	Feinsteinzeug	Feinsteinzeug	Feinsteinzeug	Feinsteinzeug
Material	Porcelain stoneware	Porcelain stoneware	Porcelain stoneware	Porcelain stoneware
Maßeinheit · Unit of measure	m ² 20,90 kg 11 pce	m ² 20,90 kg 11 pce	m ² 20,90 kg 11 pce	m ² 20,90 kg 11 pce
Pro Paket · Per box	1 m ² 20,90 kg 11 pce	1 m ² 20,90 kg 11 pce	1 m ² 20,90 kg 11 pce	1 m ² 20,90 kg 11 pce
Pro Palette · Per pallet	36 m ² 752,40 kg 36 box	36 m ² 752,40 kg 36 box	36 m ² 752,40 kg 36 box	36 m ² 752,40 kg 36 box
Mindestabgabeneinheit · Min. sales unit	P (box)	P (box)	P (box)	P (box)
Berechnungseinheit · Calculation unit	m ²	m ²	m ²	m ²
Preisgruppe · Price group	P168	P168	P168	P168
				
	7,5 x 7,5 cm	7,5 x 7,5 cm	7,5 x 60 cm	10 x 30 cm
	□ 0,09 m ² 297 x 297 mm	□ 0,09 m ² 297 x 297 mm		
Artikelnummer · Article number	2013	2013	2872	2493
Warengruppe · Product group	SD6B	SD8B	SD1B, SD2B, SD5B SD6B, SD7B, SD8B SD9B	SD1B, SD2B, SD5B SD6B, SD7B, SD8B SD9B
Werkmaße · Dimensions (mm)	72 x 72 x 10 mm	72 x 72 x 10 mm	72 x 597 x 10 mm	107 x 297 x 9 mm
Farbe · Colour	dark ash	magma	-	-
Oberfläche · Finish	matt Sandstruktur reliefiert · matt sand structure relief VilbostonePlus	matt Sandstruktur reliefiert · matt sand structure relief VilbostonePlus	matt Sandstruktur reliefiert · matt sand structure relief VilbostonePlus	matt Sandstruktur reliefiert · matt sand structure relief VilbostonePlus
Erzeugnisgruppe	Feinsteinzeug	Feinsteinzeug	Feinsteinzeug	Feinsteinzeug
Material	Porcelain stoneware	Porcelain stoneware	Porcelain stoneware	Porcelain stoneware
Maßeinheit · Unit of measure	m ² 20,90 kg 11 pce	m ² 20,90 kg 11 pce	m 1,67 kg 1,67 pce	m 1,67 kg 3,33 pce
Pro Paket · Per box	1 m ² 20,90 kg 11 pce	1 m ² 20,90 kg 11 pce	11,98 m 20 kg 20 pce	6,01 m 10 kg 20 pce
Pro Palette · Per pallet	36 m ² 752,40 kg 36 box	36 m ² 752,40 kg 36 box	574,85 m 960 kg 48 box	420,42 m 700 kg 70 box
Mindestabgabeneinheit · Min. sales unit	P (box)	P (box)	E (pce)	E (pce)
Berechnungseinheit · Calculation unit	m ²	m ²	Stück · piece	Stück · piece
Preisgruppe · Price group	P168	P168	E51	E47

LOBBY

Architektur Design (Basis) · Architecture Design (Basis)

30 x 60 cm	30 x 60 cm	30 x 60 cm	30 x 60 cm
2360	2360	2360	2360
L010	L020	L070	L060
Grundfliese · Basic tile	Grundfliese · Basic tile	Grundfliese · Basic tile	Grundfliese · Basic tile
Werkmaße · Dimensions (mm)	Werkmaße · Dimensions (mm)	Werkmaße · Dimensions (mm)	Werkmaße · Dimensions (mm)
297 x 597 x 10 mm	297 x 597 x 10 mm	297 x 597 x 10 mm	297 x 597 x 10 mm
Farbe · Colour	Farbe · Colour	Farbe · Colour	Farbe · Colour
creme	beige	greige	grey
Oberfläche · Finish	Oberfläche · Finish	Oberfläche · Finish	Oberfläche · Finish
matt reliefiert · matt relief	matt reliefiert · matt relief	matt reliefiert · matt relief	matt reliefiert · matt relief
Erzeugnisgruppe	Erzeugnisgruppe	Erzeugnisgruppe	Erzeugnisgruppe
Feinsteinzeug	Feinsteinzeug	Feinsteinzeug	Feinsteinzeug
Material	Material	Material	Material
Porcelain stoneware	Porcelain stoneware	Porcelain stoneware	Porcelain stoneware
Maßeinheit · Unit of measure	Maßeinheit · Unit of measure	Maßeinheit · Unit of measure	Maßeinheit · Unit of measure
m ² 22,22 kg 5,56 pce	m ² 22,22 kg 5,56 pce	m ² 22,22 kg 5,56 pce	m ² 22,22 kg 5,56 pce
Pro Paket · Per box	Pro Paket · Per box	Pro Paket · Per box	Pro Paket · Per box
1,08 m ² 24 kg 6 pce	1,08 m ² 24 kg 6 pce	1,08 m ² 24 kg 6 pce	1,08 m ² 24 kg 6 pce
Pro Palette · Per pallet	Pro Palette · Per pallet	Pro Palette · Per pallet	Pro Palette · Per pallet
43,20 m ² 960 kg 40 box	43,20 m ² 960 kg 40 box	43,20 m ² 960 kg 40 box	43,20 m ² 960 kg 40 box
Mindestabgabeneinheit · Min. sales unit	Mindestabgabeneinheit · Min. sales unit	Mindestabgabeneinheit · Min. sales unit	Mindestabgabeneinheit · Min. sales unit
P (box)	P (box)	P (box)	P (box)
Berechnungseinheit · Calculation unit	Berechnungseinheit · Calculation unit	Berechnungseinheit · Calculation unit	Berechnungseinheit · Calculation unit
m ²	m ²	m ²	m ²
Preisgruppe · Price group	Preisgruppe · Price group	Preisgruppe · Price group	Preisgruppe · Price group
P92	P92	P92	P92
30 x 60 cm	30 x 60 cm	5 x 5 cm	5 x 5 cm
2360	2360	2706	2706
L061	L090	L010	L020
Grundfliese · Basic tile	Grundfliese · Basic tile	Grundfliese · Basic tile	Grundfliese · Basic tile
Werkmaße · Dimensions (mm)	Werkmaße · Dimensions (mm)	Werkmaße · Dimensions (mm)	Werkmaße · Dimensions (mm)
297 x 597 x 10 mm	297 x 597 x 10 mm	48 x 48 x 6 mm	48 x 48 x 6 mm
Farbe · Colour	Farbe · Colour	Farbe · Colour	Farbe · Colour
dark grey	anthracite	creme	beige
Oberfläche · Finish	Oberfläche · Finish	Oberfläche · Finish	Oberfläche · Finish
matt reliefiert · matt relief	matt reliefiert · matt relief	matt reliefiert · matt relief	matt reliefiert · matt relief
Erzeugnisgruppe	Erzeugnisgruppe	Erzeugnisgruppe	Erzeugnisgruppe
Feinsteinzeug	Feinsteinzeug	Feinsteinzeug glasiert	Feinsteinzeug glasiert
Material	Material	Material	Material
Porcelain stoneware	Porcelain stoneware	Glazed porcelain stoneware	Glazed porcelain stoneware
Maßeinheit · Unit of measure	Maßeinheit · Unit of measure	Maßeinheit · Unit of measure	Maßeinheit · Unit of measure
m ² 22,22 kg 5,56 pce	m ² 22,22 kg 5,56 pce	m ² 11,77 kg 11 pce	m ² 11,77 kg 11 pce
Pro Paket · Per box	Pro Paket · Per box	Pro Paket · Per box	Pro Paket · Per box
1,08 m ² 24 kg 6 pce	1,08 m ² 24 kg 6 pce	1 m ² 11,77 kg 11 pce	1 m ² 11,77 kg 11 pce
Pro Palette · Per pallet	Pro Palette · Per pallet	Pro Palette · Per pallet	Pro Palette · Per pallet
43,20 m ² 960 kg 40 box	43,20 m ² 960 kg 40 box	78 m ² 918,06 kg 78 box	78 m ² 918,06 kg 78 box
Mindestabgabeneinheit · Min. sales unit	Mindestabgabeneinheit · Min. sales unit	Mindestabgabeneinheit · Min. sales unit	Mindestabgabeneinheit · Min. sales unit
P (box)	P (box)	P (box)	P (box)
Berechnungseinheit · Calculation unit	Berechnungseinheit · Calculation unit	Berechnungseinheit · Calculation unit	Berechnungseinheit · Calculation unit
m ²	m ²	m ²	m ²
Preisgruppe · Price group	Preisgruppe · Price group	Preisgruppe · Price group	Preisgruppe · Price group
P92	P92	P117	P117
5 x 5 cm	5 x 5 cm	5 x 5 cm	5 x 5 cm
2706	2706	2706	2706
L070	L060	L061	L090
Grundfliese · Basic tile	Grundfliese · Basic tile	Grundfliese · Basic tile	Grundfliese · Basic tile
Werkmaße · Dimensions (mm)	Werkmaße · Dimensions (mm)	Werkmaße · Dimensions (mm)	Werkmaße · Dimensions (mm)
48 x 48 x 6 mm	48 x 48 x 6 mm	48 x 48 x 6 mm	48 x 48 x 6 mm
Farbe · Colour	Farbe · Colour	Farbe · Colour	Farbe · Colour
greige	grey	dark grey	anthracite
Oberfläche · Finish	Oberfläche · Finish	Oberfläche · Finish	Oberfläche · Finish
matt reliefiert · matt relief	matt reliefiert · matt relief	matt reliefiert · matt relief	matt reliefiert · matt relief
Erzeugnisgruppe	Erzeugnisgruppe	Erzeugnisgruppe	Erzeugnisgruppe
Feinsteinzeug glasiert	Feinsteinzeug glasiert	Feinsteinzeug glasiert	Feinsteinzeug glasiert
Material	Material	Material	Material
Glazed porcelain stoneware	Glazed porcelain stoneware	Glazed porcelain stoneware	Glazed porcelain stoneware
Maßeinheit · Unit of measure	Maßeinheit · Unit of measure	Maßeinheit · Unit of measure	Maßeinheit · Unit of measure
m ² 11,77 kg 11 pce	m ² 11,77 kg 11 pce	m ² 11,77 kg 11 pce	m ² 11,77 kg 11 pce
Pro Paket · Per box	Pro Paket · Per box	Pro Paket · Per box	Pro Paket · Per box
1 m ² 11,77 kg 11 pce	1 m ² 11,77 kg 11 pce	1 m ² 11,77 kg 11 pce	1 m ² 11,77 kg 11 pce
Pro Palette · Per pallet	Pro Palette · Per pallet	Pro Palette · Per pallet	Pro Palette · Per pallet
78 m ² 918,06 kg 78 box	78 m ² 918,06 kg 78 box	78 m ² 918,06 kg 78 box	78 m ² 918,06 kg 78 box
Mindestabgabeneinheit · Min. sales unit	Mindestabgabeneinheit · Min. sales unit	Mindestabgabeneinheit · Min. sales unit	Mindestabgabeneinheit · Min. sales unit
P (box)	P (box)	P (box)	P (box)
Berechnungseinheit · Calculation unit	Berechnungseinheit · Calculation unit	Berechnungseinheit · Calculation unit	Berechnungseinheit · Calculation unit
m ²	m ²	m ²	m ²
Preisgruppe · Price group	Preisgruppe · Price group	Preisgruppe · Price group	Preisgruppe · Price group
P117	P117	P117	P117

OHIO Architektur Design (Basis) · Architecture Design (Basis)

Concept³

	30 x 60 cm NEW 2023	30 x 60 cm NEW 2023	60 x 60 cm NEW 2023	60 x 60 cm NEW 2023
Artikelnummer · Article number	1571	1571	2310	2310
Warengruppe · Product group	CJ10	CJ60	CJ10	CJ20
Werkmaße · Dimensions (mm)	297 x 597 x 9 mm	297 x 597 x 9 mm	597 x 597 x 9 mm	597 x 597 x 9 mm
Farbe · Colour	creme	light grey	creme	beige
Oberfläche · Finish	matt Dezente Betonoptik · matt Subtle concrete look CeramicPlus	matt Dezente Betonoptik · matt Subtle concrete look CeramicPlus	matt Dezente Betonoptik · matt Subtle concrete look VilbostonePlus	matt Dezente Betonoptik · matt Subtle concrete look VilbostonePlus
Erzeugnisgruppe	Steingut	Steingut	Feinsteinzeug	Feinsteinzeug
Material	Nonvitreous	Nonvitreous	Porcelain stoneware	Porcelain stoneware
Maßeinheit · Unit of measure	m ² 15,56 kg 5,56 pce	m ² 15,56 kg 5,56 pce	m ² 22,22 kg 2,78 pce	m ² 22,22 kg 2,78 pce
Pro Paket · Per box	1,08 m ² 16,80 kg 6 pce	1,08 m ² 16,80 kg 6 pce	1,44 m ² 32 kg 4 pce	1,44 m ² 32 kg 4 pce
Pro Palette · Per pallet	51,84 m ² 806,40 kg 48 box	51,84 m ² 806,40 kg 48 box	43,20 m ² 960 kg 30 box	43,20 m ² 960 kg 30 box
Mindestabgabeneinheit · Min. sales unit	P (box)	P (box)	P (box)	P (box)
Berechnungseinheit · Calculation unit	m ²	m ²	m ²	m ²
Preisgruppe · Price group	P65	P65	P74	P74
	60 x 60 cm NEW 2023	60 x 60 cm NEW 2023	60 x 60 cm NEW 2023	45 x 45 cm NEW 2023
Artikelnummer · Article number	2310	2310	2310	2733
Warengruppe · Product group	CJ60	CJ61	CJ62	CJ10, CJ20, CJ60 CJ61, CJ62
Werkmaße · Dimensions (mm)	597 x 597 x 9 mm	597 x 597 x 9 mm	597 x 597 x 9 mm	447 x 447 x 9 mm
Farbe · Colour	light grey	grey	dark grey	-
Oberfläche · Finish	matt Dezente Betonoptik · matt Subtle concrete look VilbostonePlus	matt Dezente Betonoptik · matt Subtle concrete look VilbostonePlus	matt Dezente Betonoptik · matt Subtle concrete look VilbostonePlus	matt Dezente Betonoptik · matt Subtle concrete look VilbostonePlus
Erzeugnisgruppe	Feinsteinzeug	Feinsteinzeug	Feinsteinzeug	Feinsteinzeug
Material	Porcelain stoneware	Porcelain stoneware	Porcelain stoneware	Porcelain stoneware
Maßeinheit · Unit of measure	m ² 22,22 kg 2,78 pce	m ² 22,22 kg 2,78 pce	m ² 22,22 kg 2,78 pce	m ² 19,75 kg 4,94 pce
Pro Paket · Per box	1,44 m ² 32 kg 4 pce	1,44 m ² 32 kg 4 pce	1,44 m ² 32 kg 4 pce	1,42 m ² 28 kg 7 pce
Pro Palette · Per pallet	43,20 m ² 960 kg 30 box	43,20 m ² 960 kg 30 box	43,20 m ² 960 kg 30 box	36,86 m ² 728 kg 26 box
Mindestabgabeneinheit · Min. sales unit	P (box)	P (box)	P (box)	P (box)
Berechnungseinheit · Calculation unit	m ²	m ²	m ²	m ²
Preisgruppe · Price group	P74	P74	P74	P63

OHIO Architektur Design (Basis) · Architecture Design (Basis)

Concept³

	30 x 60 cm NEW 2023	30 x 60 cm NEW 2023	30 x 60 cm NEW 2023	30 x 60 cm NEW 2023
Artikelnummer · Article number	2685 CJ10	2685 CJ20	2685 CJ60	2685 CJ61
Warengruppe · Product group	Grundfliese · Basic tile	Grundfliese · Basic tile	Grundfliese · Basic tile	Grundfliese · Basic tile
Werksmaße · Dimensions (mm)	297 x 597 x 9 mm	297 x 597 x 9 mm	297 x 597 x 9 mm	297 x 597 x 9 mm
Farbe · Colour	creme	beige	light grey	grey
Oberfläche · Finish	matt Dezente Betonoptik · matt Subtle concrete look VilbostonePlus	matt Dezente Betonoptik · matt Subtle concrete look VilbostonePlus	matt Dezente Betonoptik · matt Subtle concrete look VilbostonePlus	matt Dezente Betonoptik · matt Subtle concrete look VilbostonePlus
Erzeugnisgruppe	Feinsteinzeug	Feinsteinzeug	Feinsteinzeug	Feinsteinzeug
Material	Porcelain stoneware	Porcelain stoneware	Porcelain stoneware	Porcelain stoneware
Maßeinheit · Unit of measure	m ² 22,22 kg 5,56 pce	m ² 22,22 kg 5,56 pce	m ² 22,22 kg 5,56 pce	m ² 22,22 kg 5,56 pce
Pro Paket · Per box	1,08 m ² 24 kg 6 pce	1,08 m ² 24 kg 6 pce	1,08 m ² 24 kg 6 pce	1,08 m ² 24 kg 6 pce
Pro Palette · Per pallet	43,20 m ² 960 kg 40 box	43,20 m ² 960 kg 40 box	43,20 m ² 960 kg 40 box	43,20 m ² 960 kg 40 box
Mindestabgabereinheit · Min. sales unit	P (box)	P (box)	P (box)	P (box)
Berechnungseinheit · Calculation unit	m ²	m ²	m ²	m ²
Preisgruppe · Price group	P63	P63	P63	P63
	30 x 60 cm NEW 2023			
Artikelnummer · Article number	2685 CJ62			
Warengruppe · Product group	Grundfliese · Basic tile			
Werksmaße · Dimensions (mm)	297 x 597 x 9 mm			
Farbe · Colour	dark grey			
Oberfläche · Finish	matt Dezente Betonoptik · matt Subtle concrete look VilbostonePlus			
Erzeugnisgruppe	Feinsteinzeug			
Material	Porcelain stoneware			
Maßeinheit · Unit of measure	m ² 22,22 kg 5,56 pce			
Pro Paket · Per box	1,08 m ² 24 kg 6 pce			
Pro Palette · Per pallet	43,20 m ² 960 kg 40 box			
Mindestabgabereinheit · Min. sales unit	P (box)			
Berechnungseinheit · Calculation unit	m ²			
Preisgruppe · Price group	P63			

PRO ARCHITECTURA 3.0

Architektur Design (System) · Architecture Design (System)

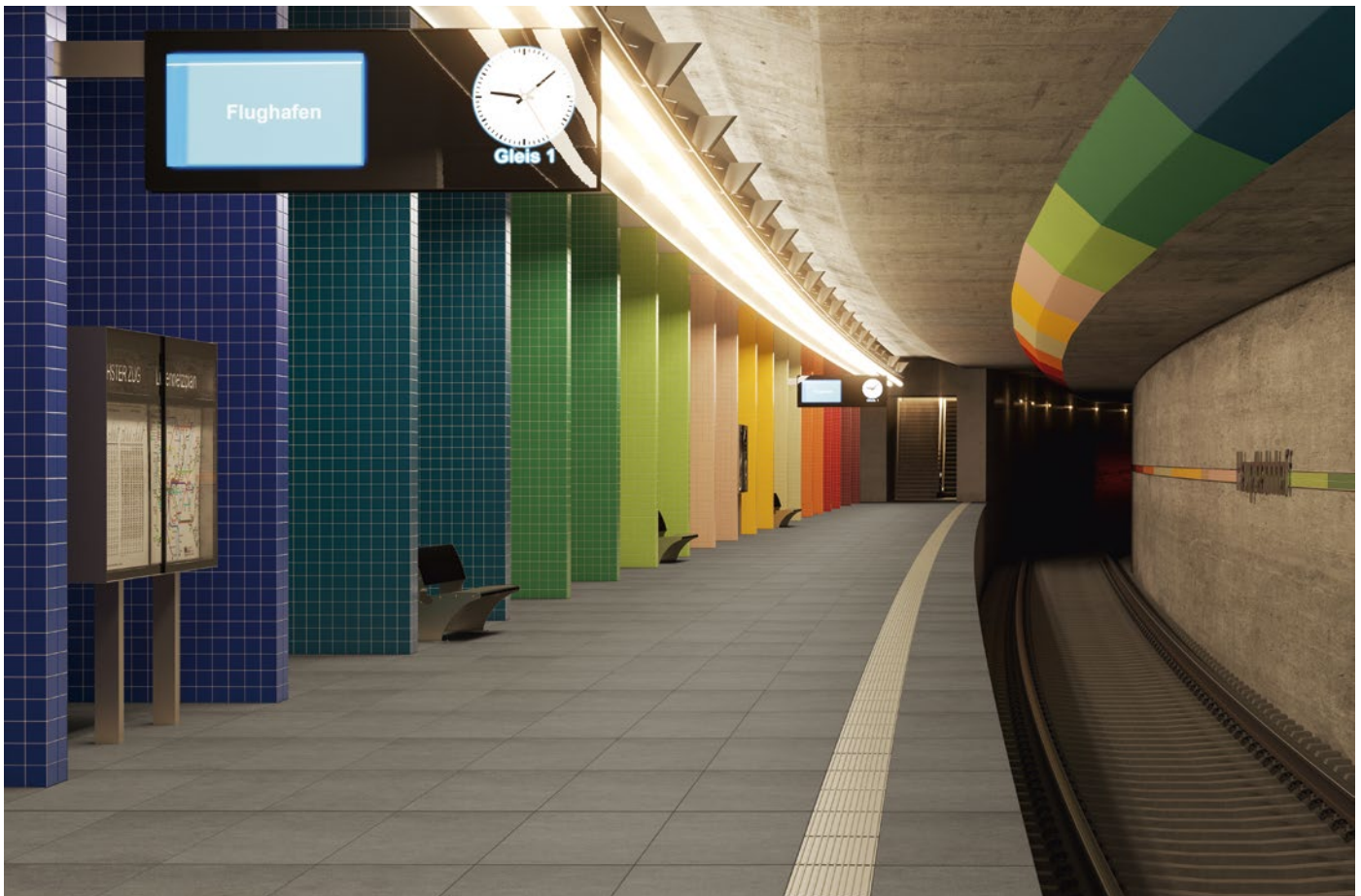
Concept³

www.config-villeroy-boch.com

KONFIGURATOR PRO ARCHITECTURA 3.0

Zur Unterstützung bei der Auswahl und Zusammenstellung der Fliesen nach technischen und gestalterischen Kriterien wurde der PRO ARCHITECTURA 3.0 Konfigurator entwickelt. Die desktop-optimierte Anwendung ermöglicht es, auf sämtliche Farben, Formate, Rutschhemmungen und Materialien von PRO ARCHITECTURA 3.0 zuzugreifen, die Fliesen in einem virtuellen Musterraum anzuordnen und auf einer Merkliste zu speichern.



www.config-villeroy-boch.com

PRO ARCHITECTURA 3.0 CONFIGURATOR

The PRO ARCHITECTURA 3.0 Configurator was developed to assist with the selection and arrangement of tiles on the basis of technical and design criteria. The desktop-optimized application provides access to all the colours, formats, slip-resistance properties and materials of PRO ARCHITECTURA 3.0; it helps arrange the tiles in a virtual model room and save them on a checklist.



PRO ARCHITECTURA 3.0

Farbübersicht · Colours

Violet Touch	Classic Mauve	Red Chili	Toffee Brown	Dark Plum
Soft Rose	Soft Apricot	Glowing Orange	Coral Red	Velvet Red
Biscuit Yellow	Sunshine Yellow	Mango Yellow	Pure Sand	Cocoa Brown
Silk White	Cream White	Pure Clay	Clay Brown	Mystic Brown
Neutral White	Secret Grey	Urban Grey	Solid Grey	Pure Black
Hazy Grey	Flannel Grey	Airy Grey	Silver Grey	Iron Grey
Sky Blue	Icy Blue	Azur Blue	Ocean Blue	Ultramarine Blue
Sage Green	Lagoon Blue	Mint Green	Teal Blue	Sea Blue
Whispering Green	Calming Green	Apple Green	Bottle Green	Forest Green

PRO ARCHITECTURA 3.0

Architektur Design (System) · Architecture Design (System) Concept³

Steinzeug glasiert EN 14411-BIb · Wand und Boden | matt
 Glazed vitreous EN 14411-BIb · Wall and floor | matt

10 × 10 cm

NCS S 1010-R40B C331 Violet Touch 2 RAL 320 85 05	NCS S 2020-R20B C334 Classic Mauve 2 RAL 360 70 15	NCS S 1580-Y90R C330 Red Chili 2 RAL 030 40 60	NCS S 5020-Y80R C381 Toffee Brown 2 RAL 040 50 20	NCS S 8005-R20B C338 Dark Plum 2 RAL 340 20 05
NCS S 1010-R C332 Soft Rose 3 RAL 040 85 05	NCS S 2020-Y60R C333 Soft Apricot 2 RAL 050 70 20	NCS S 1070-Y60R C325 Glowing Orange 2 RAL 050 60 60	NCS S 3040-Y90R C335 Coral Red 2 RAL 030 50 30	NCS S 5040-R C339 Velvet Red 2 RAL 020 30 30
NCS S 1010-Y C321 Biscuit Yellow 3 RAL 095 85 20	NCS S 1060-Y C322 Sunshine Yellow 3 RAL 090 80 60	NCS S 1070-Y10R C320 Mango Yellow 2 RAL 080 70 70	NCS S 2010-Y40R C327 Pure Sand 3 RAL 070 70 20	NCS S 6030-Y70R C380 Cocoa Brown 2 RAL 040 30 30
NCS S 1002-Y C310 Silk White 4 RAL 090 85 05	NCS S 1005-Y10R C311 Cream White 4 RAL 090 85 10	NCS S 3005-Y50R C370 Pure Clay 3 RAL 060 70 05	NCS S 5005-Y50R C371 Clay Brown 2 RAL 040 60 05	NCS S 7005-R20B C372 Mystic Brown 2 RAL 320 40 05
NCS S 0500-N C300 Neutral White 4 RAL 9003	NCS S 2500-N C360 Secret Grey 4 RAL 000 75 00	NCS S 5000-N C361 Urban Grey 2 RAL 000 60 00	NCS S 7500-N C390 Solid Grey 2 RAL 000 35 00	NCS S 9000-N C391 Pure Black 2 RAL 000 15 00
NCS S 1502-R C363 Hazy Grey 3 RAL 300 85 05	NCS S 2005-G50Y C362 Flannel Grey 3 RAL 140 80 05	NCS S 3005-B80G C365 Airy Grey 3 RAL 180 70 05	NCS S 4010-R70B C364 Silver Grey 2 RAL 270 60 10	NCS S 7005-R80B C366 Iron Grey 2 RAL 280 40 10
NCS S 1510-B C341 Sky Blue 3 RAL 240 80 05	NCS S 1030-R80B C344 Icy Blue 2 RAL 260 70 20	NCS S 2040-B C342 Azur Blue 2 RAL 230 60 25	NCS S 4040-R80B C340 Ocean Blue 2 RAL 270 40 30	NCS S 4550-R70B C349 Ultramarine Blue 2 RAL 290 20 35
NCS S 1010-G C353 Sage Green 2 RAL 170 85 10	NCS S 2030-B50G C355 Lagoon Blue 2 RAL 190 70 20	NCS S 1020-B70G C356 Mint Green 3 RAL 170 80 15	NCS S 3030-B30G C354 Teal Blue 2 RAL 200 60 20	NCS S 5045-B10G C345 Sea Blue 2 RAL 220 30 25
NCS S 1020-G60Y C351 Whispering Green 3 RAL 110 85 20	NCS S 3020-G40Y C357 Calming Green 2 RAL 120 60 20	NCS S 2050-G30Y C352 Apple Green 2 RAL 120 70 40	NCS S 4040-G C350 Bottle Green 2 RAL 160 50 30	NCS S 6530-G60Y C358 Forest Green 2 RAL 130 40 20

10 × 10 cm R10B | R10C
 10 × 20 cm R10B | R10C
 10 × 20 cm

NCS S 0500-N C300 Neutral White 4 RAL 9003	NCS S 7500-N C390 Solid Grey 2 RAL 000 35 00
NCS S 1030-R80B C344 Icy Blue 2 RAL 260 70 20	NCS S 4550-R70B C349 Ultramarine Blue 2 RAL 290 20 35

PRO ARCHITECTURA 3.0

Steinzeug glasiert EN 14411-BIb · Wand und Boden | matt
Glazed vitreous EN 14411-BIb · Wall and floor | matt

- 2,5 × 2,5 cm R9
- 5 × 5 cm R9
- 10 × 30 cm
- 20 × 20 cm

NCS S 3040-Y90R
C335
Coral Red
2
RAL 030 50 30

NCS S 1070-Y10R
C320
Mango Yellow
2
RAL 080 70 70

NCS S 1002-Y
C310
Silk White
4
RAL 090 85 05

NCS S 1005-Y10R
C311
Cream White
4
RAL 090 85 10

NCS S 3005-Y50R
C370
Pure Clay
3
RAL 060 70 05

NCS S 5005-Y50R
C371
Clay Brown
2
RAL 040 60 05

NCS S 7005-R20B
C372
Mystic Brown
2
RAL 320 40 05

NCS S 0500-N
C300
Neutral White
4
RAL 9003

NCS S 2500-N
C360
Secret Grey
4
RAL 000 75 00

NCS S 5000-N
C361
Urban Grey
2
RAL 000 60 00

NCS S 7500-N
C390
Solid Grey
2
RAL 000 35 00

NCS S 9000-N
C391
Pure Black
2
RAL 000 15 00

NCS S 4550-R70B
C349
Ultramarine Blue
2
RAL 290 20 35

NCS S 2030-B50G
C355
Lagoon Blue
2
RAL 190 70 20

NCS S 2050-G30Y
C352
Apple Green
2
RAL 120 70 40

PRO ARCHITECTURA 3.0 Architektur Design (System) · Architecture Design (System)

Concept³

Steingut EN 14411-BIII · Wand | glänzend
Nonvitreous EN 14411-BIII · Wall | glossy

CeramicPlus

20 × 20 cm

	<p>NCS S 2020-R20B C134 Classic Mauve RAL 360 70 15</p>	<p>NCS S 1580-Y90R C130 Red Chili RAL 030 40 60</p>		<p>NCS S 8005-R20B C138 Dark Plum RAL 340 20 05</p>
<p>NCS S 1010-R C132 Soft Rose RAL 040 85 05</p>		<p>NCS S 1070-Y60R C125 Glowing Orange RAL 050 60 60</p>		<p>NCS S 5040-R C139 Velvet Red RAL 020 30 30</p>
	<p>NCS S 1060-Y C122 Sunshine Yellow RAL 090 80 60</p>		<p>NCS S 2010-Y40R C127 Pure Sand RAL 070 70 20</p>	
<p>NCS S 1002-Y C110 Silk White RAL 090 85 05</p>	<p>NCS S 1005-Y10R C111 Cream White RAL 090 85 10</p>	<p>NCS S 3005-Y50R C170 Pure Clay RAL 060 70 05</p>	<p>NCS S 5005-Y50R C171 Clay Brown RAL 040 60 05</p>	<p>NCS S 7005-R20B C172 Mystic Brown RAL 320 40 05</p>
<p>NCS S 0500-N C100 Neutral White RAL 9003</p>	<p>NCS S 2500-N C160 Secret Grey RAL 000 75 00</p>	<p>NCS S 5000-N C161 Urban Grey RAL 000 60 00</p>	<p>NCS S 7500-N C190 Solid Grey RAL 000 35 00</p>	<p>NCS S 9000-N C191 Pure Black RAL 000 15 00</p>
<p>NCS S 1510-B C141 Sky Blue RAL 240 80 05</p>				<p>NCS S 4550-R70B C149 Ultramarine Blue RAL 290 20 35</p>
<p>NCS S 1010-G C153 Sage Green RAL 170 85 10</p>		<p>NCS S 3030-B30G C154 Teal Blue RAL 200 60 20</p>		<p>NCS S 5045-B10G C145 Sea Blue RAL 220 30 25</p>
	<p>NCS S 2050-G30Y C152 Apple Green RAL 120 70 40</p>	<p>NCS S 4040-G C150 Bottle Green RAL 160 50 30</p>		

15 × 15 cm
20 × 60 cm
30 × 60 cm

15 × 15 cm
20 × 60 cm

<p>NCS S 1002-Y C110 Silk White RAL 090 85 05</p>	<p>NCS S 1005-Y10R C111 Cream White RAL 090 85 10</p>	<p>NCS S 5005-Y50R C171 Clay Brown RAL 040 60 05</p>				
<p>NCS S 0500-N C100 Neutral White RAL 9003</p>	<p>NCS S 2500-N C160 Secret Grey RAL 000 75 00</p>	<p>NCS S 7500-N C190 Solid Grey RAL 000 35 00</p>				

PRO ARCHITECTURA 3.0

Steingut EN 14411-BIII · Wand | matt
 Nonvitreous EN 14411-BIII · Wall | matt

CeramicPlus
 PowderTouch

20 × 20 cm

NCS S 2020-R20B
C034
 Classic Mauve
 RAL 360 70 15

NCS S 1010-R
C032
 Soft Rose
 RAL 040 85 05

NCS S 1002-Y
C010
 Silk White
 RAL 090 85 05

NCS S 1005-Y10R
C011
 Cream White
 RAL 090 85 10

NCS S 3005-Y50R
C070
 Pure Clay
 RAL 060 70 05

NCS S 5005-Y50R
C071
 Clay Brown
 RAL 040 60 05

NCS S 7005-R20B
C072
 Mystic Brown
 RAL 320 40 05

NCS S 0500-N
C000
 Neutral White
 RAL 9003

NCS S 2500-N
C060
 Secret Grey
 RAL 000 75 00

NCS S 5000-N
C061
 Urban Grey
 RAL 000 60 00

NCS S 7500-N
C090
 Solid Grey
 RAL 000 35 00

NCS S 9000-N
C091
 Pure Black
 RAL 000 15 00

NCS S 1510-B
C041
 Sky Blue
 RAL 240 80 05

NCS S 1010-G
C053
 Sage Green
 RAL 170 85 10

15 × 15 cm
 20 × 60 cm
 30 × 60 cm

15 × 15 cm
 20 × 60 cm

NCS S 1002-Y
C010
 Silk White
 RAL 090 85 05

NCS S 1005-Y10R
C011
 Cream White
 RAL 090 85 10

NCS S 5005-Y50R
C071
 Clay Brown
 RAL 040 60 05

NCS S 0500-N
C000
 Neutral White
 RAL 9003

NCS S 2500-N
C060
 Secret Grey
 RAL 000 75 00

NCS S 7500-N
C090
 Solid Grey
 RAL 000 35 00

PRO ARCHITECTURA 3.0

VilboStone Feinsteinzeug EN 14411-Bla · Boden | uni | matt
VilboStone porcelain stoneware, EN 14411-Bla · Floor | uni | matt

VilboStone
VilbostonePlus

15 × 15 cm R10B
 30 × 30 cm R10A

2,5 × 2,5 cm R10C
 10 × 10 cm R11C
 20 × 20 cm R11C

NCS S 1005-Y10R
C211
 Cream White
 RAL 090 85 10

NCS S 3005-Y50R
C270
 Pure Clay
 RAL 060 70 05

NCS S 5005-Y50R
C271
 Clay Brown
 RAL 040 60 05

NCS S 1005-Y10R
C211
 Cream White
 RAL 090 85 10

NCS S 2500-N
C260
 Secret Grey
 RAL 000 75 00

NCS S 7500-N
C290
 Solid Grey
 RAL 000 35 00

NCS S 9000-N
C291
 Pure Black
 RAL 000 15 00

NCS S 7500-N
C290
 Solid Grey
 RAL 000 35 00

NCS S 1030-R80B
C244
 Icy Blue
 RAL 260 70 20

NCS S 4040-R80B
C240
 Ocean Blue
 RAL 270 40 30

PRO ARCHITECTURA 3.0 Architektur Design (System) · Architecture Design (System)

Concept³

VilboStone Feinsteinzeug EN 14411-Bla · Boden | Granitstruktur | matt
VilboStone porcelain stoneware, EN 14411-Bla · Floor | Granite structure | matt

VilboStone
VilbostonePlus

10 × 10 cm R10B

5 × 5 cm R10B
 15 × 15 cm R10B | R11B | R12 | R12-V4
 20 × 20 cm R10B | R11B | R12 | R12-V4/B
 30 × 30 cm R9 | R10A | R11B
 30 × 60 cm R10A
 60 × 60 cm R9

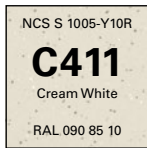



reddot winner 2021

Concept³

PRO ARCHITECTURA 3.0

Steingut EN 14411-BIII · Nonvitreous EN 14411-BIII

	15 x 15 cm	15 x 15 cm	20 x 20 cm	20 x 20 cm
Artikelnummer · Article number	1106	1106	1190	1190
	C000, C010, C060	C011, C071, C090	C000, C010, C011 C060, C061, C070 C071, C072, C090, C091	C032, C034, C041 C053
Warengruppe · Product group	Grundfliese · Basic tile	Grundfliese · Basic tile	Grundfliese · Basic tile	Grundfliese · Basic tile
Werkmaße · Dimensions (mm)	147 x 147 x 6 mm	147 x 147 x 6 mm	197 x 197 x 6 mm	197 x 197 x 6 mm
Farbe · Colour	-	-	-	-
Oberfläche · Finish	Unifarbene Mattglasur · Plain-coloured glaze	Unifarbene Mattglasur · Plain-coloured glaze	Unifarbene Mattglasur · Plain-coloured glaze	Unifarbene Mattglasur · Plain-coloured glaze
	PowderTouch CeramicPlus	PowderTouch CeramicPlus	PowderTouch CeramicPlus	PowderTouch CeramicPlus
Erzeugnisgruppe	Steingut	Steingut	Steingut	Steingut
Material	Nonvitreous	Nonvitreous	Nonvitreous	Nonvitreous
Maßeinheit · Unit of measure	m ² 10,12 kg 44 pce	m ² 10,12 kg 44 pce	m ² 10,75 kg 25 pce	m ² 10,75 kg 25 pce
Pro Paket · Per box	1 m ² 10,12 kg 44 pce	1 m ² 10,12 kg 44 pce	1,20 m ² 12,90 kg 30 pce	1,20 m ² 12,90 kg 30 pce
Pro Palette · Per pallet	100 m ² 1012 kg 100 box	100 m ² 1012 kg 100 box	96 m ² 1032 kg 80 box	96 m ² 1032 kg 80 box
Mindestabgabeneinheit · Min. sales unit	P (box)	P (box)	P (box)	P (box)
Berechnungseinheit · Calculation unit	m ²	m ²	m ²	m ²
Preisgruppe · Price group	P72	P72	P77	P83

Die matten Fliesen sind reflexionsfrei und daher für Operationsräume geeignet.
The matt tiles are non-reflecting and suitable for use in operating theatres.

	20 x 60 cm	20 x 60 cm	30 x 60 cm
Artikelnummer · Article number	1260	1260	1555
	C000, C010, C011 C060	C071, C090	C000, C010, C011 C060
Warengruppe · Product group	Grundfliese · Basic tile	Grundfliese · Basic tile	Grundfliese · Basic tile
Werkmaße · Dimensions (mm)	197 x 597 x 9 mm	197 x 597 x 9 mm	297 x 597 x 9 mm
Farbe · Colour	-	-	-
Oberfläche · Finish	Unifarbene Mattglasur · Plain-coloured glaze	Unifarbene Mattglasur · Plain-coloured glaze	Unifarbene Mattglasur · Plain-coloured glaze
	PowderTouch CeramicPlus	PowderTouch CeramicPlus	PowderTouch CeramicPlus
Erzeugnisgruppe	Steingut	Steingut	Steingut
Material	Nonvitreous	Nonvitreous	Nonvitreous
Maßeinheit · Unit of measure	m ² 15,42 kg 8,33 pce	m ² 15,42 kg 8,33 pce	m ² 15,56 kg 5,56 pce
Pro Paket · Per box	1,08 m ² 16,65 kg 9 pce	1,08 m ² 16,65 kg 9 pce	1,08 m ² 16,80 kg 6 pce
Pro Palette · Per pallet	69,12 m ² 1065,60 kg 64 box	69,12 m ² 1065,60 kg 64 box	51,84 m ² 806,40 kg 48 box
Mindestabgabeneinheit · Min. sales unit	P (box)	P (box)	P (box)
Berechnungseinheit · Calculation unit	m ²	m ²	m ²
Preisgruppe · Price group	P109	P109	P110

Die matten Fliesen sind reflexionsfrei und daher für Operationsräume geeignet.
The matt tiles are non-reflecting and suitable for use in operating theatres.

PRO ARCHITECTURA 3.0

Architektur Design (System) · Architecture Design (System)

Concept³

Steingut EN 14411-BIII · Nonvitreous EN 14411-BIII

	15 x 15 cm	15 x 15 cm	20 x 20 cm	20 x 20 cm
Artikelnummer · Article number	1106	1106	1190	1190
	C100, C110, C160	C111, C171, C190	C100, C110, C111 C160, C161, C170 C171, C172, C190, C191	C122, C125, C127 C130, C132, C134 C138, C139, C141 C145, C149, C150 C152, C153, C154
Warengruppe · Product group	Grundfliese · Basic tile	Grundfliese · Basic tile	Grundfliese · Basic tile	Grundfliese · Basic tile
Werksmaße · Dimensions (mm)	147 x 147 x 6 mm	147 x 147 x 6 mm	197 x 197 x 6 mm	197 x 197 x 6 mm
Farbe · Colour	-	-	-	-
Oberfläche · Finish	glänzend Unifarbene Glasur · glossy Plain-coloured glaze CeramicPlus	glänzend Unifarbene Glasur · glossy Plain-coloured glaze CeramicPlus	glänzend Unifarbene Glasur · glossy Plain-coloured glaze CeramicPlus	glänzend Unifarbene Glasur · glossy Plain-coloured glaze CeramicPlus
Erzeugnisgruppe	Steingut	Steingut	Steingut	Steingut
Material	Nonvitreous	Nonvitreous	Nonvitreous	Nonvitreous
Maßeinheit · Unit of measure	m ² 10,12 kg 44 pce	m ² 10,12 kg 44 pce	m ² 10,75 kg 25 pce	m ² 10,75 kg 25 pce
Pro Paket · Per box	1 m ² 10,12 kg 44 pce	1 m ² 10,12 kg 44 pce	1,20 m ² 12,90 kg 30 pce	1,20 m ² 12,90 kg 30 pce
Pro Palette · Per pallet	100 m ² 1012 kg 100 box	100 m ² 1012 kg 100 box	96 m ² 1032 kg 80 box	96 m ² 1032 kg 80 box
Mindestabgabereinheit · Min. sales unit	P (box)	P (box)	P (box)	P (box)
Berechnungseinheit · Calculation unit	m ²	m ²	m ²	m ²
Preisgruppe · Price group	P72	P72	P77	P83
	20 x 60 cm	20 x 60 cm	30 x 60 cm	
Artikelnummer · Article number	1260	1260	1555	
	C100, C110, C111 C160	C171, C190	C100, C110, C111 C160	
Warengruppe · Product group	Grundfliese · Basic tile	Grundfliese · Basic tile	Grundfliese · Basic tile	
Werksmaße · Dimensions (mm)	197 x 597 x 9 mm	197 x 597 x 9 mm	297 x 597 x 9 mm	
Farbe · Colour	-	-	-	
Oberfläche · Finish	glänzend Unifarbene Glasur · glossy Plain-coloured glaze CeramicPlus	glänzend Unifarbene Glasur · glossy Plain-coloured glaze CeramicPlus	glänzend Unifarbene Glasur · glossy Plain-coloured glaze CeramicPlus	
Erzeugnisgruppe	Steingut	Steingut	Steingut	
Material	Nonvitreous	Nonvitreous	Nonvitreous	
Maßeinheit · Unit of measure	m ² 15,42 kg 8,33 pce	m ² 15,42 kg 8,33 pce	m ² 15,56 kg 5,56 pce	
Pro Paket · Per box	1,08 m ² 16,65 kg 9 pce	1,08 m ² 16,65 kg 9 pce	1,08 m ² 16,80 kg 6 pce	
Pro Palette · Per pallet	69,12 m ² 1065,60 kg 64 box	69,12 m ² 1065,60 kg 64 box	51,84 m ² 806,40 kg 48 box	
Mindestabgabereinheit · Min. sales unit	P (box)	P (box)	P (box)	
Berechnungseinheit · Calculation unit	m ²	m ²	m ²	
Preisgruppe · Price group	P109	P109	P110	

Mengenabhängiger Preiszuschlag bei zweifarbiger Schachbrettklebung von Mosaikfliesen (zzgl. Mischpreis der eingesetzten Mosaikfliesen)
Quantity-related surcharge for two-colour chequered arrangements of mosaic tiles (in addition to mixed price of the mosaic tiles used)

Auftragsmenge / Order quantity	Format 2,5 x 2,5 cm	Format 5 x 5 cm	Format 10 x 10 cm
bis 2 m ²	P184	P160	P148
2 - bis 5 m ²	P172	P148	P124
5 - 10 m ²	P170	P139	P120
ab 10 m ²	P165	P134	P110

Mengenabhängiger Preiszuschlag von wahllosen Mischungen von Mosaikfliesen (zzgl. Mischpreis der eingesetzten Mosaikfliesen)
Quantity-related surcharge for random mixes of mosaic tiles (in addition to mixed price of the mosaic tiles used)

Auftragsmenge / Order quantity	Format 2,5 x 2,5 cm	Format 5 x 5 cm	Format 10 x 10 cm
bis 2 m ²	P195	P165	P158
2 - bis 5 m ²	P181	P158	P134
5 - 10 m ²	P177	P152	P130
ab 10 m ²	P172	P148	P124

PRO ARCHITECTURA 3.0

Steinzeug glasiert EN 14411-BIb · Glazed vitreous, EN 14411-BIb

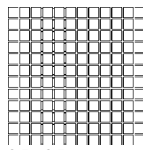

2,5 x 2,5 cm

0,09 m² | 297 x 297 mm

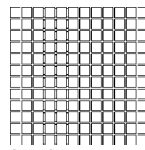

2,5 x 2,5 cm

0,09 m² | 297 x 297 mm

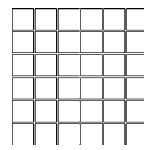

5 x 5 cm

0,09 m² | 297 x 297 mm

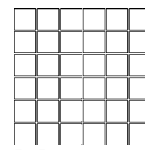

5 x 5 cm

0,09 m² | 297 x 297 mm

Artikelnummer · Article number

3753

C300, C310, C311, C360
C370
C361, C371, C372
C390, C391

4 ✱ R9
3 ✱ R9
2 ✱ R9
2 ✱ R9

Warengruppe · Product group

Grundfliese · Basic tile

Werkmaße · Dimensions (mm)

23 x 23 x 6 mm

Farbe · Colour

-

Oberfläche · Finish

matt

Erzeugnisgruppe

Steinzeug glasiert

Material

Glazed vitreous

Maßeinheit · Unit of measure

m² | 11,55 kg | 11 pce

Pro Paket · Per box

1 m² | 11,55 kg | 11 pce

Pro Palette · Per pallet

78 m² | 900,90 kg | 78 box

Mindestabgabereinheit · Min. sales unit

P (box)

Berechnungseinheit · Calculation unit

m²

Preisgruppe · Price group

P138

Für Schachbrettklebung oder wahllose Mischungen kalkulieren Sie auf den Mischpreis der einzusetzenden Artikel mit den format- und mengenbezogenen Preisen, die Sie der Tabelle auf Seite 170 entnehmen können. Achtung: Hierauf werden keine Palettenkonditionen gewährt. Für in Sonderfällen gewünschte Lieferform von losen Fliesen wird ein Aufschlag von 10% berechnet. For chequered arrangements or random mixes, calculate by adding the format- and quantity-related prices found in the table on page 170 to the mixed price for the items to be used. N.B: No pallet terms are granted for these special tiling arrangements. For delivery of single tiles in special cases there will be an additional charge of 10%.

Die matten Fliesen sind reflexionsfrei und daher für Operationsräume geeignet. The matt tiles are non-reflecting and suitable for use in operating theatres.

3753

C320, C335, C349
C352, C355

2 ✱ R9
2 ✱ R9

Grundfliese · Basic tile

23 x 23 x 6 mm

-

matt

Steinzeug glasiert

Glazed vitreous

m² | 11,55 kg | 11 pce

1 m² | 11,55 kg | 11 pce

78 m² | 900,90 kg | 78 box

P (box)

m²

P150

3709

C300, C310, C311, C360
C370
C361, C371, C372
C390, C391

4 ✱ R9
3 ✱ R9
2 ✱ R9
2 ✱ R9

Grundfliese · Basic tile

48 x 48 x 6 mm

-

matt

Steinzeug glasiert

Glazed vitreous

m² | 11,77 kg | 11 pce

1 m² | 11,77 kg | 11 pce

78 m² | 918,06 kg | 78 box

P (box)

m²

P109

Für Schachbrettklebung oder wahllose Mischungen kalkulieren Sie auf den Mischpreis der einzusetzenden Artikel mit den format- und mengenbezogenen Preisen, die Sie der Tabelle auf Seite 170 entnehmen können. Achtung: Hierauf werden keine Palettenkonditionen gewährt. Für in Sonderfällen gewünschte Lieferform von losen Fliesen wird ein Aufschlag von 10% berechnet. For chequered arrangements or random mixes, calculate by adding the format- and quantity-related prices found in the table on page 170 to the mixed price for the items to be used. N.B: No pallet terms are granted for these special tiling arrangements. For delivery of single tiles in special cases there will be an additional charge of 10%.

Die matten Fliesen sind reflexionsfrei und daher für Operationsräume geeignet. The matt tiles are non-reflecting and suitable for use in operating theatres.

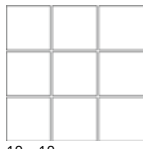

10 x 10 cm

0,09 m² | 297 x 297 mm

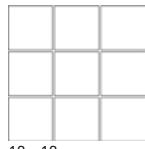

10 x 10 cm

0,09 m² | 297 x 297 mm

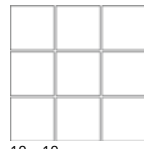

10 x 10 cm

0,09 m² | 297 x 297 mm

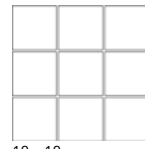

10 x 10 cm

0,09 m² | 297 x 297 mm

Artikelnummer · Article number

3201

C300, C310, C311, C360
C362, C363, C365, C370
C361, C364, C366
C371, C372, C390, C391

4 ✱ R10
3 ✱ R10
2 ✱ R10
2 ✱ R10

Warengruppe · Product group

Grundfliese · Basic tile

Werkmaße · Dimensions (mm)

97 x 97 x 6 mm

Farbe · Colour

-

Oberfläche · Finish

matt | Unifarbene Glasur · matt | Plain-coloured glaze

Erzeugnisgruppe

Steinzeug glasiert

Material

Glazed vitreous

Maßeinheit · Unit of measure

m² | 12,10 kg | 11 pce

Pro Paket · Per box

1 m² | 12,10 kg | 11 pce

Pro Palette · Per pallet

78 m² | 943,80 kg | 78 box

Mindestabgabereinheit · Min. sales unit

P (box)

Berechnungseinheit · Calculation unit

m²

Preisgruppe · Price group

P109

3201

C321, C322, C327, C332
C320, C325, C330, C331
C333, C334, C335, C338
C339, C380, C381

3 ✱ R10
2 ✱ R10
2 ✱ R10
2 ✱ R10

Grundfliese · Basic tile

97 x 97 x 6 mm

-

matt | Unifarbene Glasur · matt | Plain-coloured glaze

Steinzeug glasiert

Glazed vitreous

m² | 12,10 kg | 11 pce

1 m² | 12,10 kg | 11 pce

78 m² | 943,80 kg | 78 box

P (box)

m²

P122

3201

C341, C351, C356
C340, C342, C344, C345
C349, C350, C352, C353
C354, C355, C357, C358

3 ✱ R10
2 ✱ R10
2 ✱ R10
2 ✱ R10

Grundfliese · Basic tile

97 x 97 x 6 mm

-

matt | Unifarbene Glasur · matt | Plain-coloured glaze

Steinzeug glasiert

Glazed vitreous

m² | 12,10 kg | 11 pce

1 m² | 12,10 kg | 11 pce

78 m² | 943,80 kg | 78 box

P (box)

m²

P122

3245

C300
C390

4 ✱ R10
2 ✱ R10

Grundfliese · Basic tile

97 x 97 x 6 mm

-

matt | Unifarbene Glasur · matt | Plain-coloured glaze

Steinzeug glasiert

Glazed vitreous

m² | 12,10 kg | 11 pce

1 m² | 12,10 kg | 11 pce

78 m² | 943,80 kg | 78 box

P (box)

m²

P102

Für Schachbrettklebung oder wahllose Mischungen kalkulieren Sie auf den Mischpreis der einzusetzenden Artikel mit den format- und mengenbezogenen Preisen, die Sie der Tabelle auf Seite 170 entnehmen können. Achtung: Hierauf werden keine Palettenkonditionen gewährt. Für in Sonderfällen gewünschte Lieferform von losen Fliesen wird ein Aufschlag von 10% berechnet. Die matten Fliesen sind reflexionsfrei und daher für Operationsräume geeignet. For chequered arrangements or random mixes, calculate by adding the format- and quantity-related prices found in the table on page 170 to the mixed price for the items to be used. N.B: No pallet terms are granted for these special tiling arrangements. For delivery of single tiles in special cases there will be an additional charge of 10%. The matt tiles are non-reflecting and suitable for use in operating theatres.

Die matten Fliesen sind reflexionsfrei und daher für Operationsräume geeignet. The matt tiles are non-reflecting and suitable for use in operating theatres.

PRO ARCHITECTURA 3.0

Architektur Design (System) · Architecture Design (System)

Concept³

Steinzeug glasiert EN 14411-BIb · Glazed vitreous, EN 14411-BIb

	10 x 10 cm □ 0,09 m ² 297 x 297 mm	10 x 10 cm □ 0,09 m ² 297 x 297 mm	10 x 10 cm □ 0,09 m ² 297 x 297 mm	10 x 20 cm
Artikelnummer · Article number	3245	3246	3246	3213
	C344, C349	C300 C390	C344, C349	C300 C390
Warengruppe · Product group	Grundfliese · Basic tile	Grundfliese · Basic tile	Grundfliese · Basic tile	Grundfliese · Basic tile
Werkmaße · Dimensions (mm)	97 x 97 x 6 mm	97 x 97 x 6 mm	97 x 97 x 6 mm	97 x 197 x 6 mm
Farbe · Colour	-	-	-	-
Oberfläche · Finish	matt	matt Unifarbene Glasur · matt Plain-coloured glaze	matt	matt
Erzeugnisgruppe	Steinzeug glasiert	Steinzeug glasiert	Steinzeug glasiert	Steinzeug glasiert
Material	Glazed vitreous	Glazed vitreous	Glazed vitreous	Glazed vitreous
Maßeinheit · Unit of measure	m ² 12,10 kg 11 pce	m ² 12,10 kg 11 pce	m ² 12,10 kg 11 pce	m ² 12,50 kg 50 pce
Pro Paket · Per box	1 m ² 12,10 kg 11 pce	1 m ² 12,10 kg 11 pce	1 m ² 12,10 kg 11 pce	1 m ² 12,50 kg 50 pce
Pro Palette · Per pallet	78 m ² 943,80 kg 78 box	78 m ² 943,80 kg 78 box	78 m ² 943,80 kg 78 box	72 m ² 900 kg 72 box
Mindestabgabeneinheit · Min. sales unit	P (box)	P (box)	P (box)	P (box)
Berechnungseinheit · Calculation unit	m ²	m ²	m ²	m ²
Preisgruppe · Price group	P114	P102	P114	P104
Artikelnummer · Article number	3213	3214	3214	3215
	C344, C349	C300 C390	C344, C349	C300 C390
Warengruppe · Product group	Grundfliese · Basic tile	Grundfliese · Basic tile	Grundfliese · Basic tile	Grundfliese · Basic tile
Werkmaße · Dimensions (mm)	97 x 197 x 6 mm	97 x 197 x 6 mm	97 x 197 x 6 mm	97 x 197 x 6 mm
Farbe · Colour	-	-	-	-
Oberfläche · Finish	matt	matt	matt	matt
Erzeugnisgruppe	Steinzeug glasiert	Steinzeug glasiert	Steinzeug glasiert	Steinzeug glasiert
Material	Glazed vitreous	Glazed vitreous	Glazed vitreous	Glazed vitreous
Maßeinheit · Unit of measure	m ² 12,50 kg 50 pce	m ² 12,50 kg 50 pce	m ² 12,50 kg 50 pce	m ² 12,50 kg 50 pce
Pro Paket · Per box	1 m ² 12,50 kg 50 pce	1 m ² 12,50 kg 50 pce	1 m ² 12,50 kg 50 pce	1 m ² 12,50 kg 50 pce
Pro Palette · Per pallet	72 m ² 900 kg 72 box	72 m ² 900 kg 72 box	72 m ² 900 kg 72 box	72 m ² 900 kg 72 box
Mindestabgabeneinheit · Min. sales unit	P (box)	P (box)	P (box)	P (box)
Berechnungseinheit · Calculation unit	m ²	m ²	m ²	m ²
Preisgruppe · Price group	P113	P104	P113	P104
Artikelnummer · Article number	3215	3350	3350	3107
	C344, C349	C300, C310, C311, C360 C370 C361, C371, C372 C390, C391	C320, C335, C349 C352, C355	C300, C310, C311, C360 C370 C361, C371, C372 C390, C391
Warengruppe · Product group	Grundfliese · Basic tile	Grundfliese · Basic tile	Grundfliese · Basic tile	Grundfliese · Basic tile
Werkmaße · Dimensions (mm)	97 x 197 x 6 mm	97 x 297 x 6 mm	97 x 297 x 6 mm	197 x 197 x 6 mm
Farbe · Colour	-	-	-	-
Oberfläche · Finish	matt	matt	matt	matt
Erzeugnisgruppe	Steinzeug glasiert	Steinzeug glasiert	Steinzeug glasiert	Steinzeug glasiert
Material	Glazed vitreous	Glazed vitreous	Glazed vitreous	Glazed vitreous
Maßeinheit · Unit of measure	m ² 12,50 kg 50 pce	m ² 12,21 kg 33 pce	m ² 12,21 kg 33 pce	m ² 13,25 kg 25 pce
Pro Paket · Per box	1 m ² 12,50 kg 50 pce	1 m ² 12,21 kg 33 pce	1 m ² 12,21 kg 33 pce	1 m ² 13,25 kg 25 pce
Pro Palette · Per pallet	72 m ² 900 kg 72 box	72 m ² 879,12 kg 72 box	72 m ² 879,12 kg 72 box	81 m ² 1073,25 kg 81 box
Mindestabgabeneinheit · Min. sales unit	P (box)	P (box)	P (box)	P (box)
Berechnungseinheit · Calculation unit	m ²	m ²	m ²	m ²
Preisgruppe · Price group	P113	P98	P112	P101

Die matten Fliesen sind reflexionsfrei und daher für Operationsräume geeignet.
The matt tiles are non-reflecting and suitable for use in operating theatres.

Die matten Fliesen sind reflexionsfrei und daher für Operationsräume geeignet.
The matt tiles are non-reflecting and suitable for use in operating theatres.











reddot winner 2021

Concept³

PRO ARCHITECTURA 3.0

Steinzeug glasiert EN 14411-B1b · Glazed vitreous, EN 14411-B1b

				
Artikelnummer · Article number	3107	3293	3296	3295
	C320, C335, C349 C352, C355	C300, C360	C300, C360	C300, C360
Warengruppe · Product group	Grundfliese · Basic tile	Hohlkehlsoclel · Cove base	Innenecke · Inside corner	Aussenecke · Outside corner
Werksmaße · Dimensions (mm)	197 x 197 x 6 mm	97 x 106 x 6 mm	21 x 106 x 6 mm	36 x 106 x 6 mm
Farbe · Colour	-	-	-	-
Oberfläche · Finish	matt	matt	matt	matt
Erzeugnisgruppe	Steinzeug glasiert	Steinzeug glasiert	Steinzeug glasiert	Steinzeug glasiert
Material	Glazed vitreous	Glazed vitreous	Glazed vitreous	Glazed vitreous
Maßeinheit · Unit of measure	m ² 13,25 kg 25 pce	m 1,40 kg 10 pce	pce 0,05 kg 1 pce	pce 0,06 kg 1 pce
Pro Paket · Per box	1 m ² 13,25 kg 25 pce	5 m 7 kg 50 pce	20 pce 1 kg 20 pce	24 pce 1,44 kg 24 pce
Pro Palette · Per pallet	81 m ² 1073,25 kg 81 box	525 m 735 kg 105 box	-	-
Mindestabgabereinheit · Min. sales unit	P (box)	E (pce)	E (pce)	E (pce)
Berechnungseinheit · Calculation unit	m ²	Stück · piece	Stück · piece	Stück · piece
Preisgruppe · Price group	P112	E20	E51	E51
<p>Die matten Fliesen sind reflexionsfrei und daher für Operationsräume geeignet. The matt tiles are non-reflecting and suitable for use in operating theatres.</p>		<p>Wegen der unterschiedlichen Produktionsverfahren von Fliesen und Formstücken können leichte Farbabweichungen auftreten. Due to different production methods used in manufacturing tiles and mouldings there is the possibility that slight colour variations may occur.</p>		
				
Artikelnummer · Article number	3294	3297	3007	3009
	C300, C360	C300, C360	C300, C360	C300, C360
Warengruppe · Product group	Innenecke-Läufer · Inside corner, running piece	Aussenecke-Läufer · Outside corner, running piece	Läufer · Running piece	Ecke · Corner
Werksmaße · Dimensions (mm)	21 x 97 x 6 mm	21 x 97 x 6 mm	97 x 97 x 6 mm	97 x 97 x 6 mm
Farbe · Colour	-	-	-	-
Oberfläche · Finish	matt	matt	matt	matt
Erzeugnisgruppe	Steinzeug glasiert	Steinzeug glasiert	Steinzeug glasiert	Steinzeug glasiert
Material	Glazed vitreous	Glazed vitreous	Glazed vitreous	Glazed vitreous
Maßeinheit · Unit of measure	pce 0,03 kg 1 pce	pce 0,04 kg 1 pce	m 1,80 kg 10 pce	pce 0,26 kg 1 pce
Pro Paket · Per box	45 pce 1,35 kg 45 pce	45 pce 1,80 kg 45 pce	4,20 m 7,56 kg 42 pce	30 pce 7,80 kg 30 pce
Pro Palette · Per pallet	-	-	441 m 793,80 kg 105 box	3150 pce 819 kg 105 box
Mindestabgabereinheit · Min. sales unit	E (pce)	E (pce)	E (pce)	E (pce)
Berechnungseinheit · Calculation unit	Stück · piece	Stück · piece	Stück · piece	Stück · piece
Preisgruppe · Price group	E51	E51	E29	E64
<p>Wegen der unterschiedlichen Produktionsverfahren von Fliesen und Formstücken können leichte Farbabweichungen auftreten. Due to different production methods used in manufacturing tiles and mouldings there is the possibility that slight colour variations may occur.</p>				

PRO ARCHITECTURA 3.0

Architektur Design (System) · Architecture Design (System)

Concept³

Steinzeug glasiert EN 14411-B1b · Glazed vitreous, EN 14411-B1b

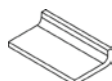

5 x 10 cm



5 x 5 cm

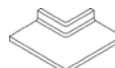

10 x 10 cm

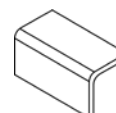

5 x 10 cm

Artikelnummer · Article number	3570	3571	3572	3573
Warengruppe · Product group	C300, C360	C300, C360	C300, C360	C300, C360
Werkgröße · Dimensions (mm)	Hohlkehlsockel · Cove base 56 x 97 x 6 mm	Innenecke · Inside corner 47 x 47 x 6 mm	Aussenecke · Outside corner 97 x 97 x 6 mm	Aussenecke · Outside corner 47 x 97 x 6 mm
Farbe · Colour	-	-	-	-
Oberfläche · Finish	matt	matt	matt	matt
Erzeugnisgruppe	Steinzeug glasiert	Steinzeug glasiert	Steinzeug glasiert	Steinzeug glasiert
Material	Glazed vitreous	Glazed vitreous	Glazed vitreous	Glazed vitreous
Maßeinheit · Unit of measure	m 1,20 kg 10 pce	pce 0,07 kg 1 pce	pce 0,13 kg 1 pce	pce 0,20 kg 1 pce
Pro Paket · Per box	4,80 m 5,76 kg 48 pce	6 pce 0,42 kg 6 pce	8 pce 1,04 kg 8 pce	66 pce 13,20 kg 66 pce
Pro Palette · Per pallet	504 m 604,80 kg 105 box	-	-	-
Mindestabgabereinheit · Min. sales unit	E (pce)	E (pce)	E (pce)	E (pce)
Berechnungseinheit · Calculation unit	Stück · piece	Stück · piece	Stück · piece	Stück · piece
Preisgruppe · Price group	E36	E60	E67	E39

Wegen der unterschiedlichen Produktionsverfahren von Fliesen und Formstücken können leichte Farbabweichungen auftreten.
Due to different production methods used in manufacturing tiles and mouldings there is the possibility that slight colour variations may occur.



5 x 10 cm



10 x 10 cm



10 x 10 cm



5 x 5 cm

Artikelnummer · Article number	3574	3575	3576	3577
Warengruppe · Product group	C300, C360	C300, C360	C300, C360	C300, C360
Werkgröße · Dimensions (mm)	Innenecke · Inside corner 47 x 97 x 6 mm	Aussenecke · Outside corner 97 x 97 x 6 mm	Innenecke · Inside corner 97 x 97 x 6 mm	Aussenecke · Outside corner 47 x 47 x 6 mm
Farbe · Colour	-	-	-	-
Oberfläche · Finish	matt	matt	matt	matt
Erzeugnisgruppe	Steinzeug glasiert	Steinzeug glasiert	Steinzeug glasiert	Steinzeug glasiert
Material	Glazed vitreous	Glazed vitreous	Glazed vitreous	Glazed vitreous
Maßeinheit · Unit of measure	pce 0,20 kg 1 pce	pce 0,17 kg 1 pce	pce 0,17 kg 1 pce	pce 0,09 kg 1 pce
Pro Paket · Per box	54 pce 10,80 kg 54 pce	3 pce 0,51 kg 3 pce	3 pce 0,51 kg 3 pce	2 pce 0,18 kg 2 pce
Pro Palette · Per pallet	-	-	-	-
Mindestabgabereinheit · Min. sales unit	E (pce)	E (pce)	E (pce)	E (pce)
Berechnungseinheit · Calculation unit	Stück · piece	Stück · piece	Stück · piece	Stück · piece
Preisgruppe · Price group	E45	E69	E67	E60

Wegen der unterschiedlichen Produktionsverfahren von Fliesen und Formstücken können leichte Farbabweichungen auftreten.
Due to different production methods used in manufacturing tiles and mouldings there is the possibility that slight colour variations may occur.



5 x 5 cm



5 x 5 cm



10 x 10 cm

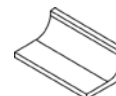

5 x 10 cm

Artikelnummer · Article number	3578	3587	3588	3589
Warengruppe · Product group	C300, C360	C300, C360	C300, C360	C300, C360
Werkgröße · Dimensions (mm)	Innenecke · Inside corner 47 x 47 x 6 mm	Innenecke · Inside corner 47 x 47 x 6 mm	Aussenecke · Outside corner 97 x 97 x 6 mm	Hohlkehlsockel · Cove base 97 x 56 x 6 mm
Farbe · Colour	-	-	-	-
Oberfläche · Finish	matt	matt	matt	matt
Erzeugnisgruppe	Steinzeug glasiert	Steinzeug glasiert	Steinzeug glasiert	Steinzeug glasiert
Material	Glazed vitreous	Glazed vitreous	Glazed vitreous	Glazed vitreous
Maßeinheit · Unit of measure	pce 0,09 kg 1 pce	pce 0,10 kg 1 pce	pce 0,15 kg 1 pce	m 1,20 kg 10 pce
Pro Paket · Per box	2 pce 0,18 kg 2 pce	4 pce 0,40 kg 4 pce	5 pce 0,75 kg 5 pce	4,20 m 5,04 kg 42 pce
Pro Palette · Per pallet	-	-	-	441 m 529,20 kg 105 box
Mindestabgabereinheit · Min. sales unit	E (pce)	E (pce)	E (pce)	E (pce)
Berechnungseinheit · Calculation unit	Stück · piece	Stück · piece	Stück · piece	Stück · piece
Preisgruppe · Price group	E60	E60	E64	E39

Wegen der unterschiedlichen Produktionsverfahren von Fliesen und Formstücken können leichte Farbabweichungen auftreten.
Due to different production methods used in manufacturing tiles and mouldings there is the possibility that slight colour variations may occur.

PRO ARCHITECTURA 3.0

Steinzeug glasiert EN 14411-B1b · Glazed vitreous, EN 14411-B1b

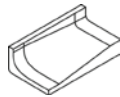

5 x 10 cm

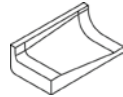

5 x 10 cm

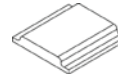

10 x 10 cm

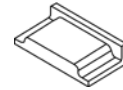

5 x 10 cm

Artikelnummer · Article number	3585	3586	3592	3593
Warengruppe · Product group	C300, C360	C300, C360	C300, C360	C300, C360
Werkgröße · Dimensions (mm)	47 x 97 x 6 mm	47 x 97 x 6 mm	97 x 97 x 6 mm	47 x 97 x 6 mm
Farbe · Colour	-	-	-	-
Oberfläche · Finish	matt	matt	matt	matt
Erzeugnisgruppe	Steinzeug glasiert	Steinzeug glasiert	Steinzeug glasiert	Steinzeug glasiert
Material	Glazed vitreous	Glazed vitreous	Glazed vitreous	Glazed vitreous
Maßeinheit · Unit of measure	pce 0,12 kg 1 pce	pce 0,12 kg 1 pce	m 2 kg 10 pce	pce 0,14 kg 1 pce
Pro Paket · Per box	12 pce 1,44 kg 12 pce	12 pce 1,44 kg 12 pce	2,40 m 4,80 kg 24 pce	15 pce 2,10 kg 15 pce
Pro Palette · Per pallet	-	-	-	-
Mindestabgabereinheit · Min. sales unit	E (pce)	E (pce)	E (pce)	E (pce)
Berechnungseinheit · Calculation unit	Stück · piece	Stück · piece	Stück · piece	Stück · piece
Preisgruppe · Price group	E67	E67	E39	E67

Wegen der unterschiedlichen Produktionsverfahren von Fliesen und Formstücken können leichte Farbabweichungen auftreten.
Due to different production methods used in manufacturing tiles and mouldings there is the possibility that slight colour variations may occur.



10 x 10 cm

Artikelnummer · Article number	3594
Warengruppe · Product group	C300, C360
Werkgröße · Dimensions (mm)	97 x 97 x 6 mm
Farbe · Colour	-
Oberfläche · Finish	matt
Erzeugnisgruppe	Steinzeug glasiert
Material	Glazed vitreous
Maßeinheit · Unit of measure	pce 0,23 kg 1 pce
Pro Paket · Per box	8 pce 1,84 kg 8 pce
Pro Palette · Per pallet	-
Mindestabgabereinheit · Min. sales unit	E (pce)
Berechnungseinheit · Calculation unit	Stück · piece
Preisgruppe · Price group	E67

Wegen der unterschiedlichen Produktionsverfahren von Fliesen und Formstücken können leichte Farbabweichungen auftreten.
Due to different production methods used in manufacturing tiles and mouldings there is the possibility that slight colour variations may occur.

PRO ARCHITECTURA 3.0

Architektur Design (System) · Architecture Design (System)

Concept³

Feinsteinzeug EN 14411-Blä · Porcelain stoneware, EN 14411-Blä

	2,5 x 2,5 cm	2,5 x 2,5 cm	5 x 5 cm	5 x 5 cm
Artikelnummer · Article number	2702	2702	2706	2706
Warengruppe · Product group	C211, C290	C240, C244	C211, C260, C270 C271, C290, C291	C240, C244
Werksmaße · Dimensions (mm)	23 x 23 x 6 mm	23 x 23 x 6 mm	48 x 48 x 6 mm	48 x 48 x 6 mm
Farbe · Colour	-	-	-	-
Oberfläche · Finish	matt Durchgefärbte Keramik · matt Full body porcelain VilbostonePlus	matt Durchgefärbte Keramik · matt Full body porcelain VilbostonePlus	matt Durchgefärbte Keramik · matt Full body porcelain VilbostonePlus	matt Durchgefärbte Keramik · matt Full body porcelain VilbostonePlus
Erzeugnisgruppe	Feinsteinzeug	Feinsteinzeug	Feinsteinzeug	Feinsteinzeug
Material	Porcelain stoneware	Porcelain stoneware	Porcelain stoneware	Porcelain stoneware
Maßeinheit · Unit of measure	m ² 11,55 kg 11 pce	m ² 11,55 kg 11 pce	m ² 11,77 kg 11 pce	m ² 11,77 kg 11 pce
Pro Paket · Per box	1 m ² 11,55 kg 11 pce	1 m ² 11,55 kg 11 pce	1 m ² 11,77 kg 11 pce	1 m ² 11,77 kg 11 pce
Pro Palette · Per pallet	78 m ² 900,90 kg 78 box	78 m ² 900,90 kg 78 box	78 m ² 918,06 kg 78 box	78 m ² 918,06 kg 78 box
Mindestabgabeneinheit · Min. sales unit	P (box)	P (box)	P (box)	P (box)
Berechnungseinheit · Calculation unit	m ²	m ²	m ²	m ²
Preisgruppe · Price group	P157	P160	P119	P134
<p>Für Schachbrettklebung oder wahllose Mischungen kalkulieren Sie auf den Mischpreis der einzusetzenden Artikel mit den format- und mengenbezogenen Preisen, die Sie der Tabelle auf Seite 170 entnehmen können. Achtung: Hierauf werden keine Palettenkonditionen gewährt. Für in Sonderfällen gewünschte Lieferform von losen Fliesen wird ein Aufschlag von 10% berechnet. For chequered arrangements or random mixes, calculate by adding the format- and quantity-related prices found in the table on page 170 to the mixed price for the items to be used. N.B: No pallet terms are granted for these special tiling arrangements. For delivery of single tiles in special cases there will be an additional charge of 10%.</p>				
<p>Die matten Fliesen sind reflexionsfrei und daher für Operationsräume geeignet. The matt tiles are non-reflecting and suitable for use in operating theatres.</p>				
	10 x 10 cm	10 x 10 cm	10 x 10 cm	10 x 10 cm
Artikelnummer · Article number	2200	2200	2205	2205
Warengruppe · Product group	C211, C260, C261 C264, C265, C266 C270, C271, C272 C290, C291	C221, C227, C240 C244, C245, C255 C281	C211, C290	C240, C244
Werksmaße · Dimensions (mm)	97 x 97 x 6 mm	97 x 97 x 6 mm	97 x 97 x 6 mm	97 x 97 x 6 mm
Farbe · Colour	-	-	-	-
Oberfläche · Finish	matt Durchgefärbte Keramik · matt Full body porcelain VilbostonePlus	matt Durchgefärbte Keramik · matt Full body porcelain VilbostonePlus	matt Durchgefärbte Keramik · matt Full body porcelain VilbostonePlus	matt Durchgefärbte Keramik · matt Full body porcelain VilbostonePlus
Erzeugnisgruppe	Feinsteinzeug	Feinsteinzeug	Feinsteinzeug	Feinsteinzeug
Material	Porcelain stoneware	Porcelain stoneware	Porcelain stoneware	Porcelain stoneware
Maßeinheit · Unit of measure	m ² 12,54 kg 11 pce	m ² 12,54 kg 11 pce	m ² 12,54 kg 11 pce	m ² 12,54 kg 11 pce
Pro Paket · Per box	1 m ² 12,54 kg 11 pce	1 m ² 12,54 kg 11 pce	1 m ² 12,54 kg 11 pce	1 m ² 12,54 kg 11 pce
Pro Palette · Per pallet	78 m ² 978,12 kg 78 box	78 m ² 978,12 kg 78 box	78 m ² 978,12 kg 78 box	78 m ² 978,12 kg 78 box
Mindestabgabeneinheit · Min. sales unit	P (box)	P (box)	P (box)	P (box)
Berechnungseinheit · Calculation unit	m ²	m ²	m ²	m ²
Preisgruppe · Price group	P119	P134	P118	P134
<p>Für Schachbrettklebung oder wahllose Mischungen kalkulieren Sie auf den Mischpreis der einzusetzenden Artikel mit den format- und mengenbezogenen Preisen, die Sie der Tabelle auf Seite 170 entnehmen können. Achtung: Hierauf werden keine Palettenkonditionen gewährt. Für in Sonderfällen gewünschte Lieferform von losen Fliesen wird ein Aufschlag von 10% berechnet. For chequered arrangements or random mixes, calculate by adding the format- and quantity-related prices found in the table on page 170 to the mixed price for the items to be used. N.B: No pallet terms are granted for these special tiling arrangements. For delivery of single tiles in special cases there will be an additional charge of 10%.</p>				
<p>Die matten Fliesen sind reflexionsfrei und daher für Operationsräume geeignet. The matt tiles are non-reflecting and suitable for use in operating theatres.</p>				

PRO ARCHITECTURA 3.0

Feinsteinzeug EN 14411-Bla · Porcelain stoneware, EN 14411-Bla

Artikelnummer · Article number	2405	2247	2247	2248
Warengruppe · Product group	C211, C260, C270 C271, C290, C291	C211, C290	C240, C244	C211, C260, C270 C271, C290, C291
Werksmaße · Dimensions (mm)	Grundfliese · Basic tile 147 x 147 x 8,20 mm	Grundfliese · Basic tile 196 x 196 x 8,20 mm	Grundfliese · Basic tile 196 x 196 x 8,20 mm	Grundfliese · Basic tile 196 x 196 x 8,20 mm
Farbe · Colour	-	-	-	-
Oberfläche · Finish	matt Durchgefärbte Keramik · matt Full body porcelain VilbostonePlus	matt Durchgefärbte Keramik · matt Full body porcelain VilbostonePlus	matt Durchgefärbte Keramik · matt Full body porcelain VilbostonePlus	matt Durchgefärbte Keramik · matt Full body porcelain VilbostonePlus
Erzeugnisgruppe	Feinsteinzeug	Feinsteinzeug	Feinsteinzeug	Feinsteinzeug
Material	Porcelain stoneware	Porcelain stoneware	Porcelain stoneware	Porcelain stoneware
Maßeinheit · Unit of measure	m ² 17,16 kg 44 pce	m ² 17,75 kg 25 pce	m ² 17,75 kg 25 pce	m ² 17,75 kg 25 pce
Pro Paket · Per box	0,75 m ² 12,87 kg 33 pce	1,20 m ² 21,30 kg 30 pce	1,20 m ² 21,30 kg 30 pce	1,20 m ² 21,30 kg 30 pce
Pro Palette · Per pallet	60 m ² 1029,60 kg 80 box	60 m ² 1065 kg 50 box	60 m ² 1065 kg 50 box	60 m ² 1065 kg 50 box
Mindestabgabereinheit · Min. sales unit	P (box)	P (box)	P (box)	P (box)
Berechnungseinheit · Calculation unit	m ²	m ²	m ²	m ²
Preisgruppe · Price group	P110	P104	P114	P103
Artikelnummer · Article number	2248	2213	2073	2073
Warengruppe · Product group	C240, C244	C211, C260, C270 C271, C290, C291	C211, C221, C227 C281, C290, C291	C240, C244, C245 C255, C260, C261 C264, C265, C266 C270, C271, C272
Werksmaße · Dimensions (mm)	Grundfliese · Basic tile 196 x 196 x 8,20 mm	Grundfliese · Basic tile 297 x 297 x 8,20 mm	Innenecke · Inside corner 21 x 106 x 6 mm	Innenecke · Inside corner 21 x 106 x 6 mm
Farbe · Colour	-	-	-	-
Oberfläche · Finish	matt Durchgefärbte Keramik · matt Full body porcelain VilbostonePlus	matt Durchgefärbte Keramik · matt Full body porcelain VilbostonePlus	matt Durchgefärbte Keramik · matt Full body porcelain VilbostonePlus	matt Durchgefärbte Keramik · matt Full body porcelain VilbostonePlus
Erzeugnisgruppe	Feinsteinzeug	Feinsteinzeug	Feinsteinzeug	Feinsteinzeug
Material	Porcelain stoneware	Porcelain stoneware	Porcelain stoneware	Porcelain stoneware
Maßeinheit · Unit of measure	m ² 17,75 kg 25 pce	m ² 17,60 kg 11 pce	pce 0,08 kg 1 pce 20 pce 1,60 kg 20 pce	pce 0,08 kg 1 pce 20 pce 1,60 kg 20 pce
Pro Paket · Per box	1,20 m ² 21,30 kg 30 pce	1 m ² 17,60 kg 11 pce	20 pce 1,60 kg 20 pce	20 pce 1,60 kg 20 pce
Pro Palette · Per pallet	60 m ² 1065 kg 50 box	60 m ² 1056 kg 60 box	-	-
Mindestabgabereinheit · Min. sales unit	P (box)	P (box)	E (pce)	E (pce)
Berechnungseinheit · Calculation unit	m ²	m ²	Stück · piece	Stück · piece
Preisgruppe · Price group	P114	P98	E36	E36
Wegen der unterschiedlichen Produktionsverfahren von Fliesen und Formstücken können leichte Farbabweichungen auftreten. Due to different production methods used in manufacturing tiles and mouldings there is the possibility that slight colour variations may occur.				
Artikelnummer · Article number	2074	2074	2072	2072
Warengruppe · Product group	C211, C221, C227 C281, C290, C291	C240, C244, C245 C255, C260, C261 C264, C265, C266 C270, C271, C272	C211, C221, C227 C281, C290, C291	C240, C244, C245 C255, C260, C261 C264, C265, C266 C270, C271, C272
Werksmaße · Dimensions (mm)	Aussenecke · Outside corner 36 x 106 x 6 mm	Aussenecke · Outside corner 36 x 106 x 6 mm	Hohlkehlssockel · Cove base 97 x 106 x 6 mm	Hohlkehlssockel · Cove base 97 x 106 x 6 mm
Farbe · Colour	-	-	-	-
Oberfläche · Finish	matt Durchgefärbte Keramik · matt Full body porcelain VilbostonePlus	matt Durchgefärbte Keramik · matt Full body porcelain VilbostonePlus	matt Durchgefärbte Keramik · matt Full body porcelain VilbostonePlus	matt Durchgefärbte Keramik · matt Full body porcelain VilbostonePlus
Erzeugnisgruppe	Feinsteinzeug	Feinsteinzeug	Feinsteinzeug	Feinsteinzeug
Material	Porcelain stoneware	Porcelain stoneware	Porcelain stoneware	Porcelain stoneware
Maßeinheit · Unit of measure	pce 0,10 kg 1 pce	pce 0,10 kg 1 pce	m 1,50 kg 10 pce 5 m 7,50 kg 50 pce	m 1,50 kg 10 pce 5 m 7,50 kg 50 pce
Pro Paket · Per box	24 pce 2,40 kg 24 pce	24 pce 2,40 kg 24 pce	525 m 787,50 kg 105 box	525 m 787,50 kg 105 box
Pro Palette · Per pallet	-	-	-	-
Mindestabgabereinheit · Min. sales unit	E (pce)	E (pce)	E (pce)	E (pce)
Berechnungseinheit · Calculation unit	Stück · piece	Stück · piece	Stück · piece	Stück · piece
Preisgruppe · Price group	E36	E36	E16	E16
Wegen der unterschiedlichen Produktionsverfahren von Fliesen und Formstücken können leichte Farbabweichungen auftreten. Due to different production methods used in manufacturing tiles and mouldings there is the possibility that slight colour variations may occur.				

PRO ARCHITECTURA 3.0

Architektur Design (System) · Architecture Design (System)

Concept³

Feinsteinzeug EN 14411-Bla · Porcelain stoneware, EN 14411-Bla

	 5 x 5 cm 247 x 47 mm 5 pce Formstücke für Duschwannen Moulded pieces for showers	 5 x 5 cm 247 x 47 mm 5 pce Formstücke für Duschwannen Moulded pieces for showers	 5 x 5 cm 247 x 47 mm 5 pce Formstücke für Duschwannen Moulded pieces for showers	 10 x 10 cm
Artikelnummer · Article number	2731	2765	2772	2607
Warengruppe · Product group	C211, C290 ◆ Randfliese · Bullnose	C211, C290 ◆ Innenecke · Inside corner	C211, C290 ◆ Hohlkehlsoclel · Cove base	C211, C260 ◆ Läufer · Running piece
Werksmaße · Dimensions (mm)	47 x 47 x 6 mm	55 x 55 x 6 mm	47 x 55 x 6 mm	97 x 97 x 6 mm
Farbe · Colour	-	-	-	-
Oberfläche · Finish	matt VilbostonePlus	matt VilbostonePlus	matt VilbostonePlus	matt VilbostonePlus
Erzeugnisgruppe	Feinsteinzeug	Feinsteinzeug	Feinsteinzeug	Feinsteinzeug
Material	Porcelain stoneware	Porcelain stoneware	Porcelain stoneware	Porcelain stoneware
Maßeinheit · Unit of measure	m 0,60 kg 4 pce	pce 0,04 kg 1 pce	m 0,72 kg 4 pce	m 2,10 kg 10 pce
Pro Paket · Per box	3 m 1,80 kg 12 pce	12 pce 0,48 kg 12 pce	3 m 2,16 kg 12 pce	4,20 m 8,82 kg 42 pce
Pro Palette · Per pallet	-	9996 pce 399,84 kg 833 box	1008 m 725,76 kg 336 box	441 m 926,10 kg 105 box
Mindestabgabereinheit · Min. sales unit	E (pce)	E (pce)	E (pce)	E (pce)
Berechnungseinheit · Calculation unit	Stück · piece	Stück · piece	Stück · piece	Stück · piece
Preisgruppe · Price group	E36	E29	E41	E45
Wegen der unterschiedlichen Produktionsverfahren von Fliesen und Formstücken können leichte Farbabweichungen auftreten. Due to different production methods used in manufacturing tiles and mouldings there is the possibility that slight colour variations may occur.				
Für in Sonderfällen gewünschte Lieferform von losen Fliesen wird ein Aufschlag von 10% berechnet. For delivery of single tiles in special cases there will be an additional charge of 10%.		Für in Sonderfällen gewünschte Lieferform von losen Fliesen wird ein Aufschlag von 10% berechnet. For delivery of single tiles in special cases there will be an additional charge of 10%.		
	 10 x 10 cm			
Artikelnummer · Article number	2609			
Warengruppe · Product group	C211, C260 ◆ Ecke · Corner			
Werksmaße · Dimensions (mm)	97 x 97 x 6 mm			
Farbe · Colour	-			
Oberfläche · Finish	matt VilbostonePlus			
Erzeugnisgruppe	Feinsteinzeug			
Material	Porcelain stoneware			
Maßeinheit · Unit of measure	pce 0,21 kg 1 pce			
Pro Paket · Per box	30 pce 6,30 kg 30 pce			
Pro Palette · Per pallet	3150 pce 661,50 kg 105 box			
Mindestabgabereinheit · Min. sales unit	E (pce)			
Berechnungseinheit · Calculation unit	Stück · piece			
Preisgruppe · Price group	E67			
Wegen der unterschiedlichen Produktionsverfahren von Fliesen und Formstücken können leichte Farbabweichungen auftreten. Due to different production methods used in manufacturing tiles and mouldings there is the possibility that slight colour variations may occur.				

PRO ARCHITECTURA 3.0

Feinsteinzeug EN 14411-Bla · Porcelain stoneware, EN 14411-Bla

	5 x 5 cm	10 x 10 cm	15 x 15 cm	15 x 15 cm
	□ 0,09 m ² 297 x 297 mm	□ 0,09 m ² 297 x 297 mm		
Artikelnummer · Article number	2706	2200	2119	2120
	C411, C460, C471 C490, C491	C411, C460, C461 C464, C465, C466 C471, C472, C490 C491	C411, C460, C471 C490, C491	C411, C460, C471 C490, C491
	✳️ R10 B ✳️ R10 B	✳️ R10 B ✳️ R10 B ✳️ R10 B ✳️ R10 B	✳️ R11 B ✳️ R11 B	✳️ R12 ✳️ R12
Warengruppe · Product group	Grundfliese · Basic tile	Grundfliese · Basic tile	Grundfliese · Basic tile	Grundfliese · Basic tile
Werkmaße · Dimensions (mm)	48 x 48 x 6 mm	97 x 97 x 6 mm	146 x 146 x 8,20 mm	146 x 146 x 8,20 mm
Farbe · Colour	-	-	-	-
Oberfläche · Finish	matt durchgefärbte feine Granitstruktur · matt Full-body-coloured, fine granite structure VilbostonePlus	matt durchgefärbte feine Granitstruktur · matt Full-body-coloured, fine granite structure VilbostonePlus	matt durchgefärbte feine Granitstruktur · matt Full-body-coloured, fine granite structure VilbostonePlus	matt durchgefärbte feine Granitstruktur · matt Full-body-coloured, fine granite structure VilbostonePlus
Erzeugnisgruppe	Feinsteinzeug	Feinsteinzeug	Feinsteinzeug	Feinsteinzeug
Material	Porcelain stoneware	Porcelain stoneware	Porcelain stoneware	Porcelain stoneware
Maßeinheit · Unit of measure	m ² 11,77 kg 11 pce	m ² 12,54 kg 11 pce	m ² 17,16 kg 44 pce	m ² 17,16 kg 44 pce
Pro Paket · Per box	1 m ² 11,77 kg 11 pce	1 m ² 12,54 kg 11 pce	0,75 m ² 12,87 kg 33 pce	0,75 m ² 12,87 kg 33 pce
Pro Palette · Per pallet	78 m ² 918,06 kg 78 box	78 m ² 978,12 kg 78 box	60 m ² 1029,60 kg 80 box	60 m ² 1029,60 kg 80 box
Mindestabgabereinheit · Min. sales unit	P (box)	P (box)	P (box)	P (box)
Berechnungseinheit · Calculation unit	m ²	m ²	m ²	m ²
Preisgruppe · Price group	P119	P120	P121	P121
	Für Schachbrettklebung oder wahllose Mischungen kalkulieren Sie auf den Mischpreis der einzusetzenden Artikel mit den format- und mengenbezogenen Preisen, die Sie der Tabelle auf Seite 170 entnehmen können. Achtung: Hierauf werden keine Palettenkonditionen gewährt. Für in Sonderfällen gewünschte Lieferform von losen Fliesen wird ein Aufschlag von 10% berechnet. For chequered arrangements or random mixes, calculate by adding the format- and quantity-related prices found in the table on page 170 to the mixed price for the items to be used. N.B: No pallet terms are granted for these special tiling arrangements. For delivery of single tiles in special cases there will be an additional charge of 10%.	Für Schachbrettklebung oder wahllose Mischungen kalkulieren Sie auf den Mischpreis der einzusetzenden Artikel mit den format- und mengenbezogenen Preisen, die Sie der Tabelle auf Seite 170 entnehmen können. Achtung: Hierauf werden keine Palettenkonditionen gewährt. Für in Sonderfällen gewünschte Lieferform von losen Fliesen wird ein Aufschlag von 10% berechnet. For chequered arrangements or random mixes, calculate by adding the format- and quantity-related prices found in the table on page 170 to the mixed price for the items to be used. N.B: No pallet terms are granted for these special tiling arrangements. For delivery of single tiles in special cases there will be an additional charge of 10%.	Für Schachbrettklebung oder wahllose Mischungen kalkulieren Sie auf den Mischpreis der einzusetzenden Artikel mit den format- und mengenbezogenen Preisen, die Sie der Tabelle auf Seite 170 entnehmen können. Achtung: Hierauf werden keine Palettenkonditionen gewährt. Für in Sonderfällen gewünschte Lieferform von losen Fliesen wird ein Aufschlag von 10% berechnet. For chequered arrangements or random mixes, calculate by adding the format- and quantity-related prices found in the table on page 170 to the mixed price for the items to be used. N.B: No pallet terms are granted for these special tiling arrangements. For delivery of single tiles in special cases there will be an additional charge of 10%.	Für Schachbrettklebung oder wahllose Mischungen kalkulieren Sie auf den Mischpreis der einzusetzenden Artikel mit den format- und mengenbezogenen Preisen, die Sie der Tabelle auf Seite 170 entnehmen können. Achtung: Hierauf werden keine Palettenkonditionen gewährt. Für in Sonderfällen gewünschte Lieferform von losen Fliesen wird ein Aufschlag von 10% berechnet. For chequered arrangements or random mixes, calculate by adding the format- and quantity-related prices found in the table on page 170 to the mixed price for the items to be used. N.B: No pallet terms are granted for these special tiling arrangements. For delivery of single tiles in special cases there will be an additional charge of 10%.
	15 x 15 cm	15 x 15 cm	20 x 20 cm	20 x 20 cm
Artikelnummer · Article number	2215	2219	2121	2122
	C411, C460, C471 C490, C491	C411, C460, C471 C490, C491	C411, C460, C471 C490, C491	C411, C460, C471 C490, C491
	✳️ R10 B ✳️ R10 B	✳️ R12 -V4 B ✳️ R12 -V4 B	✳️ R11 B ✳️ R11 B	✳️ R12 ✳️ R12
Warengruppe · Product group	Grundfliese · Basic tile	Grundfliese · Basic tile	Grundfliese · Basic tile	Grundfliese · Basic tile
Werkmaße · Dimensions (mm)	146 x 146 x 8,20 mm	146 x 146 x 8,20 mm	196 x 196 x 8,20 mm	196 x 196 x 8,20 mm
Farbe · Colour	-	-	-	-
Oberfläche · Finish	matt durchgefärbte feine Granitstruktur · matt Full-body-coloured, fine granite structure VilbostonePlus	matt durchgefärbte feine Granitstruktur · matt Full-body-coloured, fine granite structure VilbostonePlus	matt durchgefärbte feine Granitstruktur · matt Full-body-coloured, fine granite structure VilbostonePlus	matt durchgefärbte feine Granitstruktur · matt Full-body-coloured, fine granite structure VilbostonePlus
Erzeugnisgruppe	Feinsteinzeug	Feinsteinzeug	Feinsteinzeug	Feinsteinzeug
Material	Porcelain stoneware	Porcelain stoneware	Porcelain stoneware	Porcelain stoneware
Maßeinheit · Unit of measure	m ² 17,16 kg 44 pce	m ² 17,16 kg 44 pce	m ² 17,50 kg 25 pce	m ² 17,50 kg 25 pce
Pro Paket · Per box	0,75 m ² 12,87 kg 33 pce	0,75 m ² 12,87 kg 33 pce	1,20 m ² 21 kg 30 pce	1,20 m ² 21 kg 30 pce
Pro Palette · Per pallet	60 m ² 1029,60 kg 80 box	60 m ² 1029,60 kg 80 box	60 m ² 1050 kg 50 box	60 m ² 1050 kg 50 box
Mindestabgabereinheit · Min. sales unit	P (box)	P (box)	P (box)	P (box)
Berechnungseinheit · Calculation unit	m ²	m ²	m ²	m ²
Preisgruppe · Price group	P121	P121	P100	P100

PRO ARCHITECTURA 3.0

Architektur Design (System) · Architecture Design (System)

Concept³

Feinsteinzeug EN 14411-Bla · Porcelain stoneware, EN 14411-Bla

20 x 20 cm	20 x 20 cm	30 x 30 cm	30 x 30 cm
2253	2600	2118	2213
C411, C460, C471 C490, C491	C411, C460, C471 C490, C491	C411, C460, C471 C490, C491	C411, C460, C471 C490, C491
Grundfliese · Basic tile	Grundfliese · Basic tile	Grundfliese · Basic tile	Grundfliese · Basic tile
196 x 196 x 8,20 mm	196 x 196 x 8,20 mm	296 x 296 x 8,20 mm	297 x 297 x 8,20 mm
-	-	-	-
matt durchgefärbte feine Granitstruktur · matt Full-body-coloured, fine granite structure VilbostonePlus	matt durchgefärbte feine Granitstruktur · matt Full-body-coloured, fine granite structure VilbostonePlus	matt durchgefärbte feine Granitstruktur · matt Full-body-coloured, fine granite structure VilbostonePlus	matt durchgefärbte feine Granitstruktur · matt Full-body-coloured, fine granite structure VilbostonePlus
Feinsteinzeug	Feinsteinzeug	Feinsteinzeug	Feinsteinzeug
Porcelain stoneware	Porcelain stoneware	Porcelain stoneware	Porcelain stoneware
m ² 17,50 kg 25 pce	m ² 17,50 kg 25 pce	m ² 17,60 kg 11 pce	m ² 17,60 kg 11 pce
1,20 m ² 21 kg 30 pce	1,20 m ² 21 kg 30 pce	1 m ² 17,60 kg 11 pce	1 m ² 17,60 kg 11 pce
60 m ² 1050 kg 50 box	60 m ² 1050 kg 50 box	60 m ² 1056 kg 60 box	60 m ² 1056 kg 60 box
P (box)	P (box)	P (box)	P (box)
m ²	m ²	m ²	m ²
P100	P100	P123	P99
30 x 30 cm	30 x 60 cm	60 x 60 cm	30 x 60 cm
2214	2218	2014	2231
C411, C460, C471 C490, C491	C411, C460, C471 C490, C491	C411, C460, C471 C490, C491	C411, C460, C471 C490, C491
Grundfliese · Basic tile	Grundfliese · Basic tile	Grundfliese · Basic tile	Treppenauftritt · Stair tread
296 x 296 x 9 mm	296 x 596 x 9 mm	596 x 596 x 9 mm	296 x 596 x 9 mm
-	-	-	-
matt durchgefärbte feine Granitstruktur · matt Full-body-coloured, fine granite structure VilbostonePlus	matt durchgefärbte feine Granitstruktur · matt Full-body-coloured, fine granite structure VilbostonePlus	matt durchgefärbte feine Granitstruktur · matt Full-body-coloured, fine granite structure VilbostonePlus	matt durchgefärbte feine Granitstruktur · matt Full-body-coloured, fine granite structure VilbostonePlus
Feinsteinzeug	Feinsteinzeug	Feinsteinzeug	Feinsteinzeug
Porcelain stoneware	Porcelain stoneware	Porcelain stoneware	Porcelain stoneware
m ² 19,25 kg 11 pce	m ² 18,67 kg 5,56 pce	m ² 19,72 kg 2,78 pce	m 5,61 kg 1,67 pce
1 m ² 19,25 kg 11 pce	1,08 m ² 20,16 kg 6 pce	1,08 m ² 21,30 kg 3 pce	3,59 m 20,16 kg 6 pce
56 m ² 1078 kg 56 box	43,20 m ² 806,40 kg 40 box	43,20 m ² 852 kg 40 box	143,71 m 806,40 kg 40 box
P (box)	P (box)	P (box)	E (pce)
m ²	m ²	m ²	Stück · piece
P99	P89	P117	E93

Auftragsbezogene Fertigung der Treppen in der zu bestellten Grundfliese passenden Nuance. Lieferzeit auf Anfrage.
Steps made to order in the nuance that matches the basic tile ordered. Delivery time on request.

PRO ARCHITECTURA 3.0

Feinsteinzeug EN 14411-Bla · Porcelain stoneware, EN 14411-Bla



Artikelnummer · Article number
Warengruppe · Product group
Werkmaße · Dimensions (mm)
Farbe · Colour
Oberfläche · Finish
Erzeugnisgruppe
Material
Maßeinheit · Unit of measure
Pro Paket · Per box
Pro Palette · Per pallet
Mindestabgabeneinheit · Min. sales unit
Berechnungseinheit · Calculation unit
Preisgruppe · Price group

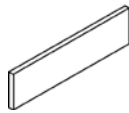

7,5 x 30 cm

2232
C411, C460, C461 C464, C465, C466 C471, C472, C490 C491
☼ R10 A ◆
☼ R10 A ◆
☼ R10 A ◆
☼ R10 A ◆
Sockel · Skirting
71 x 296 x 8,20 mm
-
matt durchgefärbte feine Granitstruktur · matt Full-body-coloured, fine granite structure
VilbostonePlus
Feinsteinzeug
Porcelain stoneware
m 1,50 kg 3,33 pce
9,61 m 14,40 kg 32 pce
-
E (pce)
Stück · piece
E23



10 x 10 cm

2072
C411, C460, C461 C464, C465, C466 C471, C472, C490 C491
☼ R10 B ◆
☼ R10 B ◆
☼ R10 B ◆
☼ R10 B ◆
Hohlkehlsockel · Cove base
97 x 106 x 6 mm
-
matt durchgefärbte feine Granitstruktur · matt Full-body-coloured, fine granite structure
VilbostonePlus
Feinsteinzeug
Porcelain stoneware
m 1,50 kg 10 pce
5 m 7,50 kg 50 pce
525 m 787,50 kg 105 box
E (pce)
Stück · piece
E15



10 x 15 cm

2263
C411, C460, C471 C490, C491
☼ R10 B ◆
☼ R10 B ◆
Hohlkehlsockel · Cove base
108,20 x 146 x 8,20 mm
-
matt durchgefärbte feine Granitstruktur · matt Full-body-coloured, fine granite structure
VilbostonePlus
Feinsteinzeug
Porcelain stoneware
m 2,80 kg 6,67 pce
6 m 16,80 kg 40 pce
419,79 m 1176 kg 70 box
E (pce)
Stück · piece
E23

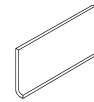

10 x 20 cm

2495
C411, C460, C471 C490, C491
☼ R10 B ◆
☼ R10 B ◆
Hohlkehlsockel · Cove base
108,20 x 197 x 8,20 mm
-
matt durchgefärbte feine Granitstruktur · matt Full-body-coloured, fine granite structure
VilbostonePlus
Feinsteinzeug
Porcelain stoneware
m 1,90 kg 5 pce
4 m 7,60 kg 20 pce
420 m 798 kg 105 box
E (pce)
Stück · piece
E32

Wegen der unterschiedlichen Produktionsverfahren von Fliesen und Formstücken können leichte Farbabweichungen auftreten.
Due to different production methods used in manufacturing tiles and mouldings there is the possibility that slight colour variations may occur.



2 x 10 cm

2073
C411, C460, C461 C464, C465, C466 C471, C472, C490 C491
☼ ◆
☼ ◆
☼ ◆
☼ ◆
Innenecke · Inside corner
21 x 106 x 6 mm
-
matt durchgefärbte feine Granitstruktur · matt Full-body-coloured, fine granite structure
VilbostonePlus
Feinsteinzeug
Porcelain stoneware
pce 0,08 kg 1 pce
20 pce 1,60 kg 20 pce
-
E (pce)
Stück · piece
E36



3 x 10 cm

2074
C411, C460, C461 C464, C465, C466 C471, C472, C490 C491
☼ ◆
☼ ◆
☼ ◆
☼ ◆
Aussenecke · Outside corner
36 x 106 x 6 mm
-
matt durchgefärbte feine Granitstruktur · matt Full-body-coloured, fine granite structure
VilbostonePlus
Feinsteinzeug
Porcelain stoneware
pce 0,10 kg 1 pce
24 pce 2,40 kg 24 pce
-
E (pce)
Stück · piece
E36



10 x 10 cm

2607
C411, C460, C471 C490, C491
☼ R10 B ◆
☼ R10 B ◆
Läufer · Running piece
97 x 97 x 6 mm
-
matt durchgefärbte feine Granitstruktur · matt Full-body-coloured, fine granite structure
VilbostonePlus
Feinsteinzeug
Porcelain stoneware
m 2,10 kg 10 pce
4,20 m 8,82 kg 42 pce
441 m 926,10 kg 105 box
E (pce)
Stück · piece
E45

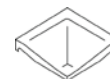

10 x 10 cm

2609
C411, C460, C471 C490, C491
☼ R10 B ◆
☼ R10 B ◆
Ecke · Corner
97 x 97 x 6 mm
-
matt durchgefärbte feine Granitstruktur · matt Full-body-coloured, fine granite structure
VilbostonePlus
Feinsteinzeug
Porcelain stoneware
pce 0,21 kg 1 pce
30 pce 6,30 kg 30 pce
-
E (pce)
Stück · piece
E67

Wegen der unterschiedlichen Produktionsverfahren von Fliesen und Formstücken können leichte Farbabweichungen auftreten.
Due to different production methods used in manufacturing tiles and mouldings there is the possibility that slight colour variations may occur.



30 x 30 cm

2225
C411, C491
☼ R11 B ◆
Grundfliese · Basic tile
296 x 296 x 8,20 mm
-
matt durchgefärbte feine Granitstruktur · matt Full-body-coloured, fine granite structure
VilbostonePlus
Feinsteinzeug
Porcelain stoneware
pce 1,64 kg 1 pce
8 pce 13,12 kg 8 pce
480 pce 787,20 kg 60 box
E (pce)
Stück · piece
E45

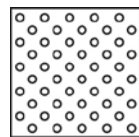

30 x 30 cm

2226
C411, C491
☼ R11 B ◆
Grundfliese · Basic tile
296 x 296 x 8,20 mm
-
matt durchgefärbte feine Granitstruktur · matt Full-body-coloured, fine granite structure
VilbostonePlus
Feinsteinzeug
Porcelain stoneware
pce 1,64 kg 1 pce
8 pce 13,12 kg 8 pce
480 pce 787,20 kg 60 box
E (pce)
Stück · piece
E45

Nur für Innenverlegung
Only for indoor use

Nur für Innenverlegung
Only for indoor use

PRO ARCHITECTURA 3.0 Pool System

Architektur Design (System) · Architecture Design (System)

Finnisches Überflutungssystem / Wasserspiegel hochliegend Finnish overflow system / high-level system



12 x 20 cm

Artikelnummer · Article number	3010
Warengruppe · Product group	Griffmulde · Grip trough
Werksmaße · Dimensions (mm)	115 x 195 x 15 mm
Farbe · Colour	→ siehe Seite see page 229
Oberfläche · Finish	matt
Erzeugnisgruppe	Feinsteinzeug glasiert
Material	Glazed porcelain stoneware
Maßeinheit · Unit of measure	pce 0,85 kg 1 pce
Pro Paket · Per box	-
Pro Palette · Per pallet	-
Mindestabgabereinheit · Min. sales unit	E (pce)
Berechnungseinheit · Calculation unit	Stück · piece
Preisgruppe · Price group	E78



12 x 12 cm

Artikelnummer · Article number	3012
Warengruppe · Product group	Innenecke · Inside corner
Werksmaße · Dimensions (mm)	115 x 115 x 15 mm
Farbe · Colour	→ siehe Seite see page 229
Oberfläche · Finish	matt
Erzeugnisgruppe	Feinsteinzeug glasiert
Material	Glazed porcelain stoneware
Maßeinheit · Unit of measure	pce 0,56 kg 1 pce
Pro Paket · Per box	-
Pro Palette · Per pallet	-
Mindestabgabereinheit · Min. sales unit	E (pce)
Berechnungseinheit · Calculation unit	Stück · piece
Preisgruppe · Price group	E103



20 x 20 cm

Artikelnummer · Article number	3013
Warengruppe · Product group	Aussenecke · Outside corner
Werksmaße · Dimensions (mm)	195 x 195 x 15 mm
Farbe · Colour	→ siehe Seite see page 229
Oberfläche · Finish	matt
Erzeugnisgruppe	Feinsteinzeug glasiert
Material	Glazed porcelain stoneware
Maßeinheit · Unit of measure	pce 1,28 kg 1 pce
Pro Paket · Per box	-
Pro Palette · Per pallet	-
Mindestabgabereinheit · Min. sales unit	E (pce)
Berechnungseinheit · Calculation unit	Stück · piece
Preisgruppe · Price group	E123



3,2 x 20 cm

Artikelnummer · Article number	3011
Warengruppe · Product group	Rostauflegewinkel · Grating support
Werksmaße · Dimensions (mm)	33 x 195 x 8 mm
Farbe · Colour	neutral white
Oberfläche · Finish	matt
Erzeugnisgruppe	Feinsteinzeug glasiert
Material	Glazed porcelain stoneware
Maßeinheit · Unit of measure	pce 0,16 kg 1 pce
Pro Paket · Per box	-
Pro Palette · Per pallet	-
Mindestabgabereinheit · Min. sales unit	E (pce)
Berechnungseinheit · Calculation unit	Stück · piece
Preisgruppe · Price group	E41



12 x 20 cm

Artikelnummer · Article number	3020
Warengruppe · Product group	Griffmulde · Grip trough
Werksmaße · Dimensions (mm)	115 x 195 x 15 mm
Farbe · Colour	→ siehe Seite see page 229
Oberfläche · Finish	matt
Erzeugnisgruppe	Feinsteinzeug glasiert
Material	Glazed porcelain stoneware
Maßeinheit · Unit of measure	pce 1,04 kg 1 pce
Pro Paket · Per box	-
Pro Palette · Per pallet	-
Mindestabgabereinheit · Min. sales unit	E (pce)
Berechnungseinheit · Calculation unit	Stück · piece
Preisgruppe · Price group	E81



12 x 12 cm

Artikelnummer · Article number	3021
Warengruppe · Product group	Innenecke · Inside corner
Werksmaße · Dimensions (mm)	115 x 115 x 15 mm
Farbe · Colour	→ siehe Seite see page 229
Oberfläche · Finish	matt
Erzeugnisgruppe	Feinsteinzeug glasiert
Material	Glazed porcelain stoneware
Maßeinheit · Unit of measure	pce 0,56 kg 1 pce
Pro Paket · Per box	-
Pro Palette · Per pallet	-
Mindestabgabereinheit · Min. sales unit	E (pce)
Berechnungseinheit · Calculation unit	Stück · piece
Preisgruppe · Price group	E105

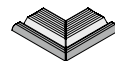

20 x 20 cm

Artikelnummer · Article number	3022
Warengruppe · Product group	Aussenecke · Outside corner
Werksmaße · Dimensions (mm)	195 x 195 x 15 mm
Farbe · Colour	→ siehe Seite see page 229
Oberfläche · Finish	matt
Erzeugnisgruppe	Feinsteinzeug glasiert
Material	Glazed porcelain stoneware
Maßeinheit · Unit of measure	pce 1,60 kg 1 pce
Pro Paket · Per box	-
Pro Palette · Per pallet	-
Mindestabgabereinheit · Min. sales unit	E (pce)
Berechnungseinheit · Calculation unit	Stück · piece
Preisgruppe · Price group	E127



12 x 20 cm

Artikelnummer · Article number	3014
Warengruppe · Product group	Rostaufleger · Grating support
Werksmaße · Dimensions (mm)	115 x 195 x 15 mm
Farbe · Colour	-
Oberfläche · Finish	matt
Erzeugnisgruppe	Feinsteinzeug glasiert
Material	Glazed porcelain stoneware
Maßeinheit · Unit of measure	pce 0,96 kg 1 pce
Pro Paket · Per box	-
Pro Palette · Per pallet	-
Mindestabgabereinheit · Min. sales unit	E (pce)
Berechnungseinheit · Calculation unit	Stück · piece
Preisgruppe · Price group	E92



12 x 12 cm

Artikelnummer · Article number	3015
Warengruppe · Product group	Innenecke · Inside corner
Werksmaße · Dimensions (mm)	115 x 115 x 15 mm
Farbe · Colour	-
Oberfläche · Finish	matt
Erzeugnisgruppe	Feinsteinzeug glasiert
Material	Glazed porcelain stoneware
Maßeinheit · Unit of measure	pce 1 kg 1 pce
Pro Paket · Per box	-
Pro Palette · Per pallet	-
Mindestabgabereinheit · Min. sales unit	E (pce)
Berechnungseinheit · Calculation unit	Stück · piece
Preisgruppe · Price group	E142



20 x 20 cm

Artikelnummer · Article number	3016
Warengruppe · Product group	Aussenecke · Outside corner
Werksmaße · Dimensions (mm)	195 x 195 x 15 mm
Farbe · Colour	-
Oberfläche · Finish	matt
Erzeugnisgruppe	Feinsteinzeug glasiert
Material	Glazed porcelain stoneware
Maßeinheit · Unit of measure	pce 1,60 kg 1 pce
Pro Paket · Per box	-
Pro Palette · Per pallet	-
Mindestabgabereinheit · Min. sales unit	E (pce)
Berechnungseinheit · Calculation unit	Stück · piece
Preisgruppe · Price group	E142



12 x 20 cm

Artikelnummer · Article number	3017
Warengruppe · Product group	Rostaufleger · Grating support
Werksmaße · Dimensions (mm)	115 x 195 x 15 mm
Farbe · Colour	→ siehe Seite see page 229
Oberfläche · Finish	matt
Erzeugnisgruppe	Feinsteinzeug glasiert
Material	Glazed porcelain stoneware
Maßeinheit · Unit of measure	pce 0,96 kg 1 pce
Pro Paket · Per box	-
Pro Palette · Per pallet	-
Mindestabgabereinheit · Min. sales unit	E (pce)
Berechnungseinheit · Calculation unit	Stück · piece
Preisgruppe · Price group	E97



12 x 12 cm







Artikelnummer · Article number	3018
Warengruppe · Product group	Innenecke · Inside corner
Werksmaße · Dimensions (mm)	115 x 115 x 15 mm
Farbe · Colour	→ siehe Seite see page 229
Oberfläche · Finish	matt
Erzeugnisgruppe	Feinsteinzeug glasiert
Material	Glazed porcelain stoneware
Maßeinheit · Unit of measure	pce 1 kg 1 pce
Pro Paket · Per box	-
Pro Palette · Per pallet	-
Mindestabgabereinheit · Min. sales unit	E (pce)
Berechnungseinheit · Calculation unit	Stück · piece
Preisgruppe · Price group	E147

Auftragsbezogene Fertigung. Lieferzeit auf Anfrage.
Wegen der unterschiedlichen Produktionsverfahren von Fliesen und Formstücken können leichte Farbabweichungen auftreten.
Für Zuschnitte nach Zeichnung oder Angabe: 50% Mehrpreis.
Andere Farben aus dem Pro Architectura 3.0 Sortiment sind auf Anfrage und Abklärung der technischen Machbarkeit möglich und mit 30 % Mehrpreis lieferbar.

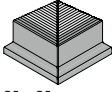
Custom-made production. Delivery time on request.
Due to different production methods used in manufacturing tiles and mouldings there is the possibility that slight colour variations may occur.
For customised cuts according to drawing or specifications: 50% surcharge.
After clarification of technical feasibility, other colours from the Pro Architectura 3.0 range are available on request for an extra charge of 30%.

PRO ARCHITECTURA 3.0 Pool System

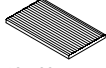
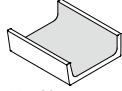
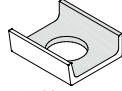
Finnisches Überflutungssystem / Wasserspiegel hochliegend Finnish overflow system / high-level system

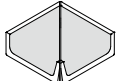
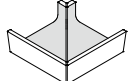
				
	20 x 20 cm	12 x 20 cm	12 x 12 cm	20 x 20 cm
Artikelnummer · Article number	3019	3050	3051	3052
Warengruppe · Product group	C304, C305, C306 C307	C304, C305, C306 C307	C304, C305, C306 C307	C304, C305, C306 C307
Werkmaße · Dimensions (mm)	Aussenecke · Outside corner 195 x 195 x 15 mm	Randplatte · End tile 115 x 195 x 10 mm	Innenecke · Inside corner 115 x 115 x 10 mm	Aussenecke · Outside corner 195 x 195 x 10 mm
Farbe · Colour	→ siehe Seite see page 229	→ siehe Seite see page 229	→ siehe Seite see page 229	→ siehe Seite see page 229
Oberfläche · Finish	matt	matt	matt	matt
Erzeugnisgruppe	Feinsteinzeug glasiert	Feinsteinzeug glasiert	Feinsteinzeug glasiert	Feinsteinzeug glasiert
Material	Glazed porcelain stoneware	Glazed porcelain stoneware	Glazed porcelain stoneware	Glazed porcelain stoneware
Maßeinheit · Unit of measure	pce 1,60 kg 1 pce	pce 0,33 kg 1 pce	pce 0,20 kg 1 pce	pce 0,46 kg 1 pce
Pro Paket · Per box	-	-	-	-
Pro Palette · Per pallet	-	-	-	-
Mindestabgabereinheit · Min. sales unit	E (pce)	E (pce)	E (pce)	E (pce)
Berechnungseinheit · Calculation unit	Stück · piece	Stück · piece	Stück · piece	Stück · piece
Preisgruppe · Price group	E147	E66	E129	E144
				
	6 x 20 cm	12 x 20 cm	17 x 20 cm	17 x 20 cm
Artikelnummer · Article number	3053	3054	3600	3601
Warengruppe · Product group	C300, C344, C349 C390	C300, C344	C300	C300
Werkmaße · Dimensions (mm)	Randplatte · End tile 56 x 195 x 10 mm	Rillenplatte · Grooved tile 115 x 195 x 10 mm	Rinnenschale · Overflow channel 170 x 197 x 65 mm	Ablauf · Outlet 170 x 197 x 65 mm
Farbe · Colour	-	-	neutral white	neutral white
Oberfläche · Finish	matt	matt	matt	matt
Erzeugnisgruppe	Feinsteinzeug glasiert	Feinsteinzeug glasiert	Feinsteinzeug glasiert	Feinsteinzeug glasiert
Material	Glazed porcelain stoneware	Glazed porcelain stoneware	Glazed porcelain stoneware	Glazed porcelain stoneware
Maßeinheit · Unit of measure	pce 0,20 kg 1 pce	pce 0,43 kg 1 pce	pce 1,84 kg 1 pce	pce 1,60 kg 1 pce
Pro Paket · Per box	-	-	-	-
Pro Palette · Per pallet	-	-	-	-
Mindestabgabereinheit · Min. sales unit	E (pce)	E (pce)	E (pce)	E (pce)
Berechnungseinheit · Calculation unit	Stück · piece	Stück · piece	Stück · piece	Stück · piece
Preisgruppe · Price group	E60	E60	E69	E108
				
	17 x 10 cm	17 x 17 cm	20 x 20 cm	
Artikelnummer · Article number	3602	3604	3605	
Warengruppe · Product group	C300	C300	C300	
Werkmaße · Dimensions (mm)	Rinnenschale · Overflow channel 170 x 97 x 65 mm	Innenecke · Inside corner 170 x 170 x 65 mm	Aussenecke · Outside corner 197 x 197 x 65 mm	
Farbe · Colour	neutral white	neutral white	neutral white	
Oberfläche · Finish	matt	matt	matt	
Erzeugnisgruppe	Feinsteinzeug glasiert	Feinsteinzeug glasiert	Feinsteinzeug glasiert	
Material	Glazed porcelain stoneware	Glazed porcelain stoneware	Glazed porcelain stoneware	
Maßeinheit · Unit of measure	pce 0,92 kg 1 pce	pce 1,20 kg 1 pce	pce 2,10 kg 1 pce	
Pro Paket · Per box	-	-	-	
Pro Palette · Per pallet	-	-	-	
Mindestabgabereinheit · Min. sales unit	E (pce)	E (pce)	E (pce)	
Berechnungseinheit · Calculation unit	Stück · piece	Stück · piece	Stück · piece	
Preisgruppe · Price group	E50	E108	E108	

Auftragsbezogene Fertigung. Lieferzeit auf Anfrage.
 Wegen der unterschiedlichen Produktionsverfahren von Fliesen und Formstücken können leichte Farbabweichungen auftreten.
 Für Zuschnitte nach Zeichnung oder Angabe: 50% Mehrpreis.
 Andere Farben aus dem Pro Architectura Sortiment sind auf Anfrage und Abklärung der technischen Machbarkeit möglich und mit 30 % Mehrpreis lieferbar.

Custom-made production. Delivery time on request.
 Due to different production methods used in manufacturing tiles and mouldings there is the possibility that slight colour variations may occur.
 For customised cuts according to drawing or specifications: 50% surcharge.
 After clarification of technical feasibility, other colours from the Pro Architectura range are available on request for an extra charge of 30%.

PRO ARCHITECTURA 3.0 Pool System

Architektur Design (System) · Architecture Design (System)

Steigleiter Pool edge

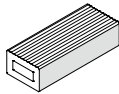

8 x 20 cm

Artikelnummer · Article number	3055
Warengruppe · Product group	C300, C344
Werksmaße · Dimensions (mm)	Steigleiter · Pool ladder
Farbe · Colour	80 x 195 x 50 mm
Oberfläche · Finish	-
Erzeugnisgruppe	matt
Material	Feinsteinzeug glasiert
Maßeinheit · Unit of measure	Glazed porcelain stoneware
Pro Paket · Per box	pce 1,25 kg 1 pce
Pro Palette · Per pallet	-
Mindestabgabereinheit · Min. sales unit	-
Berechnungseinheit · Calculation unit	E (pce)
Preisgruppe · Price group	Stück · piece
	E118

Große Rinne „Wiesbaden“ / Wasserspiegel hochliegend „Wiesbaden“ large overflow channel / high-level system

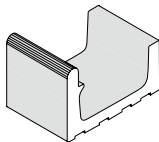

30 x 20 cm

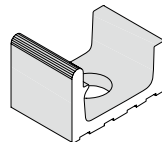

30 x 20 cm

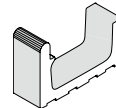

30 x 10 cm

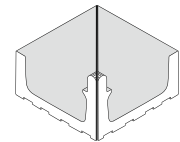

30 x 30 cm

Artikelnummer · Article number	3690	3691	3692	3694
Warengruppe · Product group	C300, C344, C349	C300, C344, C349	C300, C344, C349	C300, C344, C349
Werksmaße · Dimensions (mm)	C390	C390	C390	C390
Farbe · Colour	Rinnstein · Channel piece	Ablauf · Outlet	Rinnstein · Channel piece	Innenecke · Inside corner
Oberfläche · Finish	300 x 195 x 200 mm	300 x 195 x 200 mm	300 x 95 x 200 mm	300 x 300 x 200 mm
Erzeugnisgruppe	-	-	-	-
Material	matt	matt	matt	matt
Maßeinheit · Unit of measure	Feinsteinzeug glasiert	Feinsteinzeug glasiert	Feinsteinzeug glasiert	Feinsteinzeug glasiert
Pro Paket · Per box	Glazed porcelain stoneware	Glazed porcelain stoneware	Glazed porcelain stoneware	Glazed porcelain stoneware
Pro Palette · Per pallet	pce 9,60 kg 1 pce	pce 9,44 kg 1 pce	pce 4,80 kg 1 pce	pce 9,50 kg 1 pce
Mindestabgabereinheit · Min. sales unit	-	-	-	-
Berechnungseinheit · Calculation unit	E (pce)	E (pce)	E (pce)	E (pce)
Preisgruppe · Price group	Stück · piece	Stück · piece	Stück · piece	Stück · piece
	E131	E148	E119	E176

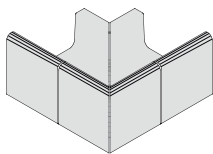

40 x 40 cm

Artikelnummer · Article number	3695
Warengruppe · Product group	C300, C344, C349
Werksmaße · Dimensions (mm)	C390
Farbe · Colour	Aussenecke · Outside corner
Oberfläche · Finish	395 x 395 x 200 mm
Erzeugnisgruppe	-
Material	matt
Maßeinheit · Unit of measure	Feinsteinzeug glasiert
Pro Paket · Per box	Glazed porcelain stoneware
Pro Palette · Per pallet	pce 25,50 kg 1 pce
Mindestabgabereinheit · Min. sales unit	-
Berechnungseinheit · Calculation unit	-
Preisgruppe · Price group	E (pce)
	Stück · piece
	E177

Autragsbezogene Fertigung. Lieferzeit auf Anfrage.
Wegen der unterschiedlichen Produktionsverfahren von Fliesen und Formstücken können leichte Farbabweichungen auftreten.
Für Zuschnitte nach Zeichnung oder Angabe: 50% Mehrpreis.
Andere Farben aus dem Pro Architectura 3.0 Sortiment sind auf Anfrage und Abklärung der technischen Machbarkeit möglich und mit 30% Mehrpreis lieferbar.

Custom-made production. Delivery time on request.
Due to different production methods used in manufacturing tiles and mouldings there is the possibility that slight colour variations may occur.
For customised cuts according to drawing or specifications: 50% surcharge.
After clarification of technical feasibility, other colours from the Pro Architectura 3.0 range are available on request for an extra charge of 30%.

PRO ARCHITECTURA 3.0 Pool System

Große Rinne „Wiesbaden“ mit Mosaikausklinkung / Wasserspiegel hochliegend „Wiesbaden“ large overflow channel with mosaic recess / high-level system

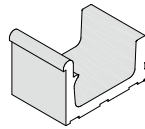

30 x 20 cm

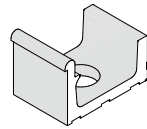

30 x 20 cm

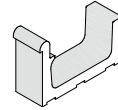

30 x 10 cm

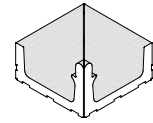

30 x 30 cm

Artikelnummer · Article number	3680	3681	3682	3684
C300, C344, C349	✳️◆	✳️◆	✳️◆	✳️◆
C390	✳️◆	✳️◆	✳️◆	✳️◆
Warengruppe · Product group	Rinnstein · Channel piece	Ablauf · Outlet	Rinnstein · Channel piece	Innenecke · Inside corner
Werkmaße · Dimensions (mm)	300 x 195 x 200 mm	300 x 195 x 200 mm	300 x 95 x 200 mm	300 x 300 x 200 mm
Farbe · Colour	-	-	-	-
Oberfläche · Finish	matt	matt	matt	matt
Erzeugnisgruppe	Feinsteinzeug glasiert	Feinsteinzeug glasiert	Feinsteinzeug glasiert	Feinsteinzeug glasiert
Material	Glazed porcelain stoneware	Glazed porcelain stoneware	Glazed porcelain stoneware	Glazed porcelain stoneware
Maßeinheit · Unit of measure	pce 9,40 kg 1 pce	pce 9,25 kg 1 pce	pce 4,60 kg 1 pce	pce 9,50 kg 1 pce
Pro Paket · Per box	-	-	-	-
Pro Palette · Per pallet	-	-	-	-
Mindestabgabereinheit · Min. sales unit	E (pce)	E (pce)	E (pce)	E (pce)
Berechnungseinheit · Calculation unit	Stück · piece	Stück · piece	Stück · piece	Stück · piece
Preisgruppe · Price group	E130	E144	E115	E176

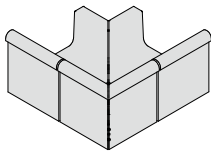

40 x 40 cm

Artikelnummer · Article number	3685
C300, C344, C349	✳️◆
C390	✳️◆
Warengruppe · Product group	Aussenecke · Outside corner
Werkmaße · Dimensions (mm)	395 x 395 x 200 mm
Farbe · Colour	-
Oberfläche · Finish	matt
Erzeugnisgruppe	Feinsteinzeug glasiert
Material	Glazed porcelain stoneware
Maßeinheit · Unit of measure	pce 24,90 kg 1 pce
Pro Paket · Per box	-
Pro Palette · Per pallet	-
Mindestabgabereinheit · Min. sales unit	E (pce)
Berechnungseinheit · Calculation unit	Stück · piece
Preisgruppe · Price group	E171

Autragsbezogene Fertigung. Lieferzeit auf Anfrage.
 Wegen der unterschiedlichen Produktionsverfahren von Fliesen und Formstücken können leichte Farbabweichungen auftreten.
 Für Zuschnitte nach Zeichnung oder Angabe: 50% Mehrpreis.
 Andere Farben aus dem Pro Architectura Sortiment sind auf Anfrage und Abklärung der technischen Machbarkeit möglich und mit 30 % Mehrpreis lieferbar.

Custom-made production. Delivery time on request.
 Due to different production methods used in manufacturing tiles and mouldings there is the possibility that slight colour variations may occur.
 For customised cuts according to drawing or specifications: 50% surcharge.
 After clarification of technical feasibility, other colours from the Pro Architectura range are available on request for an extra charge of 30%.

PRO ARCHITECTURA 3.0 Pool System

Architektur Design (System) · Architecture Design (System)

Kleine Rinne „Wiesbaden“ / Wasserspiegel hochliegend „Wiesbaden“ small overflow channel / high-level system

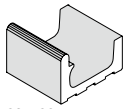

23 x 20 cm

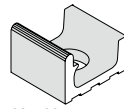

23 x 20 cm

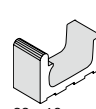

23 x 10 cm

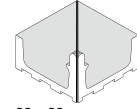

23 x 23 cm

Artikelnummer · Article number	3670	3671	3672	3674
C300, C344, C349 C390	✱ ◆ ✱ ◆	C300, C344, C349 C390	✱ ◆ ✱ ◆	C300, C344, C349 C390
Warengruppe · Product group	Rinnstein · Channel piece	Ablauf · Outlet	Rinnstein · Channel piece	Innenecke · Inside corner
Werksmaße · Dimensions (mm)	225 x 195 x 150 mm	225 x 195 x 150 mm	225 x 95 x 150 mm	225 x 225 x 150 mm
Farbe · Colour	-	-	-	-
Oberfläche · Finish	matt	matt	matt	matt
Erzeugnisgruppe	Feinsteinzeug glasiert	Feinsteinzeug glasiert	Feinsteinzeug glasiert	Feinsteinzeug glasiert
Material	Glazed porcelain stoneware	Glazed porcelain stoneware	Glazed porcelain stoneware	Glazed porcelain stoneware
Maßeinheit · Unit of measure	pce 7,20 kg 1 pce	pce 6,72 kg 1 pce	pce 3,60 kg 1 pce	pce 7 kg 1 pce
Pro Paket · Per box	-	-	-	-
Pro Palette · Per pallet	-	-	-	-
Mindestabgabereinheit · Min. sales unit	E (pce)	E (pce)	E (pce)	E (pce)
Berechnungseinheit · Calculation unit	Stück · piece	Stück · piece	Stück · piece	Stück · piece
Preisgruppe · Price group	E118	E137	E105	E163

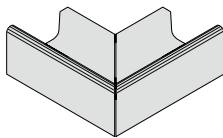

40 x 40 cm

Artikelnummer · Article number	3675
C300, C344, C349 C390	✱ ◆ ✱ ◆
Warengruppe · Product group	Aussenecke · Outside corner
Werksmaße · Dimensions (mm)	395 x 395 x 150 mm
Farbe · Colour	-
Oberfläche · Finish	matt
Erzeugnisgruppe	Feinsteinzeug glasiert
Material	Glazed porcelain stoneware
Maßeinheit · Unit of measure	pce 7,64 kg 1 pce
Pro Paket · Per box	-
Pro Palette · Per pallet	-
Mindestabgabereinheit · Min. sales unit	E (pce)
Berechnungseinheit · Calculation unit	Stück · piece
Preisgruppe · Price group	E172

Autragsbezogene Fertigung. Lieferzeit auf Anfrage.
Wegen der unterschiedlichen Produktionsverfahren von Fliesen und Formstücken können leichte Farbabweichungen auftreten.
Für Zuschnitte nach Zeichnung oder Angabe: 50% Mehrpreis.
Andere Farben aus dem Pro Architectura Sortiment sind auf Anfrage und Abklärung der technischen Machbarkeit möglich und mit 30 % Mehrpreis lieferbar.

Custom-made production. Delivery time on request.
Due to different production methods used in manufacturing tiles and mouldings there is the possibility that slight colour variations may occur.
For customised cuts according to drawing or specifications: 50% surcharge.
After clarification of technical feasibility, other colours from the Pro Architectura range are available on request for an extra charge of 30%.

PRO ARCHITECTURA 3.0 Pool System

„Berliner“ Rinne /Wasserspiegel hochliegend „Berliner“ overflow channel / high-level system



13 x 20 cm



13 x 10 cm



13 x 13 cm

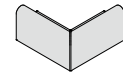

20 x 20 cm

Artikelnummer - Article number	3540	3542	3544	3545
C300, C344, C349 C390	✳️◆ ✳️◆	C300, C344, C349 C390	✳️◆ ✳️◆	C300, C344, C349 C390
Warengruppe - Product group	Randstein - Running edge	Randstein - Running edge	Innenecke - Inside corner	Aussenecke - Outside corner
Werkmaße - Dimensions (mm)	160 x 195 x 115 mm	160 x 95 x 115 mm	160 x 160 x 115 mm	195 x 195 x 115 mm
Farbe - Colour	-	-	-	-
Oberfläche - Finish	matt	matt	matt	matt
Erzeugnisgruppe	Feinsteinzeug glasiert	Feinsteinzeug glasiert	Feinsteinzeug glasiert	Feinsteinzeug glasiert
Material	Glazed porcelain stoneware	Glazed porcelain stoneware	Glazed porcelain stoneware	Glazed porcelain stoneware
Maßeinheit - Unit of measure	pce 5,60 kg 1 pce	pce 2,80 kg 1 pce	pce 5,20 kg 1 pce	pce 9,60 kg 1 pce
Pro Paket - Per box	-	-	-	-
Pro Palette - Per pallet	-	-	-	-
Mindestabgabereinheit - Min. sales unit	E (pce)	E (pce)	E (pce)	E (pce)
Berechnungseinheit - Calculation unit	Stück - piece	Stück - piece	Stück - piece	Stück - piece
Preisgruppe - Price group	E123	E115	E144	E170

Große Rinne „Wiesbaden“ / Wasserspiegel tiefliegend „Wiesbaden“ large overflow channel / low-level system

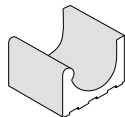

23 x 20 cm

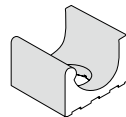

23 x 20 cm

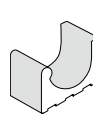

23 x 10 cm

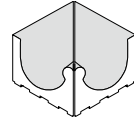

23 x 23 cm

Artikelnummer - Article number	3630	3631	3632	3634
C300, C344, C349 C390	✳️◆ ✳️◆	C300, C344, C349 C390	✳️◆ ✳️◆	C300, C344, C349 C390
Warengruppe - Product group	Rinnstein - Channel piece	Ablauf - Outlet	Rinnstein - Channel piece	Rinnstein - Channel piece
Werkmaße - Dimensions (mm)	215 x 195 x 140 mm	215 x 195 x 140 mm	215 x 95 x 140 mm	215 x 215 x 140 mm
Farbe - Colour	-	-	-	-
Oberfläche - Finish	matt	matt	matt	matt
Erzeugnisgruppe	Feinsteinzeug glasiert	Feinsteinzeug glasiert	Feinsteinzeug glasiert	Feinsteinzeug glasiert
Material	Glazed porcelain stoneware	Glazed porcelain stoneware	Glazed porcelain stoneware	Glazed porcelain stoneware
Maßeinheit - Unit of measure	pce 6,50 kg 1 pce	pce 6,65 kg 1 pce	pce 3,45 kg 1 pce	pce 7 kg 1 pce
Pro Paket - Per box	-	-	-	-
Pro Palette - Per pallet	-	-	-	-
Mindestabgabereinheit - Min. sales unit	E (pce)	E (pce)	E (pce)	E (pce)
Berechnungseinheit - Calculation unit	Stück - piece	Stück - piece	Stück - piece	Stück - piece
Preisgruppe - Price group	E117	E142	E101	E161



40 x 40 cm

Artikelnummer - Article number	3635
C300, C344, C349 C390	✳️◆ ✳️◆
Warengruppe - Product group	Aussenecke - Outside corner
Werkmaße - Dimensions (mm)	395 x 395 x 140 mm
Farbe - Colour	-
Oberfläche - Finish	matt
Erzeugnisgruppe	Feinsteinzeug glasiert
Material	Glazed porcelain stoneware
Maßeinheit - Unit of measure	pce 7 kg 1 pce
Pro Paket - Per box	-
Pro Palette - Per pallet	-
Mindestabgabereinheit - Min. sales unit	E (pce)
Berechnungseinheit - Calculation unit	Stück - piece
Preisgruppe - Price group	E173

Autragsbezogene Fertigung. Lieferzeit auf Anfrage.
Wegen der unterschiedlichen Produktionsverfahren von Fliesen und Formstücken können leichte Farbabweichungen auftreten.
Für Zuschnitte nach Zeichnung oder Angabe: 50% Mehrpreis.
Andere Farben aus dem Pro Architectura 3.0 Sortiment sind auf Anfrage und Abklärung der technischen Machbarkeit möglich und mit 30% Mehrpreis lieferbar.

Custom-made production. Delivery time on request.
Due to different production methods used in manufacturing tiles and mouldings there is the possibility that slight colour variations may occur.
For customised cuts according to drawing or specifications: 50% surcharge.
After clarification of technical feasibility, other colours from the Pro Architectura 3.0 range are available on request for an extra charge of 30%.

PRO ARCHITECTURA 3.0 Pool System

Architektur Design (System) · Architecture Design (System)

Kleine Rinne „Wiesbaden“ / Wasserspiegel tieflegend „Wiesbaden“ small overflow channel / low-level system

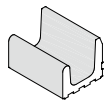

15 x 20 cm

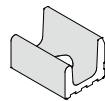

15 x 20 cm

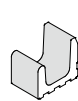

15 x 10 cm

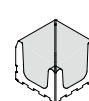

15 x 15 cm

Artikelnummer · Article number	3660	3661	3662	3664
C300, C344, C349	✳️◆	✳️◆	✳️◆	✳️◆
C390	✳️◆	✳️◆	✳️◆	✳️◆
Warengruppe · Product group	Rinnstein · Channel piece	Ablauf · Outlet	Rinnstein · Channel piece	Innenecke · Inside corner
Werkmaße · Dimensions (mm)	150 x 195 x 100 mm	150 x 195 x 100 mm	150 x 95 x 100 mm	150 x 150 x 100 mm
Farbe · Colour	-	-	-	-
Oberfläche · Finish	matt	matt	matt	matt
Erzeugnisgruppe	Feinsteinzeug glasiert	Feinsteinzeug glasiert	Feinsteinzeug glasiert	Feinsteinzeug glasiert
Material	Glazed porcelain stoneware	Glazed porcelain stoneware	Glazed porcelain stoneware	Glazed porcelain stoneware
Maßeinheit · Unit of measure	pce 3,28 kg 1 pce	pce 2,96 kg 1 pce	pce 1,64 kg 1 pce	pce 2,60 kg 1 pce
Pro Paket · Per box	-	-	-	-
Pro Palette · Per pallet	-	-	-	-
Mindestabgabereinheit · Min. sales unit	E (pce)	E (pce)	E (pce)	E (pce)
Berechnungseinheit · Calculation unit	Stück · piece	Stück · piece	Stück · piece	Stück · piece
Preisgruppe · Price group	E113	E133	E97	E157

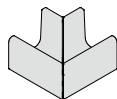

20 x 20 cm

Artikelnummer · Article number	3665
C300, C344, C349	✳️◆
C390	✳️◆
Warengruppe · Product group	Aussenecke · Outside corner
Werkmaße · Dimensions (mm)	195 x 195 x 100 mm
Farbe · Colour	-
Oberfläche · Finish	matt
Erzeugnisgruppe	Feinsteinzeug glasiert
Material	Glazed porcelain stoneware
Maßeinheit · Unit of measure	pce 3,96 kg 1 pce
Pro Paket · Per box	-
Pro Palette · Per pallet	-
Mindestabgabereinheit · Min. sales unit	E (pce)
Berechnungseinheit · Calculation unit	Stück · piece
Preisgruppe · Price group	E161

Autragsbezogene Fertigung. Lieferzeit auf Anfrage.
Wegen der unterschiedlichen Produktionsverfahren von Fliesen und Formstücken können leichte Farbabweichungen auftreten.
Für Zuschnitte nach Zeichnung oder Angabe: 50% Mehrpreis.
Andere Farben aus dem Pro Architectura 3.0 Sortiment sind auf Anfrage und Abklärung der technischen Machbarkeit möglich und mit 30 % Mehrpreis lieferbar.

Custom-made production. Delivery time on request.
Due to different production methods used in manufacturing tiles and mouldings there is the possibility that slight colour variations may occur.
For customised cuts according to drawing or specifications: 50% surcharge.
After clarification of technical feasibility, other colours from the Pro Architectura 3.0 range are available on request for an extra charge of 30%.

Beckenrandstein / Wasserspiegel tieflegend Pool running edge / low-level system

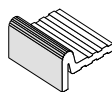

18 x 20 cm



18 x 10 cm

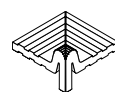

18 x 18 cm

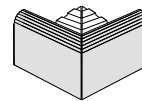

20 x 20 cm

Artikelnummer · Article number	3650	3652	3654	3655
C300, C344, C349	✳️◆	✳️◆	✳️◆	✳️◆
C390	✳️◆	✳️◆	✳️◆	✳️◆
Warengruppe · Product group	Randstein · Running edge	Randstein · Running edge	Innenecke · Inside corner	Aussenecke · Outside corner
Werkmaße · Dimensions (mm)	180 x 195 x 115 mm	180 x 95 x 115 mm	180 x 180 x 115 mm	195 x 195 x 115 mm
Farbe · Colour	-	-	-	-
Oberfläche · Finish	matt	matt	matt	matt
Erzeugnisgruppe	Feinsteinzeug glasiert	Feinsteinzeug glasiert	Feinsteinzeug glasiert	Feinsteinzeug glasiert
Material	Glazed porcelain stoneware	Glazed porcelain stoneware	Glazed porcelain stoneware	Glazed porcelain stoneware
Maßeinheit · Unit of measure	pce 2,64 kg 1 pce	pce 1,32 kg 1 pce	pce 1,70 kg 1 pce	pce 4,08 kg 1 pce
Pro Paket · Per box	-	-	-	-
Pro Palette · Per pallet	-	-	-	-
Mindestabgabereinheit · Min. sales unit	E (pce)	E (pce)	E (pce)	E (pce)
Berechnungseinheit · Calculation unit	Stück · piece	Stück · piece	Stück · piece	Stück · piece
Preisgruppe · Price group	E121	E105	E142	E163

PRO ARCHITECTURA 3.0 Pool System

Zubehör Accessories



6 x 9 cm



6 x 5 cm



10 x 14 cm



4 x 10 cm

Artikelnummer · Article number	3962	3963	3972	3952
C901	C901	C904	C902	C903
Warengruppe · Product group	Flüsterablauf · Whispering drain	Ablauf · Outlet	Flüsterablauf · Whispering drain	Ablaufstutzen · Drain connector
Werkgröße · Dimensions (mm)	62 x 88 x 48 mm	62 x 53 x 48 mm	105 x 138 x 75 mm	35 x 110 x 7 mm
Farbe · Colour	grau · grey	grau · grey	grau · grey	gelb · yellow
Oberfläche · Finish	matt	matt	matt	matt
Erzeugnisgruppe	Kunststoff	Kunststoff	Kunststoff	Kunststoff
Material	Plastic	Plastic	Plastic	Plastic
Maßeinheit · Unit of measure	pce 0,11 kg 1 pce	pce 0,11 kg 1 pce	pce 0,13 kg 1 pce	pce 0,05 kg 1 pce
Pro Paket · Per box	-	-	-	-
Pro Palette · Per pallet	-	-	-	-
Mindestabgabereinheit · Min. sales unit	E (pce)	E (pce)	E (pce)	E (pce)
Berechnungseinheit · Calculation unit	Stück · piece	Stück · piece	Stück · piece	Stück · piece
Preisgruppe · Price group	E152	E152	E152	E69

Keramische Rinne im Beckenumgang Ceramic channel in the pool rim

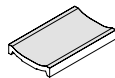

15 x 20 cm

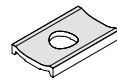

15 x 20 cm



15 x 10 cm



15 x 15 cm

Artikelnummer · Article number	3620	3621	3622	3624
C300, C311, C360 C390	C300, C311, C360 C390	C300, C311, C360 C390	C300, C311, C360 C390	C300, C311, C360 C390
Warengruppe · Product group	Rinnenschale · Overflow channel	Rinnenschale · Overflow channel	Rinnenschale · Overflow channel	Innenecke · Inside corner
Werkgröße · Dimensions (mm)	150 x 197 x 35 mm	150 x 197 x 35 mm	150 x 97 x 35 mm	150 x 150 x 35 mm
Farbe · Colour	-	-	-	-
Oberfläche · Finish	matt	matt	matt	matt
Erzeugnisgruppe	Feinsteinzeug glasiert	Feinsteinzeug glasiert	Feinsteinzeug glasiert	Feinsteinzeug glasiert
Material	Glazed porcelain stoneware	Glazed porcelain stoneware	Glazed porcelain stoneware	Glazed porcelain stoneware
Maßeinheit · Unit of measure	pce 1,28 kg 1 pce	pce 1,12 kg 1 pce	pce 0,64 kg 1 pce	pce 0,72 kg 1 pce
Pro Paket · Per box	-	-	-	-
Pro Palette · Per pallet	-	-	-	-
Mindestabgabereinheit · Min. sales unit	E (pce)	E (pce)	E (pce)	E (pce)
Berechnungseinheit · Calculation unit	Stück · piece	Stück · piece	Stück · piece	Stück · piece
Preisgruppe · Price group	E50	E108	E41	E115

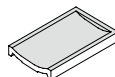

15 x 20 cm

Artikelnummer · Article number	3626
C300, C311, C360 C390	C300, C311, C360 C390
Warengruppe · Product group	Randfliese · Bullnose
Werkgröße · Dimensions (mm)	150 x 197 x 35 mm
Farbe · Colour	-
Oberfläche · Finish	matt
Erzeugnisgruppe	Feinsteinzeug glasiert
Material	Glazed porcelain stoneware
Maßeinheit · Unit of measure	pce 1,36 kg 1 pce
Pro Paket · Per box	-
Pro Palette · Per pallet	-
Mindestabgabereinheit · Min. sales unit	E (pce)
Berechnungseinheit · Calculation unit	Stück · piece
Preisgruppe · Price group	E97













Autragsbezogene Fertigung. Lieferzeit auf Anfrage.
Wegen der unterschiedlichen Produktionsverfahren von Fliesen und Formstücken können leichte Farbabweichungen auftreten.
Für Zuschnitte nach Zeichnung oder Angabe: 50% Mehrpreis.
Andere Farben aus dem Pro Architectura 3.0 Sortiment sind auf Anfrage und Abklärung der technischen Machbarkeit möglich und mit 30% Mehrpreis lieferbar.

Custom-made production. Delivery time on request.
Due to different production methods used in manufacturing tiles and mouldings there is the possibility that slight colour variations may occur.
For customised cuts according to drawing or specifications: 50% surcharge.
After clarification of technical feasibility, other colours from the Pro Architectura 3.0 range are available on request for an extra charge of 30%.

PRO ARCHITECTURA 3.0 Pool System

Architektur Design (System) · Architecture Design (System)

Radial- & Hohlkehlleisten Curved and cove base ceramic beading

	 4 x 20 cm	 4 x 10 cm	 7 x 7 cm	 4 x 4 cm
Artikelnummer · Article number	3121	3122	3123	3124
C300, C311, C360	✳️◆	✳️◆	✳️◆	✳️◆
C390	✳️◆	✳️◆	✳️◆	✳️◆
Warengruppe · Product group	Radialleiste · Curved ceramic beading	Radialleiste · Curved ceramic beading	Aussenecke · Outside corner	Aussenecke · Outside corner
Werkgröße · Dimensions (mm)	40 x 197 x 8 mm	40 x 97 x 8 mm	70 x 70 x 8 mm	40 x 40 x 8 mm
Farbe · Colour	-	-	-	-
Oberfläche · Finish	matt	matt	matt	matt
Erzeugnisgruppe	Feinsteinzeug glasiert	Feinsteinzeug glasiert	Feinsteinzeug glasiert	Feinsteinzeug glasiert
Material	Glazed porcelain stoneware	Glazed porcelain stoneware	Glazed porcelain stoneware	Glazed porcelain stoneware
Maßeinheit · Unit of measure	pce 0,24 kg 1 pce	pce 0,12 kg 1 pce	pce 0,15 kg 1 pce	pce 0,09 kg 1 pce
Pro Paket · Per box	-	-	-	-
Pro Palette · Per pallet	-	-	-	-
Mindestabgabeneinheit · Min. sales unit	E (pce)	E (pce)	E (pce)	E (pce)
Berechnungseinheit · Calculation unit	Stück · piece	Stück · piece	Stück · piece	Stück · piece
Preisgruppe · Price group	E22	E20	E69	E48
	 7 x 7 cm	 4 x 20 cm	 4 x 4 cm	 6 x 20 cm
Artikelnummer · Article number	3125	3120	3126	3161
C300, C311, C360	✳️◆	✳️◆	✳️◆	✳️◆
C390	✳️◆	✳️◆	✳️◆	✳️◆
Warengruppe · Product group	Innenecke · Inside corner	Hohlkehlleiste · Cove base ceramic beading	Innenecke · Inside corner	Radialleiste · Curved ceramic beading
Werkgröße · Dimensions (mm)	70 x 70 x 8 mm	40 x 197 x 8 mm	40 x 40 x 8 mm	60 x 197 x 8 mm
Farbe · Colour	-	-	-	-
Oberfläche · Finish	matt	matt	matt	matt
Erzeugnisgruppe	Feinsteinzeug glasiert	Feinsteinzeug glasiert	Feinsteinzeug glasiert	Feinsteinzeug glasiert
Material	Glazed porcelain stoneware	Glazed porcelain stoneware	Glazed porcelain stoneware	Glazed porcelain stoneware
Maßeinheit · Unit of measure	pce 0,07 kg 1 pce	pce 0,29 kg 1 pce	pce 0,05 kg 1 pce	pce 0,32 kg 1 pce
Pro Paket · Per box	-	-	-	-
Pro Palette · Per pallet	-	-	-	-
Mindestabgabeneinheit · Min. sales unit	E (pce)	E (pce)	E (pce)	E (pce)
Berechnungseinheit · Calculation unit	Stück · piece	Stück · piece	Stück · piece	Stück · piece
Preisgruppe · Price group	E85	E24	E38	E38
	 6 x 10 cm	 6 x 6 cm	 9 x 9 cm	 9 x 9 cm
Artikelnummer · Article number	3162	3164	3165	3163
C300, C311, C360	✳️◆	✳️◆	✳️◆	✳️◆
C390	✳️◆	✳️◆	✳️◆	✳️◆
Warengruppe · Product group	Radialleiste · Curved ceramic beading	Aussenecke · Outside corner	Innenecke · Inside corner	Aussenecke · Outside corner
Werkgröße · Dimensions (mm)	60 x 97 x 8 mm	60 x 60 x 8 mm	90 x 90 x 8 mm	90 x 90 x 8 mm
Farbe · Colour	-	-	-	-
Oberfläche · Finish	matt	matt	matt	matt
Erzeugnisgruppe	Feinsteinzeug glasiert	Feinsteinzeug glasiert	Feinsteinzeug glasiert	Feinsteinzeug glasiert
Material	Glazed porcelain stoneware	Glazed porcelain stoneware	Glazed porcelain stoneware	Glazed porcelain stoneware
Maßeinheit · Unit of measure	pce 0,16 kg 1 pce	pce 0,10 kg 1 pce	pce 0,10 kg 1 pce	pce 0,10 kg 1 pce
Pro Paket · Per box	-	-	-	-
Pro Palette · Per pallet	-	-	-	-
Mindestabgabeneinheit · Min. sales unit	E (pce)	E (pce)	E (pce)	E (pce)
Berechnungseinheit · Calculation unit	Stück · piece	Stück · piece	Stück · piece	Stück · piece
Preisgruppe · Price group	E38	E78	E95	E88

Autragsbezogene Fertigung. Lieferzeit auf Anfrage.
 Wegen der unterschiedlichen Produktionsverfahren von Fliesen und Formstücken können leichte Farbabweichungen auftreten.
 Für Zuschnitte nach Zeichnung oder Angabe: 50% Mehrpreis.
 Andere Farben aus dem Pro Architectura Sortiment sind auf Anfrage und Abklärung der technischen Machbarkeit möglich und mit 30 % Mehrpreis lieferbar.
 Custom-made production. Delivery time on request.
 Due to different production methods used in manufacturing tiles and mouldings there is the possibility that slight colour variations may occur.
 For customised cuts according to drawing or specifications: 50% surcharge.
 After clarification of technical feasibility, other colours from the Pro Architectura range are available on request for an extra charge of 30%.

PRO ARCHITECTURA 3.0 Pool System

Schriftplatte Lettering tile



12 x 20 cm

3056

C3MD

Schriftplatte · Lettering tile

115 x 195 x 15 mm

weiß · white

matt

Feinsteinzeug glasiert

Glazed porcelain stoneware

pce | 0,48 kg | 1 pce

-

-

E (pce)

Stück · piece

-

Auftragsbezogene Fertigung. Preis auf Anfrage.
Custom-made production. Price on request.



12 x 20 cm

3056

C3WS

Schriftplatte · Lettering tile

115 x 195 x 15 mm

weiß · white

matt

Feinsteinzeug glasiert

Glazed porcelain stoneware

pce | 0,48 kg | 1 pce

-

-

E (pce)

Stück · piece

-

Auftragsbezogene Fertigung. Preis auf Anfrage.
Custom-made production. Price on request.

Farbkombinationen · Colour combinations

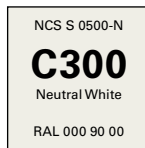

C300 Neutral White
+
C349 Ultramarine Blue

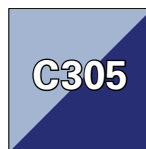

C344 Icy Blue
+
C349 Ultramarine Blue



C300 Neutral White
+
C390 Solid Grey

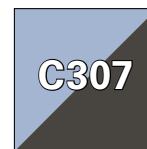

C344 Icy Blue
+
C390 Solid Grey

PURE LINE 2.0 Architektur Design (System) · Architecture Design (System)



120 x 120 cm

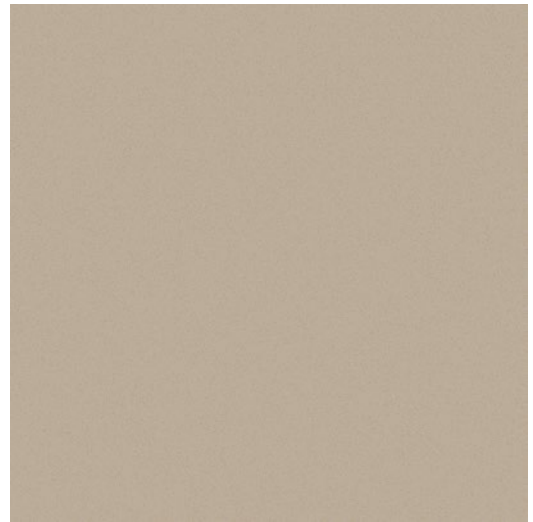

120 x 120 cm



Artikelnummer · Article number	2750
Warengruppe · Product group	Grundfliese · Basic tile
Werksmaße · Dimensions (mm)	1195 x 1195 x 12 mm
Farbe · Colour	ivory
Oberfläche · Finish	matt Keramikstruktur reliefiert · matt ceramic texture relief
Erzeugnisgruppe	VilbostonePlus
Material	Feinsteinzeug
Maßeinheit · Unit of measure	Porcelain stoneware
Pro Paket · Per box	m ² 27,99 kg 0,69 pce
Pro Palette · Per pallet	1,44 m ² 40,30 kg 1 pce
Mindestabgabereinheit · Min. sales unit	34,56 m ² 967,20 kg 24 box
Berechnungseinheit · Calculation unit	P (box)
Preisgruppe · Price group	m ²

Artikelnummer · Article number	2750
Warengruppe · Product group	Grundfliese · Basic tile
Werksmaße · Dimensions (mm)	1195 x 1195 x 12 mm
Farbe · Colour	sand beige
Oberfläche · Finish	matt Keramikstruktur reliefiert · matt ceramic texture relief
Erzeugnisgruppe	VilbostonePlus
Material	Feinsteinzeug
Maßeinheit · Unit of measure	Porcelain stoneware
Pro Paket · Per box	m ² 27,99 kg 0,69 pce
Pro Palette · Per pallet	1,44 m ² 40,30 kg 1 pce
Mindestabgabereinheit · Min. sales unit	34,56 m ² 967,20 kg 24 box
Berechnungseinheit · Calculation unit	P (box)
Preisgruppe · Price group	m ²

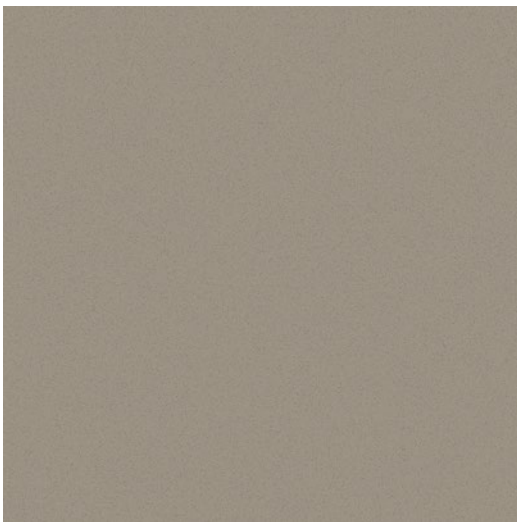

120 x 120 cm

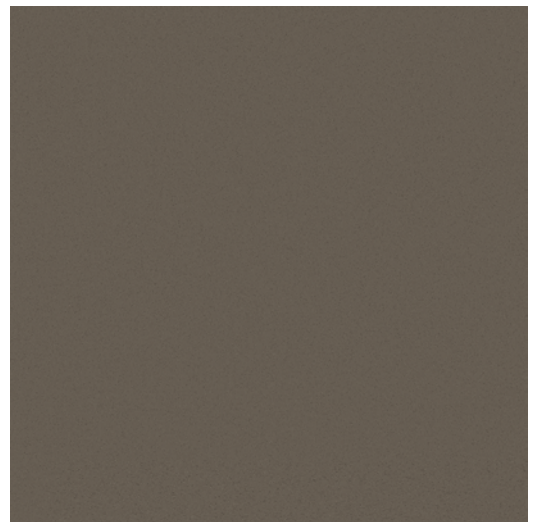

120 x 120 cm



Artikelnummer · Article number	2750
Warengruppe · Product group	Grundfliese · Basic tile
Werksmaße · Dimensions (mm)	1195 x 1195 x 12 mm
Farbe · Colour	clay brown
Oberfläche · Finish	matt Keramikstruktur reliefiert · matt ceramic texture relief
Erzeugnisgruppe	VilbostonePlus
Material	Feinsteinzeug
Maßeinheit · Unit of measure	Porcelain stoneware
Pro Paket · Per box	m ² 27,99 kg 0,69 pce
Pro Palette · Per pallet	1,44 m ² 40,30 kg 1 pce
Mindestabgabereinheit · Min. sales unit	34,56 m ² 967,20 kg 24 box
Berechnungseinheit · Calculation unit	P (box)
Preisgruppe · Price group	m ²

Artikelnummer · Article number	2750
Warengruppe · Product group	Grundfliese · Basic tile
Werksmaße · Dimensions (mm)	1195 x 1195 x 12 mm
Farbe · Colour	earth brown
Oberfläche · Finish	matt Keramikstruktur reliefiert · matt ceramic texture relief
Erzeugnisgruppe	VilbostonePlus
Material	Feinsteinzeug
Maßeinheit · Unit of measure	Porcelain stoneware
Pro Paket · Per box	m ² 27,99 kg 0,69 pce
Pro Palette · Per pallet	1,44 m ² 40,30 kg 1 pce
Mindestabgabereinheit · Min. sales unit	34,56 m ² 967,20 kg 24 box
Berechnungseinheit · Calculation unit	P (box)
Preisgruppe · Price group	m ²











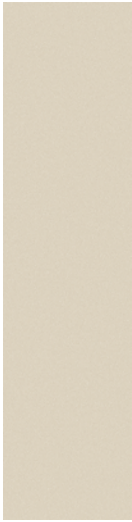

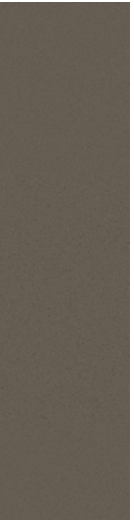















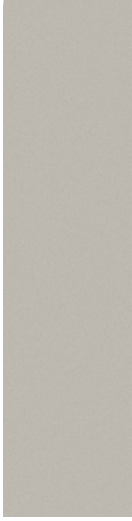

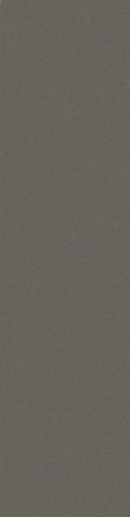
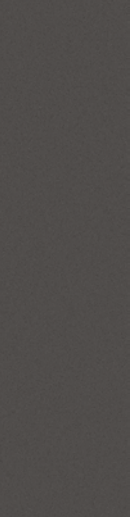





PURE LINE 2.0 Architektur Design (System) · Architecture Design (System)

	120 x 120 cm	120 x 120 cm
Artikelnummer · Article number	2750	2750
	UL60	UL61
Warengruppe · Product group	Grundfliese · Basic tile	Grundfliese · Basic tile
Werksmaße · Dimensions (mm)	1195 x 1195 x 12 mm	1195 x 1195 x 12 mm
Farbe · Colour	foggy grey	cement grey
Oberfläche · Finish	matt Keramikstruktur reliefiert · matt ceramic texture relief	matt Keramikstruktur reliefiert · matt ceramic texture relief
Erzeugnisgruppe	VilbostonePlus	VilbostonePlus
Material	Feinsteinzeug	Feinsteinzeug
Maßeinheit · Unit of measure	Porcelain stoneware	Porcelain stoneware
Pro Paket · Per box	m ² 27,99 kg 0,69 pce	m ² 27,99 kg 0,69 pce
Pro Palette · Per pallet	1,44 m ² 40,30 kg 1 pce	1,44 m ² 40,30 kg 1 pce
Mindestabgabereinheit · Min. sales unit	34,56 m ² 967,20 kg 24 box	34,56 m ² 967,20 kg 24 box
Berechnungseinheit · Calculation unit	P (box)	P (box)
Preisgruppe · Price group	m ²	m ²
	P152	P152
	120 x 120 cm	120 x 120 cm
Artikelnummer · Article number	2750	2750
	UL62	UL90
Warengruppe · Product group	Grundfliese · Basic tile	Grundfliese · Basic tile
Werksmaße · Dimensions (mm)	1195 x 1195 x 12 mm	1195 x 1195 x 12 mm
Farbe · Colour	concrete grey	asphalt grey
Oberfläche · Finish	matt Keramikstruktur reliefiert · matt ceramic texture relief	matt Keramikstruktur reliefiert · matt ceramic texture relief
Erzeugnisgruppe	VilbostonePlus	VilbostonePlus
Material	Feinsteinzeug	Feinsteinzeug
Maßeinheit · Unit of measure	Porcelain stoneware	Porcelain stoneware
Pro Paket · Per box	m ² 27,99 kg 0,69 pce	m ² 27,99 kg 0,69 pce
Pro Palette · Per pallet	1,44 m ² 40,30 kg 1 pce	1,44 m ² 40,30 kg 1 pce
Mindestabgabereinheit · Min. sales unit	34,56 m ² 967,20 kg 24 box	34,56 m ² 967,20 kg 24 box
Berechnungseinheit · Calculation unit	P (box)	P (box)
Preisgruppe · Price group	m ²	m ²
	P152	P152







PURE LINE 2.0 Architektur Design (System) · Architecture Design (System)

	60 x 120 cm	60 x 120 cm	60 x 120 cm	60 x 120 cm
Artikelnummer · Article number	2751	2751	2751	2751
Warengruppe · Product group	UL10	UL70	UL72	UL80
Werkmaße · Dimensions (mm)	Grundfliese · Basic tile	Grundfliese · Basic tile	Grundfliese · Basic tile	Grundfliese · Basic tile
Farbe · Colour	595 x 1195 x 12 mm	595 x 1195 x 12 mm	595 x 1195 x 12 mm	595 x 1195 x 12 mm
Oberfläche · Finish	ivory	sand beige	clay brown	earth brown
Erzeugnisgruppe	matt Keramikstruktur reliefiert · matt ceramic texture relief	matt Keramikstruktur reliefiert · matt ceramic texture relief	matt Keramikstruktur reliefiert · matt ceramic texture relief	matt Keramikstruktur reliefiert · matt ceramic texture relief
Material	VilbostonePlus	VilbostonePlus	VilbostonePlus	VilbostonePlus
Maßeinheit · Unit of measure	Feinsteinzeug	Feinsteinzeug	Feinsteinzeug	Feinsteinzeug
Pro Paket · Per box	Porcelain stoneware	Porcelain stoneware	Porcelain stoneware	Porcelain stoneware
Pro Palette · Per pallet	m ² 27,99 kg 1,39 pce	m ² 27,99 kg 1,39 pce	m ² 27,99 kg 1,39 pce	m ² 27,99 kg 1,39 pce
Mindestabgabeneinheit · Min. sales unit	1,44 m ² 40,30 kg 2 pce	1,44 m ² 40,30 kg 2 pce	1,44 m ² 40,30 kg 2 pce	1,44 m ² 40,30 kg 2 pce
Berechnungseinheit · Calculation unit	34,56 m ² 967,20 kg 24 box	34,56 m ² 967,20 kg 24 box	34,56 m ² 967,20 kg 24 box	34,56 m ² 967,20 kg 24 box
Preisgruppe · Price group	P (box)	P (box)	P (box)	P (box)
	m ²	m ²	m ²	m ²
	P130	P130	P130	P130
	60 x 120 cm	60 x 120 cm	60 x 120 cm	60 x 120 cm
Artikelnummer · Article number	2751	2751	2751	2751
Warengruppe · Product group	UL60	UL61	UL62	UL90
Werkmaße · Dimensions (mm)	Grundfliese · Basic tile	Grundfliese · Basic tile	Grundfliese · Basic tile	Grundfliese · Basic tile
Farbe · Colour	595 x 1195 x 12 mm	595 x 1195 x 12 mm	595 x 1195 x 12 mm	595 x 1195 x 12 mm
Oberfläche · Finish	foggy grey	cement grey	concrete grey	asphalt grey
Erzeugnisgruppe	matt Keramikstruktur reliefiert · matt ceramic texture relief	matt Keramikstruktur reliefiert · matt ceramic texture relief	matt Keramikstruktur reliefiert · matt ceramic texture relief	matt Keramikstruktur reliefiert · matt ceramic texture relief
Material	VilbostonePlus	VilbostonePlus	VilbostonePlus	VilbostonePlus
Maßeinheit · Unit of measure	Feinsteinzeug	Feinsteinzeug	Feinsteinzeug	Feinsteinzeug
Pro Paket · Per box	Porcelain stoneware	Porcelain stoneware	Porcelain stoneware	Porcelain stoneware
Pro Palette · Per pallet	m ² 27,99 kg 1,39 pce	m ² 27,99 kg 1,39 pce	m ² 27,99 kg 1,39 pce	m ² 27,99 kg 1,39 pce
Mindestabgabeneinheit · Min. sales unit	1,44 m ² 40,30 kg 2 pce	1,44 m ² 40,30 kg 2 pce	1,44 m ² 40,30 kg 2 pce	1,44 m ² 40,30 kg 2 pce
Berechnungseinheit · Calculation unit	34,56 m ² 967,20 kg 24 box	34,56 m ² 967,20 kg 24 box	34,56 m ² 967,20 kg 24 box	34,56 m ² 967,20 kg 24 box
Preisgruppe · Price group	P (box)	P (box)	P (box)	P (box)
	m ²	m ²	m ²	m ²
	P130	P130	P130	P130

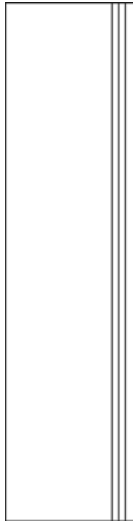
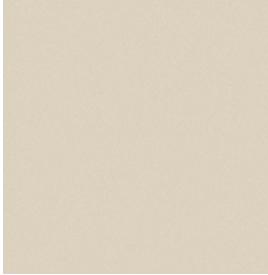
PURE LINE 2.0 Architektur Design (System) · Architecture Design (System)

				
	30 x 120 cm 	30 x 120 cm 	30 x 120 cm 	30 x 120 cm 
Artikelnummer · Article number	2752	2752	2752	2752
Warengruppe · Product group	UL10   	UL70   	UL72   	UL80   
Werkmaße · Dimensions (mm)	Grundfliese · Basic tile 295 x 1195 x 12 mm	Grundfliese · Basic tile 295 x 1195 x 12 mm	Grundfliese · Basic tile 295 x 1195 x 12 mm	Grundfliese · Basic tile 295 x 1195 x 12 mm
Farbe · Colour	ivory	sand beige	clay brown	earth brown
Oberfläche · Finish	matt Keramikstruktur reliefiert · matt ceramic texture relief	matt Keramikstruktur reliefiert · matt ceramic texture relief	matt Keramikstruktur reliefiert · matt ceramic texture relief	matt Keramikstruktur reliefiert · matt ceramic texture relief
Erzeugnisgruppe	VilbostonePlus Feinsteinzeug	VilbostonePlus Feinsteinzeug	VilbostonePlus Feinsteinzeug	VilbostonePlus Feinsteinzeug
Material	Porcelain stoneware	Porcelain stoneware	Porcelain stoneware	Porcelain stoneware
Maßeinheit · Unit of measure	m ² 28 kg 2,78 pce	m ² 28 kg 2,78 pce	m ² 28 kg 2,78 pce	m ² 28 kg 2,78 pce
Pro Paket · Per box	0,72 m ² 20,16 kg 2 pce	0,72 m ² 20,16 kg 2 pce	0,72 m ² 20,16 kg 2 pce	0,72 m ² 20,16 kg 2 pce
Pro Palette · Per pallet	34,56 m ² 967,68 kg 48 box	34,56 m ² 967,68 kg 48 box	34,56 m ² 967,68 kg 48 box	34,56 m ² 967,68 kg 48 box
Mindestabgabereinheit · Min. sales unit	P (box)	P (box)	P (box)	P (box)
Berechnungseinheit · Calculation unit	m ²	m ²	m ²	m ²
Preisgruppe · Price group	P139	P139	P139	P139
				
	30 x 120 cm 	30 x 120 cm 	30 x 120 cm 	30 x 120 cm 
Artikelnummer · Article number	2752	2752	2752	2752
Warengruppe · Product group	UL60   	UL61   	UL62   	UL90   
Werkmaße · Dimensions (mm)	Grundfliese · Basic tile 295 x 1195 x 12 mm	Grundfliese · Basic tile 295 x 1195 x 12 mm	Grundfliese · Basic tile 295 x 1195 x 12 mm	Grundfliese · Basic tile 295 x 1195 x 12 mm
Farbe · Colour	foggy grey	cement grey	concrete grey	asphalt grey
Oberfläche · Finish	matt Keramikstruktur reliefiert · matt ceramic texture relief	matt Keramikstruktur reliefiert · matt ceramic texture relief	matt Keramikstruktur reliefiert · matt ceramic texture relief	matt Keramikstruktur reliefiert · matt ceramic texture relief
Erzeugnisgruppe	VilbostonePlus Feinsteinzeug	VilbostonePlus Feinsteinzeug	VilbostonePlus Feinsteinzeug	VilbostonePlus Feinsteinzeug
Material	Porcelain stoneware	Porcelain stoneware	Porcelain stoneware	Porcelain stoneware
Maßeinheit · Unit of measure	m ² 28 kg 2,78 pce	m ² 28 kg 2,78 pce	m ² 28 kg 2,78 pce	m ² 28 kg 2,78 pce
Pro Paket · Per box	0,72 m ² 20,16 kg 2 pce	0,72 m ² 20,16 kg 2 pce	0,72 m ² 20,16 kg 2 pce	0,72 m ² 20,16 kg 2 pce
Pro Palette · Per pallet	34,56 m ² 967,68 kg 48 box	34,56 m ² 967,68 kg 48 box	34,56 m ² 967,68 kg 48 box	34,56 m ² 967,68 kg 48 box
Mindestabgabereinheit · Min. sales unit	P (box)	P (box)	P (box)	P (box)
Berechnungseinheit · Calculation unit	m ²	m ²	m ²	m ²
Preisgruppe · Price group	P139	P139	P139	P139

PURE LINE 2.0 Architektur Design (System) · Architecture Design (System)

	 <p>30 x 120 cm</p>	 <p>60 x 60 cm</p>	 <p>60 x 60 cm</p>	 <p>60 x 60 cm</p>	
<p>Artikelnummer · Article number</p> <p>Warengruppe · Product group</p> <p>Werkmaße · Dimensions (mm)</p> <p>Farbe · Colour</p> <p>Oberfläche · Finish</p> <p>Erzeugnisgruppe</p> <p>Material</p> <p>Maßeinheit · Unit of measure</p> <p>Pro Paket · Per box</p> <p>Pro Palette · Per pallet</p> <p>Mindestabgabereinheit · Min. sales unit</p> <p>Berechnungseinheit · Calculation unit</p> <p>Preisgruppe · Price group</p>	<p>2732</p> <p>UL10, UL60, UL61 UL62, UL70, UL72 UL80, UL90</p> <p>Treppenauftritt · Stair tread</p> <p>295 x 1195 x 12 mm</p> <p>-</p> <p>matt Keramikstruktur reliefiert · matt ceramic texture relief</p> <p>VilbostonePlus</p> <p>Feinsteinzeug</p> <p>Porcelain stoneware</p> <p>m 5,89 kg 0,83 pce</p> <p>2,41 m 14,20 kg 2 pce</p> <p>106,02 m 624,80 kg 44 box</p> <p>E (pce)</p> <p>Stück · piece</p> <p>E117</p>	<p>2753</p> <p>UL10</p> <p>Grundfliese · Basic tile</p> <p>595 x 595 x 12 mm</p> <p>ivory</p> <p>matt Keramikstruktur reliefiert · matt ceramic texture relief</p> <p>VilbostonePlus</p> <p>Feinsteinzeug</p> <p>Porcelain stoneware</p> <p>m² 28 kg 2,78 pce</p> <p>1,08 m² 30,24 kg 3 pce</p> <p>34,56 m² 967,68 kg 32 box</p> <p>P (box)</p> <p>m²</p> <p>P110</p>	<p>2753</p> <p>UL70</p> <p>Grundfliese · Basic tile</p> <p>595 x 595 x 12 mm</p> <p>sand beige</p> <p>matt Keramikstruktur reliefiert · matt ceramic texture relief</p> <p>VilbostonePlus</p> <p>Feinsteinzeug</p> <p>Porcelain stoneware</p> <p>m² 28 kg 2,78 pce</p> <p>1,08 m² 30,24 kg 3 pce</p> <p>34,56 m² 967,68 kg 32 box</p> <p>P (box)</p> <p>m²</p> <p>P110</p>	<p>2753</p> <p>UL72</p> <p>Grundfliese · Basic tile</p> <p>595 x 595 x 12 mm</p> <p>clay brown</p> <p>matt Keramikstruktur reliefiert · matt ceramic texture relief</p> <p>VilbostonePlus</p> <p>Feinsteinzeug</p> <p>Porcelain stoneware</p> <p>m² 28 kg 2,78 pce</p> <p>1,08 m² 30,24 kg 3 pce</p> <p>34,56 m² 967,68 kg 32 box</p> <p>P (box)</p> <p>m²</p> <p>P110</p>	
	<p>Auftragsbezogene Fertigung der Treppen in der zu bestellten Grundfliese passenden Nuance. Lieferzeit auf Anfrage. Steps made to order in the nuance that matches the basic tile ordered. Delivery time on request.</p>  <p>60 x 60 cm</p>	 <p>60 x 60 cm</p>	 <p>60 x 60 cm</p>	 <p>60 x 60 cm</p>	
	<p>Artikelnummer · Article number</p> <p>Warengruppe · Product group</p> <p>Werkmaße · Dimensions (mm)</p> <p>Farbe · Colour</p> <p>Oberfläche · Finish</p> <p>Erzeugnisgruppe</p> <p>Material</p> <p>Maßeinheit · Unit of measure</p> <p>Pro Paket · Per box</p> <p>Pro Palette · Per pallet</p> <p>Mindestabgabereinheit · Min. sales unit</p> <p>Berechnungseinheit · Calculation unit</p> <p>Preisgruppe · Price group</p>	<p>2753</p> <p>UL80</p> <p>Grundfliese · Basic tile</p> <p>595 x 595 x 12 mm</p> <p>earth brown</p> <p>matt Keramikstruktur reliefiert · matt ceramic texture relief</p> <p>VilbostonePlus</p> <p>Feinsteinzeug</p> <p>Porcelain stoneware</p> <p>m² 28 kg 2,78 pce</p> <p>1,08 m² 30,24 kg 3 pce</p> <p>34,56 m² 967,68 kg 32 box</p> <p>P (box)</p> <p>m²</p> <p>P110</p>	<p>2753</p> <p>UL60</p> <p>Grundfliese · Basic tile</p> <p>595 x 595 x 12 mm</p> <p>foggy grey</p> <p>matt Keramikstruktur reliefiert · matt ceramic texture relief</p> <p>VilbostonePlus</p> <p>Feinsteinzeug</p> <p>Porcelain stoneware</p> <p>m² 28 kg 2,78 pce</p> <p>1,08 m² 30,24 kg 3 pce</p> <p>34,56 m² 967,68 kg 32 box</p> <p>P (box)</p> <p>m²</p> <p>P110</p>	<p>2753</p> <p>UL61</p> <p>Grundfliese · Basic tile</p> <p>595 x 595 x 12 mm</p> <p>cement grey</p> <p>matt Keramikstruktur reliefiert · matt ceramic texture relief</p> <p>VilbostonePlus</p> <p>Feinsteinzeug</p> <p>Porcelain stoneware</p> <p>m² 28 kg 2,78 pce</p> <p>1,08 m² 30,24 kg 3 pce</p> <p>34,56 m² 967,68 kg 32 box</p> <p>P (box)</p> <p>m²</p> <p>P110</p>	<p>2753</p> <p>UL62</p> <p>Grundfliese · Basic tile</p> <p>595 x 595 x 12 mm</p> <p>concrete grey</p> <p>matt Keramikstruktur reliefiert · matt ceramic texture relief</p> <p>VilbostonePlus</p> <p>Feinsteinzeug</p> <p>Porcelain stoneware</p> <p>m² 28 kg 2,78 pce</p> <p>1,08 m² 30,24 kg 3 pce</p> <p>34,56 m² 967,68 kg 32 box</p> <p>P (box)</p> <p>m²</p> <p>P110</p>

PURE LINE 2.0 Architektur Design (System) · Architecture Design (System)

60 x 60 cm	30 x 60 cm	15 x 60 cm	7,5 x 60 cm
2753	2754	2620	2617
UL90	UL10, UL60, UL61 UL62, UL70, UL72 UL80, UL90	UL10, UL60, UL61 UL62, UL70, UL72 UL80, UL90	UL10, UL60, UL61 UL62, UL70, UL72 UL80, UL90
Grundfliese · Basic tile	Grundfliese · Basic tile	Grundfliese · Basic tile	Grundfliese · Basic tile
595 x 595 x 12 mm	295 x 595 x 12 mm	145 x 595 x 12 mm	72 x 595 x 12 mm
asphalt grey	-	-	-
matt Keramikstruktur reliefiert · matt ceramic texture relief	matt Keramikstruktur reliefiert · matt ceramic texture relief	matt Keramikstruktur reliefiert · matt ceramic texture relief	matt Feinadrige Basaloptik reliefiert · matt Fine-veined basalt look relief
VilbostonePlus	VilbostonePlus	VilbostonePlus	VilbostonePlus
Feinsteinzeug	Feinsteinzeug	Feinsteinzeug	Feinsteinzeug
Porcelain stoneware	Porcelain stoneware	Porcelain stoneware	Porcelain stoneware
m ² 28 kg 2,78 pce	m ² 28,06 kg 5,56 pce	m ² 21,67 kg 11,11 pce	m ² 28 kg 22,22 pce
1,08 m ² 30,24 kg 3 pce	0,72 m ² 20,2 kg 4 pce	0,90 m ² 19,50 kg 10 pce	0,90 m ² 25,20 kg 20 pce
34,56 m ² 967,68 kg 32 box	34,56 m ² 969,60 kg 48 box	43,20 m ² 936 kg 48 box	43,20 m ² 1209,60 kg 48 box
P (box)	P (box)	P (box)	P (box)
m ²	m ²	m ²	m ²
P110	P110	P134	P130
7,5 x 7,5 cm	7,5 x 7,5 cm	7,5 x 7,5 cm	7,5 x 7,5 cm
0,09 m ² 297 x 297 mm	0,09 m ² 297 x 297 mm	0,09 m ² 297 x 297 mm	0,09 m ² 297 x 297 mm
2013	2013	2013	2013
UL10	UL70	UL72	UL80
Grundfliese · Basic tile	Grundfliese · Basic tile	Grundfliese · Basic tile	Grundfliese · Basic tile
71,50 x 71,50 x 12 mm	71,50 x 71,50 x 12 mm	71,50 x 71,50 x 12 mm	71,50 x 71,50 x 12 mm
ivory	sand beige	clay brown	earth brown
matt Keramikstruktur reliefiert · matt ceramic texture relief	matt Keramikstruktur reliefiert · matt ceramic texture relief	matt Keramikstruktur reliefiert · matt ceramic texture relief	matt Keramikstruktur reliefiert · matt ceramic texture relief
VilbostonePlus	VilbostonePlus	VilbostonePlus	VilbostonePlus
Feinsteinzeug	Feinsteinzeug	Feinsteinzeug	Feinsteinzeug
Porcelain stoneware	Porcelain stoneware	Porcelain stoneware	Porcelain stoneware
m ² 20,90 kg 11 pce	m ² 20,90 kg 11 pce	m ² 20,90 kg 11 pce	m ² 20,90 kg 11 pce
1 m ² 20,90 kg 11 pce	1 m ² 20,90 kg 11 pce	1 m ² 20,90 kg 11 pce	1 m ² 20,90 kg 11 pce
36 m ² 752,40 kg 36 box	36 m ² 752,40 kg 36 box	36 m ² 752,40 kg 36 box	36 m ² 752,40 kg 36 box
P (box)	P (box)	P (box)	P (box)
m ²	m ²	m ²	m ²
P170	P170	P170	P170
7,5 x 7,5 cm	7,5 x 7,5 cm	7,5 x 7,5 cm	7,5 x 7,5 cm
0,09 m ² 297 x 297 mm	0,09 m ² 297 x 297 mm	0,09 m ² 297 x 297 mm	0,09 m ² 297 x 297 mm
2013	2013	2013	2013
UL60	UL61	UL62	UL90
Grundfliese · Basic tile	Grundfliese · Basic tile	Grundfliese · Basic tile	Grundfliese · Basic tile
71,50 x 71,50 x 12 mm	71,50 x 71,50 x 12 mm	71,50 x 71,50 x 12 mm	71,50 x 71,50 x 12 mm
foggy grey	cement grey	concrete grey	asphalt grey
matt Keramikstruktur reliefiert · matt ceramic texture relief	matt Keramikstruktur reliefiert · matt ceramic texture relief	matt Keramikstruktur reliefiert · matt ceramic texture relief	matt Keramikstruktur reliefiert · matt ceramic texture relief
VilbostonePlus	VilbostonePlus	VilbostonePlus	VilbostonePlus
Feinsteinzeug	Feinsteinzeug	Feinsteinzeug	Feinsteinzeug
Porcelain stoneware	Porcelain stoneware	Porcelain stoneware	Porcelain stoneware
m ² 20,90 kg 11 pce	m ² 20,90 kg 11 pce	m ² 20,90 kg 11 pce	m ² 20,90 kg 11 pce
1 m ² 20,90 kg 11 pce	1 m ² 20,90 kg 11 pce	1 m ² 20,90 kg 11 pce	1 m ² 20,90 kg 11 pce
36 m ² 752,40 kg 36 box	36 m ² 752,40 kg 36 box	36 m ² 752,40 kg 36 box	36 m ² 752,40 kg 36 box
P (box)	P (box)	P (box)	P (box)
m ²	m ²	m ²	m ²
P170	P170	P170	P170

SOLID TONES



60 x 120 cm
NEW 2023



Artikelnummer - Article number	2737
Warengruppe - Product group	PC10
Werkmaße - Dimensions (mm)	Grundfliese - Basic tile
Farbe - Colour	597 x 1197 x 10 mm
Oberfläche - Finish	light concrete
Erzeugnisgruppe	matt Dezente Betonoptik - matt Subtle concrete look VilbostonePlus
Material	Feinsteinzeug
Maßeinheit - Unit of measure	Porcelain stoneware
Pro Paket - Per box	m ² 21,28 kg 1,39 pce
Pro Palette - Per pallet	1,44 m ² 30,64 kg 2 pce
Mindestabgabereinheit - Min. sales unit	43,2 m ² 919,2 kg 30 box
Berechnungseinheit - Calculation unit	P (box)
Preisgruppe - Price group	m ² P110



60 x 120 cm
NEW 2023



Artikelnummer - Article number	2737
Warengruppe - Product group	PC70
Werkmaße - Dimensions (mm)	Grundfliese - Basic tile
Farbe - Colour	597 x 1197 x 10 mm
Oberfläche - Finish	warm concrete
Erzeugnisgruppe	matt Dezente Betonoptik - matt Subtle concrete look VilbostonePlus
Material	Feinsteinzeug
Maßeinheit - Unit of measure	Porcelain stoneware
Pro Paket - Per box	m ² 21,28 kg 1,39 pce
Pro Palette - Per pallet	1,44 m ² 30,64 kg 2 pce
Mindestabgabereinheit - Min. sales unit	43,2 m ² 919,2 kg 30 box
Berechnungseinheit - Calculation unit	P (box)
Preisgruppe - Price group	m ² P110



60 x 120 cm
NEW 2023



Artikelnummer - Article number	2737
Warengruppe - Product group	PC60
Werkmaße - Dimensions (mm)	Grundfliese - Basic tile
Farbe - Colour	597 x 1197 x 10 mm
Oberfläche - Finish	cool concrete
Erzeugnisgruppe	matt Dezente Betonoptik - matt Subtle concrete look VilbostonePlus
Material	Feinsteinzeug
Maßeinheit - Unit of measure	Porcelain stoneware
Pro Paket - Per box	m ² 21,28 kg 1,39 pce
Pro Palette - Per pallet	1,44 m ² 30,64 kg 2 pce
Mindestabgabereinheit - Min. sales unit	43,2 m ² 919,2 kg 30 box
Berechnungseinheit - Calculation unit	P (box)
Preisgruppe - Price group	m ² P110



60 x 120 cm
NEW 2023



Artikelnummer - Article number	2737
Warengruppe - Product group	PC61
Werkmaße - Dimensions (mm)	Grundfliese - Basic tile
Farbe - Colour	597 x 1197 x 10 mm
Oberfläche - Finish	pure concrete
Erzeugnisgruppe	matt Dezente Betonoptik - matt Subtle concrete look VilbostonePlus
Material	Feinsteinzeug
Maßeinheit - Unit of measure	Porcelain stoneware
Pro Paket - Per box	m ² 21,28 kg 1,39 pce
Pro Palette - Per pallet	1,44 m ² 30,64 kg 2 pce
Mindestabgabereinheit - Min. sales unit	43,2 m ² 919,2 kg 30 box
Berechnungseinheit - Calculation unit	P (box)
Preisgruppe - Price group	m ² P110



60 x 120 cm
NEW 2023



Artikelnummer - Article number	2737
Warengruppe - Product group	PC62
Werkmaße - Dimensions (mm)	Grundfliese - Basic tile
Farbe - Colour	597 x 1197 x 10 mm
Oberfläche - Finish	dark concrete
Erzeugnisgruppe	matt Dezente Betonoptik - matt Subtle concrete look VilbostonePlus
Material	Feinsteinzeug
Maßeinheit - Unit of measure	Porcelain stoneware
Pro Paket - Per box	m ² 21,28 kg 1,39 pce
Pro Palette - Per pallet	1,44 m ² 30,64 kg 2 pce
Mindestabgabereinheit - Min. sales unit	43,2 m ² 919,2 kg 30 box
Berechnungseinheit - Calculation unit	P (box)
Preisgruppe - Price group	m ² P110



60 x 120 cm
NEW 2023



Artikelnummer - Article number	2737
Warengruppe - Product group	PS10
Werkmaße - Dimensions (mm)	Grundfliese - Basic tile
Farbe - Colour	597 x 1197 x 10 mm
Oberfläche - Finish	light stone
Erzeugnisgruppe	matt Dezente Steinstruktur - matt Subtle stone structure VilbostonePlus
Material	Feinsteinzeug
Maßeinheit - Unit of measure	Porcelain stoneware
Pro Paket - Per box	m ² 21,28 kg 1,39 pce
Pro Palette - Per pallet	1,44 m ² 30,64 kg 2 pce
Mindestabgabereinheit - Min. sales unit	43,2 m ² 919,2 kg 30 box
Berechnungseinheit - Calculation unit	P (box)
Preisgruppe - Price group	m ² P110



60 x 120 cm
NEW 2023



Artikelnummer - Article number	2737
Warengruppe - Product group	PS70
Werkmaße - Dimensions (mm)	Grundfliese - Basic tile
Farbe - Colour	597 x 1197 x 10 mm
Oberfläche - Finish	warm stone
Erzeugnisgruppe	matt Dezente Steinstruktur - matt Subtle stone structure VilbostonePlus
Material	Feinsteinzeug
Maßeinheit - Unit of measure	Porcelain stoneware
Pro Paket - Per box	m ² 21,28 kg 1,39 pce
Pro Palette - Per pallet	1,44 m ² 30,64 kg 2 pce
Mindestabgabereinheit - Min. sales unit	43,2 m ² 919,2 kg 30 box
Berechnungseinheit - Calculation unit	P (box)
Preisgruppe - Price group	m ² P110



60 x 120 cm
NEW 2023



Artikelnummer - Article number	2737
Warengruppe - Product group	PS60
Werkmaße - Dimensions (mm)	Grundfliese - Basic tile
Farbe - Colour	597 x 1197 x 10 mm
Oberfläche - Finish	cool stone
Erzeugnisgruppe	matt Dezente Steinstruktur - matt Subtle stone structure VilbostonePlus
Material	Feinsteinzeug
Maßeinheit - Unit of measure	Porcelain stoneware
Pro Paket - Per box	m ² 21,28 kg 1,39 pce
Pro Palette - Per pallet	1,44 m ² 30,64 kg 2 pce
Mindestabgabereinheit - Min. sales unit	43,2 m ² 919,2 kg 30 box
Berechnungseinheit - Calculation unit	P (box)
Preisgruppe - Price group	m ² P110

SOLID TONES

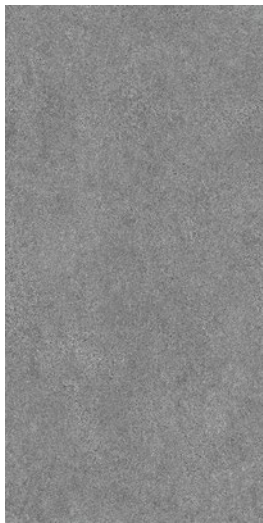

60 x 120 cm
NEW 2023

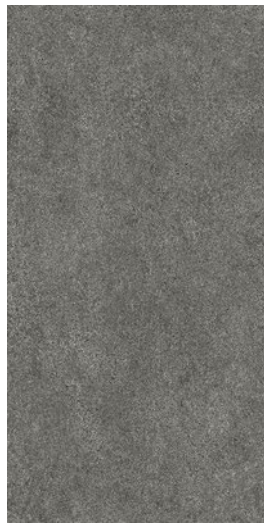

60 x 120 cm
NEW 2023

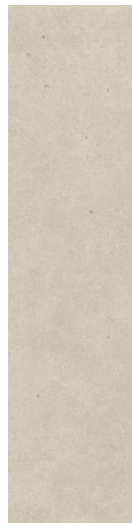

30 x 120 cm
NEW 2023

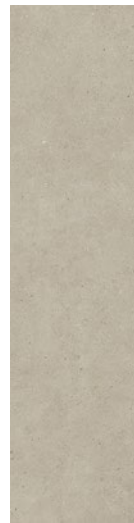

30 x 120 cm
NEW 2023



Artikelnummer - Article number	2737
Warengruppe - Product group	Grundfliese - Basic tile
Werksmaße - Dimensions (mm)	597 x 1197 x 10 mm
Farbe - Colour	pure stone
Oberfläche - Finish	matt Dezente Steinstruktur - matt Subtle stone structure VilbostonePlus
Erzeugnisgruppe	Feinsteinzeug
Material	Porcelain stoneware
Maßeinheit - Unit of measure	m ² 21,28 kg 1,39 pce
Pro Paket - Per box	1,44 m ² 30,64 kg 2 pce
Pro Palette - Per pallet	43,2 m ² 919,2 kg 30 box
Mindestabgabereinheit - Min. sales unit	P (box)
Berechnungseinheit - Calculation unit	m ²
Preisgruppe - Price group	P110

Artikelnummer - Article number	2737
Warengruppe - Product group	Grundfliese - Basic tile
Werksmaße - Dimensions (mm)	597 x 1197 x 10 mm
Farbe - Colour	dark stone
Oberfläche - Finish	matt Dezente Steinstruktur - matt Subtle stone structure VilbostonePlus
Erzeugnisgruppe	Feinsteinzeug
Material	Porcelain stoneware
Maßeinheit - Unit of measure	m ² 21,28 kg 1,39 pce
Pro Paket - Per box	1,44 m ² 30,64 kg 2 pce
Pro Palette - Per pallet	43,2 m ² 919,2 kg 30 box
Mindestabgabereinheit - Min. sales unit	P (box)
Berechnungseinheit - Calculation unit	m ²
Preisgruppe - Price group	P110

Artikelnummer - Article number	2350
Warengruppe - Product group	Grundfliese - Basic tile
Werksmaße - Dimensions (mm)	297 x 1197 x 10 mm
Farbe - Colour	light concrete
Oberfläche - Finish	matt Dezente Betonoptik - matt Subtle concrete look VilbostonePlus
Erzeugnisgruppe	Feinsteinzeug
Material	Porcelain stoneware
Maßeinheit - Unit of measure	m ² 22,31 kg 2,78 pce
Pro Paket - Per box	1,08 m ² 24,09 kg 3 pce
Pro Palette - Per pallet	43,20 m ² 963,60 kg 40 box
Mindestabgabereinheit - Min. sales unit	P (box)
Berechnungseinheit - Calculation unit	m ²
Preisgruppe - Price group	P120

Artikelnummer - Article number	2350
Warengruppe - Product group	Grundfliese - Basic tile
Werksmaße - Dimensions (mm)	297 x 1197 x 10 mm
Farbe - Colour	warm concrete
Oberfläche - Finish	matt Dezente Betonoptik - matt Subtle concrete look VilbostonePlus
Erzeugnisgruppe	Feinsteinzeug
Material	Porcelain stoneware
Maßeinheit - Unit of measure	m ² 22,31 kg 2,78 pce
Pro Paket - Per box	1,08 m ² 24,09 kg 3 pce
Pro Palette - Per pallet	43,20 m ² 963,60 kg 40 box
Mindestabgabereinheit - Min. sales unit	P (box)
Berechnungseinheit - Calculation unit	m ²
Preisgruppe - Price group	P120



30 x 120 cm
NEW 2023

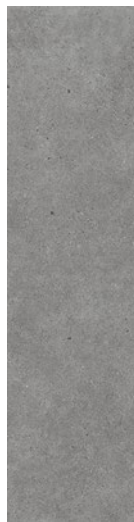

30 x 120 cm
NEW 2023



30 x 120 cm
NEW 2023

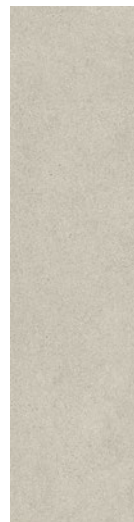

30 x 120 cm
NEW 2023



Artikelnummer - Article number	2350
Warengruppe - Product group	Grundfliese - Basic tile
Werksmaße - Dimensions (mm)	297 x 1197 x 10 mm
Farbe - Colour	cool concrete
Oberfläche - Finish	matt Dezente Betonoptik - matt Subtle concrete look VilbostonePlus
Erzeugnisgruppe	Feinsteinzeug
Material	Porcelain stoneware
Maßeinheit - Unit of measure	m ² 22,31 kg 2,78 pce
Pro Paket - Per box	1,08 m ² 24,09 kg 3 pce
Pro Palette - Per pallet	43,20 m ² 963,60 kg 40 box
Mindestabgabereinheit - Min. sales unit	P (box)
Berechnungseinheit - Calculation unit	m ²
Preisgruppe - Price group	P120

Artikelnummer - Article number	2350
Warengruppe - Product group	Grundfliese - Basic tile
Werksmaße - Dimensions (mm)	297 x 1197 x 10 mm
Farbe - Colour	pure concrete
Oberfläche - Finish	matt Dezente Betonoptik - matt Subtle concrete look VilbostonePlus
Erzeugnisgruppe	Feinsteinzeug
Material	Porcelain stoneware
Maßeinheit - Unit of measure	m ² 22,31 kg 2,78 pce
Pro Paket - Per box	1,08 m ² 24,09 kg 3 pce
Pro Palette - Per pallet	43,20 m ² 963,60 kg 40 box
Mindestabgabereinheit - Min. sales unit	P (box)
Berechnungseinheit - Calculation unit	m ²
Preisgruppe - Price group	P120

Artikelnummer - Article number	2350
Warengruppe - Product group	Grundfliese - Basic tile
Werksmaße - Dimensions (mm)	297 x 1197 x 10 mm
Farbe - Colour	dark concrete
Oberfläche - Finish	matt Dezente Betonoptik - matt Subtle concrete look VilbostonePlus
Erzeugnisgruppe	Feinsteinzeug
Material	Porcelain stoneware
Maßeinheit - Unit of measure	m ² 22,31 kg 2,78 pce
Pro Paket - Per box	1,08 m ² 24,09 kg 3 pce
Pro Palette - Per pallet	43,20 m ² 963,60 kg 40 box
Mindestabgabereinheit - Min. sales unit	P (box)
Berechnungseinheit - Calculation unit	m ²
Preisgruppe - Price group	P120

Artikelnummer - Article number	2350
Warengruppe - Product group	Grundfliese - Basic tile
Werksmaße - Dimensions (mm)	297 x 1197 x 10 mm
Farbe - Colour	light stone
Oberfläche - Finish	matt Dezente Steinstruktur - matt Subtle stone structure VilbostonePlus
Erzeugnisgruppe	Feinsteinzeug
Material	Porcelain stoneware
Maßeinheit - Unit of measure	m ² 22,31 kg 2,78 pce
Pro Paket - Per box	1,08 m ² 24,09 kg 3 pce
Pro Palette - Per pallet	43,20 m ² 963,60 kg 40 box
Mindestabgabereinheit - Min. sales unit	P (box)
Berechnungseinheit - Calculation unit	m ²
Preisgruppe - Price group	P120

SOLID TONES

Architektur Design (System) · Architecture Design (System)

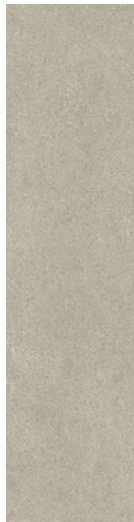

30 x 120 cm
NEW 2023

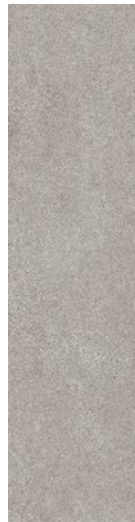

30 x 120 cm
NEW 2023

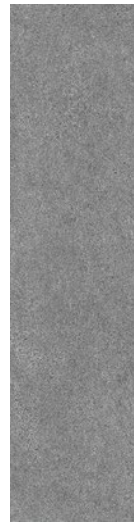

30 x 120 cm
NEW 2023

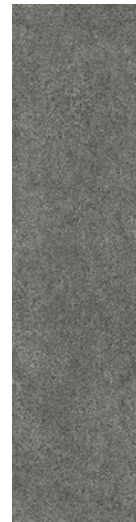

30 x 120 cm
NEW 2023



Artikelnummer · Article number	2350	2350	2350	2350
	PS70	PS60	PS61	PS62
Warengruppe · Product group	Grundfliese · Basic tile	Grundfliese · Basic tile	Grundfliese · Basic tile	Grundfliese · Basic tile
Werkmaße · Dimensions (mm)	297 x 1197 x 10 mm	297 x 1197 x 10 mm	297 x 1197 x 10 mm	297 x 1197 x 10 mm
Farbe · Colour	warm stone	cool stone	pure stone	dark stone
Oberfläche · Finish	matt Dezente Steinstruktur · matt Subtle stone structure VilbostonePlus	matt Dezente Steinstruktur · matt Subtle stone structure VilbostonePlus	matt Dezente Steinstruktur · matt Subtle stone structure VilbostonePlus	matt Dezente Steinstruktur · matt Subtle stone structure VilbostonePlus
Erzeugnisgruppe	Feinsteinzeug	Feinsteinzeug	Feinsteinzeug	Feinsteinzeug
Material	Porcelain stoneware	Porcelain stoneware	Porcelain stoneware	Porcelain stoneware
Maßeinheit · Unit of measure	m ² 22,31 kg 2,78 pce	m ² 22,31 kg 2,78 pce	m ² 22,31 kg 2,78 pce	m ² 22,31 kg 2,78 pce
Pro Paket · Per box	1,08 m ² 24,09 kg 3 pce	1,08 m ² 24,09 kg 3 pce	1,08 m ² 24,09 kg 3 pce	1,08 m ² 24,09 kg 3 pce
Pro Palette · Per pallet	43,20 m ² 963,60 kg 40 box	43,20 m ² 963,60 kg 40 box	43,20 m ² 963,60 kg 40 box	43,20 m ² 963,60 kg 40 box
Mindestabgabereinheit · Min. sales unit	P (box)	P (box)	P (box)	P (box)
Berechnungseinheit · Calculation unit	m ²	m ²	m ²	m ²
Preisgruppe · Price group	P120	P120	P120	P120

SOLID TONES

Architektur Design (System) · Architecture Design (System)



Artikelnummer · Article number Warengruppe · Product group Werksmaße · Dimensions (mm) Farbe · Colour Oberfläche · Finish Erzeugnisgruppe Material Maßeinheit · Unit of measure Pro Paket · Per box Pro Palette · Per pallet Mindestabgabeneinheit · Min. sales unit Berechnungseinheit · Calculation unit Preisgruppe · Price group	2732 PC10, PC60, PC61 PC62, PC70, PS10 PS60, PS61, PS62 PS70 Treppenauftritt · Stair tread 297 x 1197 x 10 mm - matt Dezente Betonoptik · matt Subtle concrete look VilbostonePlus Feinsteinzeug Porcelain stoneware m 5,89 kg 0,83 pce 2,41 m 14,20 kg 2 pce 106,02 m 624,80 kg 44 box E (pce) Stück · piece E118	2310 PC10 Grundfliese · Basic tile 597 x 597 x 10 mm light concrete matt Dezente Betonoptik · matt Subtle concrete look VilbostonePlus Feinsteinzeug Porcelain stoneware m ² 22,31 kg 2,78 pce 1,44 m ² 32,12 kg 4 pce 43,20 m ² 963,60 kg 30 box P (box) m ² P90	2310 PC70 Grundfliese · Basic tile 597 x 597 x 10 mm warm concrete matt Dezente Betonoptik · matt Subtle concrete look VilbostonePlus Feinsteinzeug Porcelain stoneware m ² 22,31 kg 2,78 pce 1,44 m ² 32,12 kg 4 pce 43,20 m ² 963,60 kg 30 box P (box) m ² P90	2310 PC60 Grundfliese · Basic tile 597 x 597 x 10 mm cool concrete matt Dezente Betonoptik · matt Subtle concrete look VilbostonePlus Feinsteinzeug Porcelain stoneware m ² 22,31 kg 2,78 pce 1,44 m ² 32,12 kg 4 pce 43,20 m ² 963,60 kg 30 box P (box) m ² P90
--	---	---	--	--

Auftragsbezogene Fertigung der Treppen in der zu bestellten Grundfliese passenden Nuance. Lieferzeit auf Anfrage.
 Steps made to order in the nuance that matches the basic tile ordered. Delivery time on request.



Artikelnummer · Article number Warengruppe · Product group Werksmaße · Dimensions (mm) Farbe · Colour Oberfläche · Finish Erzeugnisgruppe Material Maßeinheit · Unit of measure Pro Paket · Per box Pro Palette · Per pallet Mindestabgabeneinheit · Min. sales unit Berechnungseinheit · Calculation unit Preisgruppe · Price group	2310 PC61 Grundfliese · Basic tile 597 x 597 x 10 mm pure concrete matt Dezente Betonoptik · matt Subtle concrete look VilbostonePlus Feinsteinzeug Porcelain stoneware m ² 22,31 kg 2,78 pce 1,44 m ² 32,12 kg 4 pce 43,20 m ² 963,60 kg 30 box P (box) m ² P90	2310 PC62 Grundfliese · Basic tile 597 x 597 x 10 mm dark concrete matt Dezente Betonoptik · matt Subtle concrete look VilbostonePlus Feinsteinzeug Porcelain stoneware m ² 22,31 kg 2,78 pce 1,44 m ² 32,12 kg 4 pce 43,20 m ² 963,60 kg 30 box P (box) m ² P90	2310 PS10 Grundfliese · Basic tile 597 x 597 x 10 mm light stone matt Dezente Steinstruktur · matt Subtle stone structure VilbostonePlus Feinsteinzeug Porcelain stoneware m ² 22,31 kg 2,78 pce 1,44 m ² 32,12 kg 4 pce 43,20 m ² 963,60 kg 30 box P (box) m ² P90	2310 PS70 Grundfliese · Basic tile 597 x 597 x 10 mm warm stone matt Dezente Steinstruktur · matt Subtle stone structure VilbostonePlus Feinsteinzeug Porcelain stoneware m ² 22,31 kg 2,78 pce 1,44 m ² 32,12 kg 4 pce 43,20 m ² 963,60 kg 30 box P (box) m ² P90
--	--	--	---	--

SOLID TONES

Architektur Design (System) · Architecture Design (System)

	60 x 60 cm NEW 2023	60 x 60 cm NEW 2023	60 x 60 cm NEW 2023	30 x 60 cm NEW 2023
Artikelnummer · Article number	2310	2310	2310	2685
	PS60	PS61	PS62	PC10, PC60, PC61 PC62, PC70, PS10 PS60, PS61, PS62 PS70
Warengruppe · Product group	Grundfliese · Basic tile	Grundfliese · Basic tile	Grundfliese · Basic tile	Grundfliese · Basic tile
Werkmaße · Dimensions (mm)	597 x 597 x 10 mm	597 x 597 x 10 mm	597 x 597 x 10 mm	297 x 597 x 10 mm
Farbe · Colour	cool stone	pure stone	dark stone	-
Oberfläche · Finish	matt Dezente Steinstruktur · matt Subtle stone structure VilbostonePlus	matt Dezente Steinstruktur · matt Subtle stone structure VilbostonePlus	matt Dezente Steinstruktur · matt Subtle stone structure VilbostonePlus	matt VilbostonePlus
Erzeugnisgruppe	Feinsteinzeug	Feinsteinzeug	Feinsteinzeug	Feinsteinzeug
Material	Porcelain stoneware	Porcelain stoneware	Porcelain stoneware	Porcelain stoneware
Maßeinheit · Unit of measure	m ² 22,31 kg 2,78 pce	m ² 22,31 kg 2,78 pce	m ² 22,31 kg 2,78 pce	m ² 22,28 kg 5,56 pce
Pro Paket · Per box	1,44 m ² 32,12 kg 4 pce	1,44 m ² 32,12 kg 4 pce	1,44 m ² 32,12 kg 4 pce	1,08 m ² 24,06 kg 6 pce
Pro Palette · Per pallet	43,20 m ² 963,60 kg 30 box	43,20 m ² 963,60 kg 30 box	43,20 m ² 963,60 kg 30 box	43,20 m ² 962,40 kg 40 box
Mindestabgabeneinheit · Min. sales unit	P (box)	P (box)	P (box)	P (box)
Berechnungseinheit · Calculation unit	m ²	m ²	m ²	m ²
Preisgruppe · Price group	P90	P90	P90	P87
	30 x 60 cm NEW 2023	30 x 30 cm NEW 2023	20 x 60 cm NEW 2023	10 x 60 cm NEW 2023
Artikelnummer · Article number	2521	2578	2621	2417
	PC10, PC60, PC61 PC62, PC70, PS10 PS60, PS61, PS62 PS70	PC10, PC60, PC61 PC62, PC70, PS10 PS60, PS61, PS62 PS70	PC10, PC60, PC61 PC62, PC70, PS10 PS60, PS61, PS62 PS70	PC10, PC60, PC61 PC62, PC70, PS10 PS60, PS61, PS62 PS70
Warengruppe · Product group	Grundfliese · Basic tile	Grundfliese · Basic tile	Grundfliese · Basic tile	Grundfliese · Basic tile
Werkmaße · Dimensions (mm)	297 x 597 x 10 mm	297 x 297 x 10 mm	197 x 597 x 10 mm	97 x 597 x 10 mm
Farbe · Colour	-	-	-	-
Oberfläche · Finish	matt VilbostonePlus	matt VilbostonePlus	matt VilbostonePlus	matt VilbostonePlus
Erzeugnisgruppe	Feinsteinzeug	Feinsteinzeug	Feinsteinzeug	Feinsteinzeug
Material	Porcelain stoneware	Porcelain stoneware	Porcelain stoneware	Porcelain stoneware
Maßeinheit · Unit of measure	m ² 22,28 kg 5,56 pce	m ² 22,33 kg 11 pce	m ² 22,33 kg 8,33 pce	m ² 22,33 kg 16,67 pce
Pro Paket · Per box	1,08 m ² 24,06 kg 6 pce	1 m ² 22,33 kg 11 pce	0,72 m ² 16,08 kg 6 pce	0,60 m ² 13,40 kg 10 pce
Pro Palette · Per pallet	43,20 m ² 962,40 kg 40 box	48 m ² 1071,84 kg 48 box	43,20 m ² 964,80 kg 60 box	36 m ² 804 kg 60 box
Mindestabgabeneinheit · Min. sales unit	P (box)	P (box)	P (box)	P (box)
Berechnungseinheit · Calculation unit	m ²	m ²	m ²	m ²
Preisgruppe · Price group	P87	P93	P120	P120











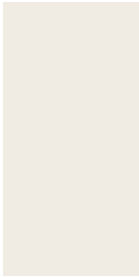
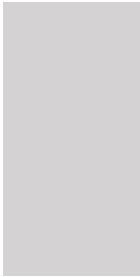
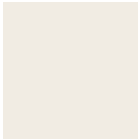









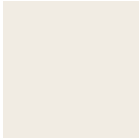























SOLID TONES

Architektur Design (System) · Architecture Design (System)

	5 x 60 cm NEW 2023	10 x 10 cm NEW 2023 □ 0,09 m ² 297 x 297 mm	10 x 10 cm NEW 2023 □ 0,09 m ² 297 x 297 mm	10 x 10 cm NEW 2023 □ 0,09 m ² 297 x 297 mm
Artikelnummer · Article number	2854	2012	2012	2012
Warengruppe · Product group	PC10, PC60, PC61 PC62, PC70, PS10 PS60, PS61, PS62 PS70	PC10	PC70	PC60
Werkgröße · Dimensions (mm)	47 x 597 x 10 mm	97 x 97 x 10 mm	97 x 97 x 10 mm	97 x 97 x 10 mm
Farbe · Colour	-	light concrete	warm concrete	cool concrete
Oberfläche · Finish	matt VilbostonePlus	matt Dezente Betonoptik · matt Subtle concrete look VilbostonePlus	matt Dezente Betonoptik · matt Subtle concrete look VilbostonePlus	matt Dezente Betonoptik · matt Subtle concrete look VilbostonePlus
Erzeugnisgruppe	Feinsteinzeug	Feinsteinzeug	Feinsteinzeug	Feinsteinzeug
Material	Porcelain stoneware	Porcelain stoneware	Porcelain stoneware	Porcelain stoneware
Maßeinheit · Unit of measure	m ² 22,33 kg 33,33 pce	m ² 22,11 kg 11 pce	m ² 22,11 kg 11 pce	m ² 22,11 kg 11 pce
Pro Paket · Per box	0,48 m ² 10,72 kg 16 pce	1 m ² 22,11 kg 11 pce	1 m ² 22,11 kg 11 pce	1 m ² 22,11 kg 11 pce
Pro Palette · Per pallet	42,24 m ² 943,36 kg 88 box	36 m ² 795,96 kg 36 box	36 m ² 795,96 kg 36 box	36 m ² 795,96 kg 36 box
Mindestabgabeneinheit · Min. sales unit	P (box)	P (box)	P (box)	P (box)
Berechnungseinheit · Calculation unit	m ²	m ²	m ²	m ²
Preisgruppe · Price group	P120	P156	P156	P156
	10 x 10 cm NEW 2023 □ 0,09 m ² 297 x 297 mm	10 x 10 cm NEW 2023 □ 0,09 m ² 297 x 297 mm	10 x 10 cm NEW 2023 □ 0,09 m ² 297 x 297 mm	10 x 10 cm NEW 2023 □ 0,09 m ² 297 x 297 mm
Artikelnummer · Article number	2012	2012	2012	2012
Warengruppe · Product group	PC61	PC62	PS10	PS70
Werkgröße · Dimensions (mm)	97 x 97 x 10 mm	97 x 97 x 10 mm	97 x 97 x 10 mm	97 x 97 x 10 mm
Farbe · Colour	pure concrete	dark concrete	light stone	warm stone
Oberfläche · Finish	matt Dezente Betonoptik · matt Subtle concrete look VilbostonePlus	matt Dezente Betonoptik · matt Subtle concrete look VilbostonePlus	matt Dezente Steinstruktur · matt Subtle stone structure VilbostonePlus	matt Dezente Steinstruktur · matt Subtle stone structure VilbostonePlus
Erzeugnisgruppe	Feinsteinzeug	Feinsteinzeug	Feinsteinzeug	Feinsteinzeug
Material	Porcelain stoneware	Porcelain stoneware	Porcelain stoneware	Porcelain stoneware
Maßeinheit · Unit of measure	m ² 22,11 kg 11 pce	m ² 22,11 kg 11 pce	m ² 22,11 kg 11 pce	m ² 22,11 kg 11 pce
Pro Paket · Per box	1 m ² 22,11 kg 11 pce	1 m ² 22,11 kg 11 pce	1 m ² 22,11 kg 11 pce	1 m ² 22,11 kg 11 pce
Pro Palette · Per pallet	36 m ² 795,96 kg 36 box	36 m ² 795,96 kg 36 box	36 m ² 795,96 kg 36 box	36 m ² 795,96 kg 36 box
Mindestabgabeneinheit · Min. sales unit	P (box)	P (box)	P (box)	P (box)
Berechnungseinheit · Calculation unit	m ²	m ²	m ²	m ²
Preisgruppe · Price group	P156	P156	P156	P156
	10 x 10 cm NEW 2023 □ 0,09 m ² 297 x 297 mm	10 x 10 cm NEW 2023 □ 0,09 m ² 297 x 297 mm	10 x 10 cm NEW 2023 □ 0,09 m ² 297 x 297 mm	10 x 30 cm NEW 2023
Artikelnummer · Article number	2012	2012	2012	2493
Warengruppe · Product group	PS60	PS61	PS62	PC10, PC60, PC61 PC62, PC70, PS10 PS60, PS61, PS62 PS70
Werkgröße · Dimensions (mm)	97 x 97 x 10 mm	97 x 97 x 10 mm	97 x 97 x 10 mm	107 x 297 x 9 mm
Farbe · Colour	cool stone	pure stone	dark stone	-
Oberfläche · Finish	matt Dezente Steinstruktur · matt Subtle stone structure VilbostonePlus	matt Dezente Steinstruktur · matt Subtle stone structure VilbostonePlus	matt Dezente Steinstruktur · matt Subtle stone structure VilbostonePlus	matt VilbostonePlus
Erzeugnisgruppe	Feinsteinzeug	Feinsteinzeug	Feinsteinzeug	Feinsteinzeug
Material	Porcelain stoneware	Porcelain stoneware	Porcelain stoneware	Porcelain stoneware
Maßeinheit · Unit of measure	m ² 22,11 kg 11 pce	m ² 22,11 kg 11 pce	m ² 22,11 kg 11 pce	m 1,67 kg 3,33 pce
Pro Paket · Per box	1 m ² 22,11 kg 11 pce	1 m ² 22,11 kg 11 pce	1 m ² 22,11 kg 11 pce	6,01 m 10 kg 20 pce
Pro Palette · Per pallet	36 m ² 795,96 kg 36 box	36 m ² 795,96 kg 36 box	36 m ² 795,96 kg 36 box	420,42 m 700 kg 70 box
Mindestabgabeneinheit · Min. sales unit	P (box)	P (box)	P (box)	E (pce)
Berechnungseinheit · Calculation unit	m ²	m ²	m ²	m ²
Preisgruppe · Price group	P156	P156	P156	E47

UNIT ONE

Architektur Design (Basis) · Architecture Design (Basis)

				
	30 x 60 cm	30 x 60 cm	30 x 30 cm	30 x 30 cm
Artikelnummer · Article number	2343	2343	3135	3135
	UT01  	UT02  	UT01  	UT02  
Warengruppe · Product group	Grundfliese · Basic tile	Grundfliese · Basic tile	Grundfliese · Basic tile	Grundfliese · Basic tile
Werkmaße · Dimensions (mm)	297 x 597 x 9 mm	297 x 597 x 9 mm	296 x 296 x 7 mm	296 x 296 x 7 mm
Farbe · Colour	white	grey	white	grey
Oberfläche · Finish	matt Unifarbene Glasur · matt Plain-coloured glaze	matt Unifarbene Glasur · matt Plain-coloured glaze	matt Unifarbene Glasur · matt Plain-coloured glaze	matt Unifarbene Glasur · matt Plain-coloured glaze
Erzeugnisgruppe	Feinsteinzeug glasiert	Feinsteinzeug glasiert	Steinzeug glasiert	Steinzeug glasiert
Material	Glazed porcelain stoneware	Glazed porcelain stoneware	Glazed vitreous	Glazed vitreous
Maßeinheit · Unit of measure	m ² 17,06 kg 5,56 pce	m ² 17,06 kg 5,56 pce	m ² 14,52 kg 11 pce	m ² 14,52 kg 11 pce
Pro Paket · Per box	1,08 m ² 18,42 kg 6 pce	1,08 m ² 18,42 kg 6 pce	1 m ² 14,52 kg 11 pce	1 m ² 14,52 kg 11 pce
Pro Palette · Per pallet	43,20 m ² 736,80 kg 40 box	43,20 m ² 736,80 kg 40 box	72 m ² 1045,44 kg 72 box	72 m ² 1045,44 kg 72 box
Mindestabgabereinheit · Min. sales unit	P (box)	P (box)	P (box)	P (box)
Berechnungseinheit · Calculation unit	m ²	m ²	m ²	m ²
Preisgruppe · Price group	P87	P87	P87	P87
				
	30 x 30 cm	20 x 20 cm	20 x 20 cm	20 x 20 cm
Artikelnummer · Article number	3130	3171	3171	3177
	UT03   R9 	UT01   	UT02   	UT01, UT02   R10  
Warengruppe · Product group	Grundfliese · Basic tile	Grundfliese · Basic tile	Grundfliese · Basic tile	Grundfliese · Basic tile
Werkmaße · Dimensions (mm)	296 x 296 x 7 mm	197 x 197 x 6 mm	197 x 197 x 6 mm	197 x 197 x 6 mm
Farbe · Colour	creme	white	grey	-
Oberfläche · Finish	matt Unifarbene Glasur · matt Plain-coloured glaze	matt Unifarbene Glasur · matt Plain-coloured glaze	matt Unifarbene Glasur · matt Plain-coloured glaze	matt Unifarbene Glasur · matt Plain-coloured glaze
Erzeugnisgruppe	Steinzeug glasiert	Steinzeug glasiert	Steinzeug glasiert	Steinzeug glasiert
Material	Glazed vitreous	Glazed vitreous	Glazed vitreous	Glazed vitreous
Maßeinheit · Unit of measure	m ² 14,52 kg 11 pce	m ² 13,25 kg 25 pce	m ² 13,25 kg 25 pce	m ² 13,25 kg 25 pce
Pro Paket · Per box	1 m ² 14,52 kg 11 pce	1 m ² 13,25 kg 25 pce	1 m ² 13,25 kg 25 pce	1 m ² 13,25 kg 25 pce
Pro Palette · Per pallet	72 m ² 1045,44 kg 72 box	81 m ² 1073,25 kg 81 box	81 m ² 1073,25 kg 81 box	81 m ² 1073,25 kg 81 box
Mindestabgabereinheit · Min. sales unit	P (box)	P (box)	P (box)	P (box)
Berechnungseinheit · Calculation unit	m ²	m ²	m ²	m ²
Preisgruppe · Price group	P87	P73	P73	P76
				
	15 x 15 cm	15 x 15 cm	15 x 15 cm	10 x 20 cm
Artikelnummer · Article number	3103	3103	3105	3215
	UT01   	UT02   	UT01, UT02   R10  	UT01   
Warengruppe · Product group	Grundfliese · Basic tile	Grundfliese · Basic tile	Grundfliese · Basic tile	Grundfliese · Basic tile
Werkmaße · Dimensions (mm)	147 x 147 x 6 mm	147 x 147 x 6 mm	147 x 147 x 6 mm	97 x 197 x 6 mm
Farbe · Colour	white	grey	-	white
Oberfläche · Finish	matt Unifarbene Glasur · matt Plain-coloured glaze	matt Unifarbene Glasur · matt Plain-coloured glaze	matt Unifarbene Glasur · matt Plain-coloured glaze	matt Unifarbene Glasur · matt Plain-coloured glaze
Erzeugnisgruppe	Steinzeug glasiert	Steinzeug glasiert	Steinzeug glasiert	Steinzeug glasiert
Material	Glazed vitreous	Glazed vitreous	Glazed vitreous	Glazed vitreous
Maßeinheit · Unit of measure	m ² 12,32 kg 44 pce	m ² 12,32 kg 44 pce	m ² 12,76 kg 44 pce	m ² 12,50 kg 50 pce
Pro Paket · Per box	1 m ² 12,32 kg 44 pce	1 m ² 12,32 kg 44 pce	1 m ² 12,76 kg 44 pce	1 m ² 12,50 kg 50 pce
Pro Palette · Per pallet	80 m ² 985,60 kg 80 box	80 m ² 985,60 kg 80 box	80 m ² 1020,80 kg 80 box	72 m ² 900 kg 72 box
Mindestabgabereinheit · Min. sales unit	P (box)	P (box)	P (box)	P (box)
Berechnungseinheit · Calculation unit	m ²	m ²	m ²	m ²
Preisgruppe · Price group	P87	P87	P87	P87

UNIT ONE

Architektur Design (Basis) · Architecture Design (Basis)

Artikelnummer · Article number	3215	3215	3350	3350
Warengruppe · Product group	UT21	UT02	UT01	UT03
Werkmaße · Dimensions (mm)	Grundfliese · Basic tile 97 x 197 x 6 mm	Grundfliese · Basic tile 97 x 197 x 6 mm	Grundfliese · Basic tile 97 x 297 x 6 mm	Grundfliese · Basic tile 97 x 297 x 6 mm
Farbe · Colour	white	grey	white	creme
Oberfläche · Finish	glänzend Unifarbene Glasur · glossy Plain-coloured glaze	matt Unifarbene Glasur · matt Plain-coloured glaze	matt Unifarbene Glasur · matt Plain-coloured glaze	matt Unifarbene Glasur · matt Plain-coloured glaze
Erzeugnisgruppe	Steinzeug glasiert	Steinzeug glasiert	Steinzeug glasiert	Steinzeug glasiert
Material	Glazed vitreous	Glazed vitreous	Glazed vitreous	Glazed vitreous
Maßeinheit · Unit of measure	m ² 12,50 kg 50 pce	m ² 12,50 kg 50 pce	m ² 12,21 kg 33 pce	m ² 12,21 kg 33 pce
Pro Paket · Per box	1 m ² 12,50 kg 50 pce	1 m ² 12,50 kg 50 pce	1 m ² 12,21 kg 33 pce	1 m ² 12,21 kg 33 pce
Pro Palette · Per pallet	72 m ² 900 kg 72 box	72 m ² 900 kg 72 box	72 m ² 879,12 kg 72 box	72 m ² 879,12 kg 72 box
Mindestabgabeneinheit · Min. sales unit	P (box)	P (box)	P (box)	P (box)
Berechnungseinheit · Calculation unit	m ²	m ²	m ²	m ²
Preisgruppe · Price group	P89	P87	P79	P79
Artikelnummer · Article number	3350	3201	3201	3201
Warengruppe · Product group	UT21	UT01	UT02	UT21
Werkmaße · Dimensions (mm)	Grundfliese · Basic tile 97 x 297 x 6 mm	Grundfliese · Basic tile 97 x 97 x 6 mm	Grundfliese · Basic tile 97 x 97 x 6 mm	Grundfliese · Basic tile 97 x 97 x 6 mm
Farbe · Colour	white	white	grey	white
Oberfläche · Finish	glänzend Unifarbene Glasur · glossy Plain-coloured glaze	matt Unifarbene Glasur · matt Plain-coloured glaze	matt Unifarbene Glasur · matt Plain-coloured glaze	glänzend Unifarbene Glasur · glossy Plain-coloured glaze
Erzeugnisgruppe	Steinzeug glasiert	Steinzeug glasiert	Steinzeug glasiert	Steinzeug glasiert
Material	Glazed vitreous	Glazed vitreous	Glazed vitreous	Glazed vitreous
Maßeinheit · Unit of measure	m ² 12,21 kg 33 pce	m ² 12,10 kg 11 pce	m ² 12,10 kg 11 pce	m ² 12,10 kg 11 pce
Pro Paket · Per box	1 m ² 12,21 kg 33 pce	1 m ² 12,10 kg 11 pce	1 m ² 12,10 kg 11 pce	1 m ² 12,10 kg 11 pce
Pro Palette · Per pallet	72 m ² 879,12 kg 72 box	78 m ² 943,80 kg 78 box	78 m ² 943,80 kg 78 box	78 m ² 943,80 kg 78 box
Mindestabgabeneinheit · Min. sales unit	P (box)	P (box)	P (box)	P (box)
Berechnungseinheit · Calculation unit	m ²	m ²	m ²	m ²
Preisgruppe · Price group	P96	P87	P87	P98
Artikelnummer · Article number	3201	3244	3244	3245
Warengruppe · Product group	UT22	UT01	UT02	UT01
Werkmaße · Dimensions (mm)	Grundfliese · Basic tile 97 x 97 x 6 mm	Grundfliese · Basic tile 97 x 97 x 6 mm	Grundfliese · Basic tile 97 x 97 x 6 mm	Grundfliese · Basic tile 97 x 97 x 6 mm
Farbe · Colour	grey	white	grey	white
Oberfläche · Finish	glänzend Unifarbene Glasur · glossy Plain-coloured glaze	matt Unifarbene Glasur · matt Plain-coloured glaze	matt Unifarbene Glasur · matt Plain-coloured glaze	matt Unifarbene Glasur · matt Plain-coloured glaze
Erzeugnisgruppe	Steinzeug glasiert	Steinzeug glasiert	Steinzeug glasiert	Steinzeug glasiert
Material	Glazed vitreous	Glazed vitreous	Glazed vitreous	Glazed vitreous
Maßeinheit · Unit of measure	m ² 12,10 kg 11 pce	m ² 12,10 kg 11 pce	m ² 12,10 kg 11 pce	m ² 12,10 kg 11 pce
Pro Paket · Per box	1 m ² 12,10 kg 11 pce	1 m ² 12,10 kg 11 pce	1 m ² 12,10 kg 11 pce	1 m ² 12,10 kg 11 pce
Pro Palette · Per pallet	78 m ² 943,80 kg 78 box	78 m ² 943,80 kg 78 box	78 m ² 943,80 kg 78 box	78 m ² 943,80 kg 78 box
Mindestabgabeneinheit · Min. sales unit	P (box)	P (box)	P (box)	P (box)
Berechnungseinheit · Calculation unit	m ²	m ²	m ²	m ²
Preisgruppe · Price group	P98	P99	P99	P104

UNIT ONE Architektur Design (Basis) · Architecture Design (Basis)

10 x 10 cm □ 0,09 m ² 297 x 297 mm	5 x 5 cm □ 0,09 m ² 298 x 298 mm	5 x 5 cm □ 0,09 m ² 298 x 298 mm	8 x 30 cm
3245	3709	3709	3242
UT02	UT01	UT02	UT01, UT02
Grundfliese · Basic tile	Grundfliese · Basic tile	Grundfliese · Basic tile	Sockel · Skirting
Werkmaße · Dimensions (mm) 97 x 97 x 6 mm	48 x 48 x 6 mm	48 x 48 x 6 mm	80 x 296 x 8 mm
Farbe · Colour grey	white	grey	-
Oberfläche · Finish matt Unifarbene Glasur · matt Plain-coloured glaze	matt Unifarbene Glasur · matt Plain-coloured glaze	matt Unifarbene Glasur · matt Plain-coloured glaze	matt Unifarbene Glasur · matt Plain-coloured glaze
Erzeugnisgruppe Steinzeug glasiert	Steinzeug glasiert	Steinzeug glasiert	Steinzeug glasiert
Material Glazed vitreous	Glazed vitreous	Glazed vitreous	Glazed vitreous
Maßeinheit · Unit of measure m ² 12,10 kg 11 pce	m ² 11,77 kg 11 pce	m ² 11,77 kg 11 pce	m 1,37 kg 3,33 pce
Pro Paket · Per box 1 m ² 12,10 kg 11 pce	1 m ² 11,77 kg 11 pce	1 m ² 11,77 kg 11 pce	6,01 m 8,20 kg 20 pce
Pro Palette · Per pallet 78 m ² 943,80 kg 78 box	78 m ² 918,06 kg 78 box	78 m ² 918,06 kg 78 box	-
Mindestabgabereinheit · Min. sales unit P (box)	P (box)	P (box)	E (pce)
Berechnungseinheit · Calculation unit m ²	m ²	m ²	Stück · piece
Preisgruppe · Price group P104	P93	P93	E24
<p>Wegen der unterschiedlichen Produktionsverfahren von Fliesen und Formstücken können leichte Farbabweichungen auftreten. Due to different production methods used in manufacturing tiles and mouldings there is the possibility that slight colour variations may occur.</p>			
10 x 15 cm	10 x 10 cm	3 x 10 cm	2 x 10 cm
3450	3293	3295	3296
UT01, UT02	UT01, UT02	UT01, UT02	UT01, UT02
Hohlkehlsockel · Cove base	Hohlkehlsockel · Cove base	Aussenecke · Outside corner	Innenecke · Inside corner
Werkmaße · Dimensions (mm) 106 x 147 x 6 mm	106 x 97 x 6 mm	36 x 106 x 6 mm	21 x 106 x 6 mm
Farbe · Colour -	-	-	-
Oberfläche · Finish matt Unifarbene Glasur · matt Plain-coloured glaze	matt Unifarbene Glasur · matt Plain-coloured glaze	matt Unifarbene Glasur · matt Plain-coloured glaze	matt Unifarbene Glasur · matt Plain-coloured glaze
Erzeugnisgruppe Steinzeug glasiert	Steinzeug glasiert	Steinzeug glasiert	Steinzeug glasiert
Material Glazed vitreous	Glazed vitreous	Glazed vitreous	Glazed vitreous
Maßeinheit · Unit of measure m 1,33 kg 6,67 pce	m 1,40 kg 10 pce	pce 0,05 kg 1 pce	pce 0,06 kg 1 pce
Pro Paket · Per box 8,40 m 11,20 kg 56 pce	5 m 7 kg 50 pce	24 pce 1,20 kg 24 pce	20 pce 1,20 kg 20 pce
Pro Palette · Per pallet -	-	-	-
Mindestabgabereinheit · Min. sales unit E (pce)	E (pce)	E (pce)	E (pce)
Berechnungseinheit · Calculation unit Stück · piece	Stück · piece	Stück · piece	Stück · piece
Preisgruppe · Price group E22	E15	E50	E50
<p>Wegen der unterschiedlichen Produktionsverfahren von Fliesen und Formstücken können leichte Farbabweichungen auftreten. Due to different production methods used in manufacturing tiles and mouldings there is the possibility that slight colour variations may occur.</p>			
20 x 20 cm	20 x 20 cm	10 x 10 cm □ 0,09 m ² 297 x 297 mm	10 x 10 cm □ 0,09 m ² 297 x 297 mm
2248	2248	2200	2200
UT41	UT42	UT41	UT42
Grundfliese · Basic tile	Grundfliese · Basic tile	Grundfliese · Basic tile	Grundfliese · Basic tile
Werkmaße · Dimensions (mm) 197 x 197 x 8,20 mm	197 x 197 x 8,20 mm	97 x 97 x 6 mm	97 x 97 x 6 mm
Farbe · Colour white	grey	white	grey
Oberfläche · Finish matt VilbostonePlus	matt VilbostonePlus	matt VilbostonePlus	matt VilbostonePlus
Erzeugnisgruppe Feinsteinzeug	Feinsteinzeug	Feinsteinzeug	Feinsteinzeug
Material Porcelain stoneware	Porcelain stoneware	Porcelain stoneware	Porcelain stoneware
Maßeinheit · Unit of measure m ² 17,75 kg 25 pce	m ² 17,75 kg 25 pce	m ² 12,54 kg 11 pce	m ² 12,54 kg 11 pce
Pro Paket · Per box 1,20 m ² 21,30 kg 30 pce	1,20 m ² 21,30 kg 30 pce	1 m ² 12,54 kg 11 pce	1 m ² 12,54 kg 11 pce
Pro Palette · Per pallet 60 m ² 1065 kg 50 box	60 m ² 1065 kg 50 box	78 m ² 978,12 kg 78 box	78 m ² 978,12 kg 78 box
Mindestabgabereinheit · Min. sales unit P (box)	P (box)	P (box)	P (box)
Berechnungseinheit · Calculation unit m ²	m ²	m ²	m ²
Preisgruppe · Price group P91	P91	P98	P98

UNIT ONE

Architektur Design (Basis) · Architecture Design (Basis)

	5 x 5 cm □ 0,09 m ² 297 x 297 mm	5 x 5 cm □ 0,09 m ² 297 x 297 mm	10 x 20 cm	10 x 10 cm
Artikelnummer · Article number	2706	2706	2495	2072
Warengruppe · Product group	UT41	UT42	UT41, UT42	UT41, UT42
Werkmaße · Dimensions (mm)	Grundfliese · Basic tile 48 x 48 x 6 mm	Grundfliese · Basic tile 48 x 48 x 6 mm	Hohlkehlsockel · Cove base 108,20 x 197 x 8,20 mm	Hohlkehlsockel · Cove base 106 x 97 x 6 mm
Farbe · Colour	white	grey	-	-
Oberfläche · Finish	matt VilbostonePlus	matt VilbostonePlus	matt VilbostonePlus	matt VilbostonePlus
Erzeugnisgruppe	Feinsteinzeug	Feinsteinzeug	Feinsteinzeug	Feinsteinzeug
Material	Porcelain stoneware	Porcelain stoneware	Porcelain stoneware	Porcelain stoneware
Maßeinheit · Unit of measure	m ² 11,77 kg 11 pce	m ² 11,77 kg 11 pce	m 1,90 kg 5 pce	m 1,50 kg 10 pce
Pro Paket · Per box	1 m ² 11,77 kg 11 pce	1 m ² 11,77 kg 11 pce	4 m 7,60 kg 20 pce	5 m 7,50 kg 50 pce
Pro Palette · Per pallet	78 m ² 918,06 kg 78 box	78 m ² 918,06 kg 78 box	-	-
Mindestabgabereinheit · Min. sales unit	P (box)	P (box)	E (pce)	E (pce)
Berechnungseinheit · Calculation unit	m ²	m ²	Stück · piece	Stück · piece
Preisgruppe · Price group	P105	P105	E27	E14
	2 x 10 cm	3 x 10 cm		
Artikelnummer · Article number	2073	2074		
Warengruppe · Product group	UT41, UT42	UT41, UT42		
Werkmaße · Dimensions (mm)	Innenecke · Inside corner 21 x 106 x 6 mm	Aussenecke · Outside corner 36 x 106 x 6 mm		
Farbe · Colour	-	-		
Oberfläche · Finish	matt VilbostonePlus	matt VilbostonePlus		
Erzeugnisgruppe	Feinsteinzeug	Feinsteinzeug		
Material	Porcelain stoneware	Porcelain stoneware		
Maßeinheit · Unit of measure	pce 0,08 kg 1 pce	pce 0,10 kg 1 pce		
Pro Paket · Per box	20 pce 1,60 kg 20 pce	24 pce 2,40 kg 24 pce		
Pro Palette · Per pallet	-	-		
Mindestabgabereinheit · Min. sales unit	E (pce)	E (pce)		
Berechnungseinheit · Calculation unit	Stück · piece	Stück · piece		
Preisgruppe · Price group	E33	E33		

UNIT TWO

Architektur Design (Basis) · Architecture Design (Basis)

	30 x 60 cm	30 x 60 cm	20 x 60 cm	20 x 60 cm
Artikelnummer · Article number	1571	1571	1260	1260
Warengruppe · Product group	TW01	TW02	TW01	TW02
Werkmaße · Dimensions (mm)	Grundfliese · Basic tile 297 x 597 x 9 mm	Grundfliese · Basic tile 297 x 597 x 9 mm	Grundfliese · Basic tile 197 x 597 x 9 mm	Grundfliese · Basic tile 197 x 597 x 9 mm
Farbe · Colour	weiß · white	weiß · white	weiß · white	weiß · white
Oberfläche · Finish	matt Unifarbene Glasur · matt Plain-coloured glaze	glänzend Unifarbene Glasur · glossy Plain-coloured glaze	matt Unifarbene Glasur · matt Plain-coloured glaze	glänzend Unifarbene Glasur · glossy Plain-coloured glaze
Erzeugnisgruppe	Steingut	Steingut	Steingut	Steingut
Material	Nonvitreous	Nonvitreous	Nonvitreous	Nonvitreous
Maßeinheit · Unit of measure	m ² 15,56 kg 5,56 pce	m ² 15,56 kg 5,56 pce	m ² 15,42 kg 8,33 pce	m ² 15,42 kg 8,33 pce
Pro Paket · Per box	1,08 m ² 16,80 kg 6 pce	1,08 m ² 16,80 kg 6 pce	1,08 m ² 16,65 kg 9 pce	1,08 m ² 16,65 kg 9 pce
Pro Palette · Per pallet	51,84 m ² 806,40 kg 48 box	51,84 m ² 806,40 kg 48 box	69,12 m ² 1065,60 kg 64 box	69,12 m ² 1065,60 kg 64 box
Mindestabgabereinheit · Min. sales unit	P (box)	P (box)	P (box)	P (box)
Berechnungseinheit · Calculation unit	m ²	m ²	m ²	m ²
Preisgruppe · Price group	P69	P69	P77	P77
	Die matten Fliesen sind reflexionsfrei und daher für Operationsräume geeignet. The matt tiles are non-reflecting and suitable for use in operating theatres.		Die matten Fliesen sind reflexionsfrei und daher für Operationsräume geeignet. The matt tiles are non-reflecting and suitable for use in operating theatres.	

UNIT TWO

Architektur Design (Basis) · Architecture Design (Basis)

	20 x 60 cm	20 x 60 cm	25 x 50 cm	25 x 50 cm
Artikelnummer · Article number	1260	1260	1560	1560
	TW03	TW04	TW01	TW02
Warengruppe · Product group	Grundfliese · Basic tile	Grundfliese · Basic tile	Grundfliese · Basic tile	Grundfliese · Basic tile
Werksmaße · Dimensions (mm)	197 x 597 x 9 mm	197 x 597 x 9 mm	247 x 497 x 7,50 mm	247 x 497 x 7,50 mm
Farbe · Colour	creme	creme	weiß · white	weiß · white
Oberfläche · Finish	glänzend Unifarbene Glasur · glossy Plain-coloured glaze	matt Unifarbene Glasur · matt Plain-coloured glaze	matt Unifarbene Glasur · matt Plain-coloured glaze	glänzend Unifarbene Glasur · glossy Plain-coloured glaze
Erzeugnisgruppe	Steingut	Steingut	Steingut	Steingut
Material	Nonvitreous	Nonvitreous	Nonvitreous	Nonvitreous
Maßeinheit · Unit of measure	m ² 15,42 kg 8,33 pce	m ² 15,42 kg 8,33 pce	m ² 13,60 kg 8 pce	m ² 13,60 kg 8 pce
Pro Paket · Per box	1,08 m ² 16,65 kg 9 pce	1,08 m ² 16,65 kg 9 pce	1 m ² 13,60 kg 8 pce	1 m ² 13,60 kg 8 pce
Pro Palette · Per pallet	69,12 m ² 1065,60 kg 64 box	69,12 m ² 1065,60 kg 64 box	66 m ² 897,60 kg 66 box	66 m ² 897,60 kg 66 box
Mindestabgabereinheit · Min. sales unit	P (box)	P (box)	P (box)	P (box)
Berechnungseinheit · Calculation unit	m ²	m ²	m ²	m ²
Preisgruppe · Price group	P77	P77	P83	P83
		Die matten Fliesen sind reflexionsfrei und daher für Operationsräume geeignet. The matt tiles are non-reflecting and suitable for use in operating theatres.	Die matten Fliesen sind reflexionsfrei und daher für Operationsräume geeignet. The matt tiles are non-reflecting and suitable for use in operating theatres.	
	25 x 40 cm	25 x 40 cm	20 x 40 cm	20 x 40 cm
Artikelnummer · Article number	1390	1390	1240	1240
	TW01	TW02	TW01	TW02
Warengruppe · Product group	Grundfliese · Basic tile	Grundfliese · Basic tile	Grundfliese · Basic tile	Grundfliese · Basic tile
Werksmaße · Dimensions (mm)	247 x 397 x 8 mm	247 x 397 x 8 mm	197 x 397 x 7 mm	197 x 397 x 7 mm
Farbe · Colour	weiß · white	weiß · white	weiß · white	weiß · white
Oberfläche · Finish	matt Unifarbene Glasur · matt Plain-coloured glaze	glänzend Unifarbene Glasur · glossy Plain-coloured glaze	matt Unifarbene Glasur · matt Plain-coloured glaze	glänzend Unifarbene Glasur · glossy Plain-coloured glaze
Erzeugnisgruppe	Steingut	Steingut	Steingut	Steingut
Material	Nonvitreous	Nonvitreous	Nonvitreous	Nonvitreous
Maßeinheit · Unit of measure	m ² 13,60 kg 10 pce	m ² 13,60 kg 10 pce	m ² 13 kg 12,50 pce	m ² 13 kg 12,50 pce
Pro Paket · Per box	1,10 m ² 14,96 kg 11 pce	1,10 m ² 14,96 kg 11 pce	0,96 m ² 12,48 kg 12 pce	0,96 m ² 12,48 kg 12 pce
Pro Palette · Per pallet	79,20 m ² 1077,12 kg 72 box	79,20 m ² 1077,12 kg 72 box	69,12 m ² 898,56 kg 72 box	69,12 m ² 898,56 kg 72 box
Mindestabgabereinheit · Min. sales unit	P (box)	P (box)	P (box)	P (box)
Berechnungseinheit · Calculation unit	m ²	m ²	m ²	m ²
Preisgruppe · Price group	P70	P70	P70	P70
	Die matten Fliesen sind reflexionsfrei und daher für Operationsräume geeignet. The matt tiles are non-reflecting and suitable for use in operating theatres.		Die matten Fliesen sind reflexionsfrei und daher für Operationsräume geeignet. The matt tiles are non-reflecting and suitable for use in operating theatres.	
	20 x 40 cm	20 x 40 cm	15 x 30 cm	15 x 30 cm
Artikelnummer · Article number	1240	1240	1320	1320
	TW03	TW04	TW01	TW02
Warengruppe · Product group	Grundfliese · Basic tile	Grundfliese · Basic tile	Grundfliese · Basic tile	Grundfliese · Basic tile
Werksmaße · Dimensions (mm)	197 x 397 x 7 mm	197 x 397 x 7 mm	147 x 297 x 7 mm	147 x 297 x 7 mm
Farbe · Colour	creme	creme	weiß · white	weiß · white
Oberfläche · Finish	glänzend Unifarbene Glasur · glossy Plain-coloured glaze	matt Unifarbene Glasur · matt Plain-coloured glaze	matt Unifarbene Glasur · matt Plain-coloured glaze	glänzend Unifarbene Glasur · glossy Plain-coloured glaze
Erzeugnisgruppe	Steingut	Steingut	Steingut	Steingut
Material	Nonvitreous	Nonvitreous	Nonvitreous	Nonvitreous
Maßeinheit · Unit of measure	m ² 13 kg 12,50 pce	m ² 13 kg 12,50 pce	m ² 14,44 kg 22,22 pce	m ² 14,44 kg 22,22 pce
Pro Paket · Per box	0,96 m ² 12,48 kg 12 pce	0,96 m ² 12,48 kg 12 pce	0,99 m ² 14,30 kg 22 pce	0,99 m ² 14,30 kg 22 pce
Pro Palette · Per pallet	69,12 m ² 898,56 kg 72 box	69,12 m ² 898,56 kg 72 box	71,28 m ² 1029,60 kg 72 box	71,28 m ² 1029,60 kg 72 box
Mindestabgabereinheit · Min. sales unit	P (box)	P (box)	P (box)	P (box)
Berechnungseinheit · Calculation unit	m ²	m ²	m ²	m ²
Preisgruppe · Price group	P70	P70	P63	P63
		Die matten Fliesen sind reflexionsfrei und daher für Operationsräume geeignet. The matt tiles are non-reflecting and suitable for use in operating theatres.	Die matten Fliesen sind reflexionsfrei und daher für Operationsräume geeignet. The matt tiles are non-reflecting and suitable for use in operating theatres.	

UNIT TWO

Architektur Design (Basis) · Architecture Design (Basis)

	20 x 25 cm		1330		20 x 25 cm		1330		20 x 20 cm		1171		20 x 20 cm		1171
Artikelnummer · Article number	TW01			TW02				TW01				TW02			
Warengruppe · Product group	Grundfliese · Basic tile			Grundfliese · Basic tile				Grundfliese · Basic tile				Grundfliese · Basic tile			
Werkmaße · Dimensions (mm)	197 x 247 x 6,50 mm			197 x 247 x 6,50 mm				197 x 197 x 6 mm				197 x 197 x 6 mm			
Farbe · Colour	weiß · white			weiß · white				weiß · white				weiß · white			
Oberfläche · Finish	matt Unifarbene Glasur · matt Plain-coloured glaze			glänzend Unifarbene Glasur · glossy Plain-coloured glaze				matt Unifarbene Glasur · matt Plain-coloured glaze				glänzend Unifarbene Glasur · glossy Plain-coloured glaze			
Erzeugnisgruppe	Steingut			Steingut				Steingut				Steingut			
Material	Nonvitreous			Nonvitreous				Nonvitreous				Nonvitreous			
Maßeinheit · Unit of measure	m ² 10,80 kg 20 pce			m ² 10,80 kg 20 pce				m ² 10,75 kg 25 pce				m ² 10,75 kg 25 pce			
Pro Paket · Per box	1 m ² 10,80 kg 20 pce			1 m ² 10,80 kg 20 pce				1,20 m ² 12,90 kg 30 pce				1,20 m ² 12,90 kg 30 pce			
Pro Palette · Per pallet	76 m ² 820,80 kg 76 box			76 m ² 820,80 kg 76 box				96 m ² 1032 kg 80 box				96 m ² 1032 kg 80 box			
Mindestabgabereinheit · Min. sales unit	P (box)			P (box)				P (box)				P (box)			
Berechnungseinheit · Calculation unit	m ²			m ²				m ²				m ²			
Preisgruppe · Price group	P66			P66				P61				P61			
	Die matten Fliesen sind reflexionsfrei und daher für Operationsräume geeignet. The matt tiles are non-reflecting and suitable for use in operating theatres.								Die matten Fliesen sind reflexionsfrei und daher für Operationsräume geeignet. The matt tiles are non-reflecting and suitable for use in operating theatres.						
	20 x 20 cm		1171		20 x 20 cm		1171		15 x 20 cm		1315		15 x 20 cm		1315
Artikelnummer · Article number	TW03			TW04				TW01				TW02			
Warengruppe · Product group	Grundfliese · Basic tile			Grundfliese · Basic tile				Grundfliese · Basic tile				Grundfliese · Basic tile			
Werkmaße · Dimensions (mm)	197 x 197 x 6 mm			197 x 197 x 6 mm				147 x 197 x 6 mm				147 x 197 x 6 mm			
Farbe · Colour	creme			creme				weiß · white				weiß · white			
Oberfläche · Finish	glänzend Unifarbene Glasur · glossy Plain-coloured glaze			matt Unifarbene Glasur · matt Plain-coloured glaze				matt Unifarbene Glasur · matt Plain-coloured glaze				glänzend Unifarbene Glasur · glossy Plain-coloured glaze			
Erzeugnisgruppe	Steingut			Steingut				Steingut				Steingut			
Material	Nonvitreous			Nonvitreous				Nonvitreous				Nonvitreous			
Maßeinheit · Unit of measure	m ² 10,75 kg 25 pce			m ² 10,75 kg 25 pce				m ² 10,56 kg 33 pce				m ² 10,56 kg 33 pce			
Pro Paket · Per box	1,20 m ² 12,90 kg 30 pce			1,20 m ² 12,90 kg 30 pce				1 m ² 10,56 kg 33 pce				1 m ² 10,56 kg 33 pce			
Pro Palette · Per pallet	96 m ² 1032 kg 80 box			96 m ² 1032 kg 80 box				96 m ² 1013,76 kg 96 box				96 m ² 1013,76 kg 96 box			
Mindestabgabereinheit · Min. sales unit	P (box)			P (box)				P (box)				P (box)			
Berechnungseinheit · Calculation unit	m ²			m ²				m ²				m ²			
Preisgruppe · Price group	P61			P61				P56				P56			
					Die matten Fliesen sind reflexionsfrei und daher für Operationsräume geeignet. The matt tiles are non-reflecting and suitable for use in operating theatres.				Die matten Fliesen sind reflexionsfrei und daher für Operationsräume geeignet. The matt tiles are non-reflecting and suitable for use in operating theatres.						
	15 x 15 cm		1106		15 x 15 cm		1106		15 x 15 cm		1106		15 x 15 cm		1106
Artikelnummer · Article number	TW01			TW02				TW03				TW04			
Warengruppe · Product group	Grundfliese · Basic tile			Grundfliese · Basic tile				Grundfliese · Basic tile				Grundfliese · Basic tile			
Werkmaße · Dimensions (mm)	147 x 147 x 6 mm			147 x 147 x 6 mm				147 x 147 x 6 mm				147 x 147 x 6 mm			
Farbe · Colour	weiß · white			weiß · white				creme				creme			
Oberfläche · Finish	matt Unifarbene Glasur · matt Plain-coloured glaze			glänzend Unifarbene Glasur · glossy Plain-coloured glaze				glänzend Unifarbene Glasur · glossy Plain-coloured glaze				matt Unifarbene Glasur · matt Plain-coloured glaze			
Erzeugnisgruppe	Steingut			Steingut				Steingut				Steingut			
Material	Nonvitreous			Nonvitreous				Nonvitreous				Nonvitreous			
Maßeinheit · Unit of measure	m ² 10,12 kg 44 pce			m ² 10,12 kg 44 pce				m ² 10,12 kg 44 pce				m ² 10,12 kg 44 pce			
Pro Paket · Per box	1 m ² 10,12 kg 44 pce			1 m ² 10,12 kg 44 pce				1 m ² 10,12 kg 44 pce				1 m ² 10,12 kg 44 pce			
Pro Palette · Per pallet	100 m ² 1012 kg 100 box			100 m ² 1012 kg 100 box				100 m ² 1012 kg 100 box				100 m ² 1012 kg 100 box			
Mindestabgabereinheit · Min. sales unit	P (box)			P (box)				P (box)				P (box)			
Berechnungseinheit · Calculation unit	m ²			m ²				m ²				m ²			
Preisgruppe · Price group	P51			P51				P51				P51			
	Die matten Fliesen sind reflexionsfrei und daher für Operationsräume geeignet. The matt tiles are non-reflecting and suitable for use in operating theatres.								Die matten Fliesen sind reflexionsfrei und daher für Operationsräume geeignet. The matt tiles are non-reflecting and suitable for use in operating theatres.						

UNIT THREE Architektur Design (Basis) · Architecture Design (Basis)

30 x 60 cm	30 x 60 cm	30 x 60 cm	30 x 30 cm
2216	2216	2216	2007
GT20	GT30	GT50	GT10
Grundfliese · Basic tile	Grundfliese · Basic tile	Grundfliese · Basic tile	Grundfliese · Basic tile
Werkmaße · Dimensions (mm) 296 x 596 x 9 mm	Werkmaße · Dimensions (mm) 296 x 596 x 9 mm	Werkmaße · Dimensions (mm) 296 x 596 x 9 mm	Werkmaße · Dimensions (mm) 296 x 296 x 8,20 mm
Farbe · Colour grigio sardo	Farbe · Colour malaga	Farbe · Colour graphit · graphite	Farbe · Colour mondariz
Oberfläche · Finish matt Feinkörnige Granitstruktur · matt Fine-grained granite structure	Oberfläche · Finish matt Feinkörnige Granitstruktur · matt Fine-grained granite structure	Oberfläche · Finish matt Feinkörnige Granitstruktur · matt Fine-grained granite structure	Oberfläche · Finish matt Feinkörnige Granitstruktur · matt Fine-grained granite structure
Erzeugnisgruppe VilbostonePlus	Erzeugnisgruppe VilbostonePlus	Erzeugnisgruppe VilbostonePlus	Erzeugnisgruppe VilbostonePlus
Material Feinsteinzeug	Material Feinsteinzeug	Material Feinsteinzeug	Material Feinsteinzeug
Maßeinheit · Unit of measure Porcelain stoneware	Maßeinheit · Unit of measure Porcelain stoneware	Maßeinheit · Unit of measure Porcelain stoneware	Maßeinheit · Unit of measure Porcelain stoneware
Pro Paket · Per box m ² 18,89 kg 5,56 pce	Pro Paket · Per box m ² 18,89 kg 5,56 pce	Pro Paket · Per box m ² 18,89 kg 5,56 pce	Pro Paket · Per box m ² 17,38 kg 11 pce
Pro Palette · Per pallet 1,08 m ² 20,40 kg 6 pce	Pro Palette · Per pallet 1,08 m ² 20,40 kg 6 pce	Pro Palette · Per pallet 1,08 m ² 20,40 kg 6 pce	Pro Palette · Per pallet 1 m ² 17,38 kg 11 pce
Mindestabgabeneinheit · Min. sales unit 43,20 m ² 816 kg 40 box	Mindestabgabeneinheit · Min. sales unit 43,20 m ² 816 kg 40 box	Mindestabgabeneinheit · Min. sales unit 43,20 m ² 816 kg 40 box	Mindestabgabeneinheit · Min. sales unit 60 m ² 1042,80 kg 60 box
Berechnungseinheit · Calculation unit P (box)	Berechnungseinheit · Calculation unit P (box)	Berechnungseinheit · Calculation unit P (box)	Berechnungseinheit · Calculation unit P (box)
Berechnungseinheit · Calculation unit m ²	Berechnungseinheit · Calculation unit m ²	Berechnungseinheit · Calculation unit m ²	Berechnungseinheit · Calculation unit m ²
Preisgruppe · Price group P87	Preisgruppe · Price group P87	Preisgruppe · Price group P87	Preisgruppe · Price group P82
30 x 30 cm	30 x 30 cm	30 x 30 cm	30 x 30 cm
2007	2007	2007	2118
GT20	GT30	GT50	GT20, GT30, GT50
Grundfliese · Basic tile	Grundfliese · Basic tile	Grundfliese · Basic tile	Grundfliese · Basic tile
Werkmaße · Dimensions (mm) 296 x 296 x 8,20 mm	Werkmaße · Dimensions (mm) 296 x 296 x 8,20 mm	Werkmaße · Dimensions (mm) 296 x 296 x 8,20 mm	Werkmaße · Dimensions (mm) 296 x 296 x 8,20 mm
Farbe · Colour grigio sardo	Farbe · Colour malaga	Farbe · Colour graphit · graphite	Farbe · Colour -
Oberfläche · Finish matt Feinkörnige Granitstruktur · matt Fine-grained granite structure	Oberfläche · Finish matt Feinkörnige Granitstruktur · matt Fine-grained granite structure	Oberfläche · Finish matt Feinkörnige Granitstruktur · matt Fine-grained granite structure	Oberfläche · Finish matt Feinkörnige Granitstruktur · matt Fine-grained granite structure
Erzeugnisgruppe VilbostonePlus	Erzeugnisgruppe VilbostonePlus	Erzeugnisgruppe VilbostonePlus	Erzeugnisgruppe VilbostonePlus
Material Feinsteinzeug	Material Feinsteinzeug	Material Feinsteinzeug	Material Feinsteinzeug
Maßeinheit · Unit of measure Porcelain stoneware	Maßeinheit · Unit of measure Porcelain stoneware	Maßeinheit · Unit of measure Porcelain stoneware	Maßeinheit · Unit of measure Porcelain stoneware
Pro Paket · Per box m ² 17,38 kg 11 pce	Pro Paket · Per box m ² 17,38 kg 11 pce	Pro Paket · Per box m ² 17,38 kg 11 pce	Pro Paket · Per box m ² 17,60 kg 11 pce
Pro Palette · Per pallet 1 m ² 17,38 kg 11 pce	Pro Palette · Per pallet 1 m ² 17,38 kg 11 pce	Pro Palette · Per pallet 1 m ² 17,38 kg 11 pce	Pro Palette · Per pallet 1 m ² 17,60 kg 11 pce
Mindestabgabeneinheit · Min. sales unit 60 m ² 1042,80 kg 60 box	Mindestabgabeneinheit · Min. sales unit 60 m ² 1042,80 kg 60 box	Mindestabgabeneinheit · Min. sales unit 60 m ² 1042,80 kg 60 box	Mindestabgabeneinheit · Min. sales unit 60 m ² 1056 kg 60 box
Berechnungseinheit · Calculation unit P (box)	Berechnungseinheit · Calculation unit P (box)	Berechnungseinheit · Calculation unit P (box)	Berechnungseinheit · Calculation unit P (box)
Berechnungseinheit · Calculation unit m ²	Berechnungseinheit · Calculation unit m ²	Berechnungseinheit · Calculation unit m ²	Berechnungseinheit · Calculation unit m ²
Preisgruppe · Price group P70	Preisgruppe · Price group P70	Preisgruppe · Price group P70	Preisgruppe · Price group P79
30 x 30 cm	30 x 30 cm	30 x 30 cm	30 x 30 cm
2010	2010	2010	2010
GK10	GK20	GK30	GK50
Grundfliese · Basic tile	Grundfliese · Basic tile	Grundfliese · Basic tile	Grundfliese · Basic tile
Werkmaße · Dimensions (mm) 296 x 296 x 8,20 mm	Werkmaße · Dimensions (mm) 296 x 296 x 8,20 mm	Werkmaße · Dimensions (mm) 296 x 296 x 8,20 mm	Werkmaße · Dimensions (mm) 296 x 296 x 8,20 mm
Farbe · Colour mondariz	Farbe · Colour grigio sardo	Farbe · Colour malaga	Farbe · Colour graphit · graphite
Oberfläche · Finish matt Grobkörnige Granitstruktur · matt Coarse-grained granite structure	Oberfläche · Finish matt Grobkörnige Granitstruktur · matt Coarse-grained granite structure	Oberfläche · Finish matt Grobkörnige Granitstruktur · matt Coarse-grained granite structure	Oberfläche · Finish matt Grobkörnige Granitstruktur · matt Coarse-grained granite structure
Erzeugnisgruppe VilbostonePlus	Erzeugnisgruppe VilbostonePlus	Erzeugnisgruppe VilbostonePlus	Erzeugnisgruppe VilbostonePlus
Material Feinsteinzeug	Material Feinsteinzeug	Material Feinsteinzeug	Material Feinsteinzeug
Maßeinheit · Unit of measure Porcelain stoneware	Maßeinheit · Unit of measure Porcelain stoneware	Maßeinheit · Unit of measure Porcelain stoneware	Maßeinheit · Unit of measure Porcelain stoneware
Pro Paket · Per box m ² 17,38 kg 11 pce	Pro Paket · Per box m ² 17,38 kg 11 pce	Pro Paket · Per box m ² 17,38 kg 11 pce	Pro Paket · Per box m ² 17,38 kg 11 pce
Pro Palette · Per pallet 1 m ² 17,38 kg 11 pce	Pro Palette · Per pallet 1 m ² 17,38 kg 11 pce	Pro Palette · Per pallet 1 m ² 17,38 kg 11 pce	Pro Palette · Per pallet 1 m ² 17,38 kg 11 pce
Mindestabgabeneinheit · Min. sales unit 60 m ² 1042,80 kg 60 box	Mindestabgabeneinheit · Min. sales unit 60 m ² 1042,80 kg 60 box	Mindestabgabeneinheit · Min. sales unit 60 m ² 1042,80 kg 60 box	Mindestabgabeneinheit · Min. sales unit 60 m ² 1042,80 kg 60 box
Berechnungseinheit · Calculation unit P (box)	Berechnungseinheit · Calculation unit P (box)	Berechnungseinheit · Calculation unit P (box)	Berechnungseinheit · Calculation unit P (box)
Berechnungseinheit · Calculation unit m ²	Berechnungseinheit · Calculation unit m ²	Berechnungseinheit · Calculation unit m ²	Berechnungseinheit · Calculation unit m ²
Preisgruppe · Price group P95	Preisgruppe · Price group P95	Preisgruppe · Price group P95	Preisgruppe · Price group P95

UNIT THREE Architektur Design (Basis) · Architecture Design (Basis)











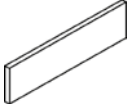





















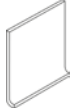

	20 x 20 cm	20 x 20 cm	20 x 20 cm	20 x 20 cm
Artikelnummer · Article number	2001	2001	2001	2001
Warengruppe · Product group	GT10	GT20	GT30	GT50
Werksmaße · Dimensions (mm)	Grundfliese · Basic tile 196 x 196 x 8,20 mm	Grundfliese · Basic tile 196 x 196 x 8,20 mm	Grundfliese · Basic tile 196 x 196 x 8,20 mm	Grundfliese · Basic tile 196 x 196 x 8,20 mm
Farbe · Colour	mondariz	grigio sardo	malaga	graphit · graphite
Oberfläche · Finish	matt Feinkörnige Granitstruktur · matt Fine-grained granite structure VilbostonePlus	matt Feinkörnige Granitstruktur · matt Fine-grained granite structure VilbostonePlus	matt Feinkörnige Granitstruktur · matt Fine-grained granite structure VilbostonePlus	matt Feinkörnige Granitstruktur · matt Fine-grained granite structure VilbostonePlus
Erzeugnisgruppe	Feinsteinzeug	Feinsteinzeug	Feinsteinzeug	Feinsteinzeug
Material	Porcelain stoneware	Porcelain stoneware	Porcelain stoneware	Porcelain stoneware
Maßeinheit · Unit of measure	m ² 17,50 kg 25 pce	m ² 17,50 kg 25 pce	m ² 17,50 kg 25 pce	m ² 17,50 kg 25 pce
Pro Paket · Per box	1,20 m ² 21 kg 30 pce	1,20 m ² 21 kg 30 pce	1,20 m ² 21 kg 30 pce	1,20 m ² 21 kg 30 pce
Pro Palette · Per pallet	60 m ² 1050 kg 50 box	60 m ² 1050 kg 50 box	60 m ² 1050 kg 50 box	60 m ² 1050 kg 50 box
Mindestabgabereinheit · Min. sales unit	P (box)	P (box)	P (box)	P (box)
Berechnungseinheit · Calculation unit	m ²	m ²	m ²	m ²
Preisgruppe · Price group	P89	P76	P76	P76
	20 x 20 cm	20 x 20 cm	20 x 20 cm	20 x 20 cm
Artikelnummer · Article number	2020	2121	2122	2125
Warengruppe · Product group	GT50	GT20, GT30, GT50	GT20, GT30, GT50	GT50
Werksmaße · Dimensions (mm)	Grundfliese · Basic tile 196 x 196 x 13 mm	Grundfliese · Basic tile 196 x 196 x 8,20 mm	Grundfliese · Basic tile 196 x 196 x 8,20 mm	Grundfliese · Basic tile 196 x 196 x 13 mm
Farbe · Colour	graphit · graphite	-	-	graphite
Oberfläche · Finish	matt Feinkörnige Granitstruktur · matt Fine-grained granite structure VilbostonePlus	matt Feinkörnige Granitstruktur · matt Fine-grained granite structure VilbostonePlus	matt Feinkörnige Granitstruktur · matt Fine-grained granite structure VilbostonePlus	matt Granitstruktur reliefiert · matt granite structure relief VilbostonePlus
Erzeugnisgruppe	Feinsteinzeug	Feinsteinzeug	Feinsteinzeug	Feinsteinzeug
Material	Porcelain stoneware	Porcelain stoneware	Porcelain stoneware	Porcelain stoneware
Maßeinheit · Unit of measure	m ² 27,50 kg 25 pce	m ² 17,50 kg 25 pce	m ² 17,50 kg 25 pce	m ² 27,50 kg 25 pce
Pro Paket · Per box	0,60 m ² 16,50 kg 15 pce	1,20 m ² 21 kg 30 pce	1,20 m ² 21 kg 30 pce	0,60 m ² 16,50 kg 15 pce
Pro Palette · Per pallet	36 m ² 990 kg 60 box	60 m ² 1050 kg 50 box	60 m ² 1050 kg 50 box	36 m ² 990 kg 60 box
Mindestabgabereinheit · Min. sales unit	P (box)	P (box)	P (box)	P (box)
Berechnungseinheit · Calculation unit	m ²	m ²	m ²	m ²
Preisgruppe · Price group	P91	P88	P88	P101
	20 x 20 cm	20 x 20 cm	15 x 15 cm	15 x 15 cm
Artikelnummer · Article number	2003	2127	2011	2011
Warengruppe · Product group	GT20, GT30, GT50	GT22	GT20	GT30
Werksmaße · Dimensions (mm)	Grundfliese · Basic tile 196 x 196 x 8,20 mm	Grundfliese · Basic tile 196 x 196 x 12 mm	Grundfliese · Basic tile 146 x 146 x 8,20 mm	Grundfliese · Basic tile 146 x 146 x 8,20 mm
Farbe · Colour	-	grigio sardo uni	grigio sardo	malaga
Oberfläche · Finish	matt Feinkörnige Granitstruktur reliefiert · matt Fine-grained granite structure relief VilbostonePlus	matt reliefiert · matt relief VilbostonePlus	matt Feinkörnige Granitstruktur · matt Fine-grained granite structure VilbostonePlus	matt Feinkörnige Granitstruktur · matt Fine-grained granite structure VilbostonePlus
Erzeugnisgruppe	Feinsteinzeug	Feinsteinzeug	Feinsteinzeug	Feinsteinzeug
Material	Porcelain stoneware	Porcelain stoneware	Porcelain stoneware	Porcelain stoneware
Maßeinheit · Unit of measure	m ² 17,50 kg 25 pce	m ² 25,50 kg 25 pce	m ² 17,16 kg 44 pce	m ² 17,16 kg 44 pce
Pro Paket · Per box	1,20 m ² 21 kg 30 pce	0,64 m ² 16,32 kg 16 pce	0,75 m ² 12,87 kg 33 pce	0,75 m ² 12,87 kg 33 pce
Pro Palette · Per pallet	60 m ² 1050 kg 50 box	38,40 m ² 979,20 kg 60 box	60 m ² 1029,60 kg 80 box	60 m ² 1029,60 kg 80 box
Mindestabgabereinheit · Min. sales unit	P (box)	P (box)	P (box)	P (box)
Berechnungseinheit · Calculation unit	m ²	m ²	m ²	m ²
Preisgruppe · Price group	P88	P109	P92	P92

UNIT THREE Architektur Design (Basis) · Architecture Design (Basis)

































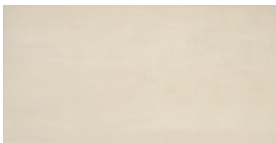







	15 x 15 cm	15 x 15 cm	15 x 15 cm	15 x 15 cm
Artikelnummer · Article number	2011	2119	2120	2219
Warengruppe · Product group	GT50	GT20, GT30, GT50	GT20, GT30, GT50	GT20, GT30, GT50
Werksmaße · Dimensions (mm)	146 x 146 x 8,20 mm	146 x 146 x 8,20 mm	146 x 146 x 8,20 mm	146 x 146 x 8,20 mm
Farbe · Colour	graphit · graphite	-	-	-
Oberfläche · Finish	matt Feinkörnige Granitstruktur · matt Fine-grained granite structure VilbostonePlus	matt Feinkörnige Granitstruktur · matt Fine-grained granite structure VilbostonePlus	matt Feinkörnige Granitstruktur · matt Fine-grained granite structure VilbostonePlus	matt Feinkörnige Granitstruktur reliefiert · matt Fine-grained granite structure relief VilbostonePlus
Erzeugnisgruppe	Feinsteinzeug	Feinsteinzeug	Feinsteinzeug	Feinsteinzeug
Material	Porcelain stoneware	Porcelain stoneware	Porcelain stoneware	Porcelain stoneware
Maßeinheit · Unit of measure	m ² 17,16 kg 44 pce	m ² 17,16 kg 44 pce	m ² 17,16 kg 44 pce	m ² 17,16 kg 44 pce
Pro Paket · Per box	0,75 m ² 12,87 kg 33 pce	0,75 m ² 12,87 kg 33 pce	0,75 m ² 12,87 kg 33 pce	0,75 m ² 12,87 kg 33 pce
Pro Palette · Per pallet	60 m ² 1029,60 kg 80 box	60 m ² 1029,60 kg 80 box	60 m ² 1029,60 kg 80 box	60 m ² 1029,60 kg 80 box
Mindestabgabereinheit · Min. sales unit	P (box)	P (box)	P (box)	P (box)
Berechnungseinheit · Calculation unit	m ²	m ²	m ²	m ²
Preisgruppe · Price group	P92	P97	P97	P97E25
	10 x 10 cm	10 x 10 cm	10 x 10 cm	30 x 30 cm
	□ 0,09 m ² 297 x 297 mm	□ 0,09 m ² 297 x 297 mm	□ 0,09 m ² 297 x 297 mm	
Artikelnummer · Article number	2200	2200	2200	2008
Warengruppe · Product group	GT20	GT30	GT50	GT10, GT20, GT30 GT50
Werksmaße · Dimensions (mm)	97 x 97 x 6 mm	97 x 97 x 6 mm	97 x 97 x 6 mm	296 x 296 x 8,20 mm
Farbe · Colour	grigio sardo	malaga	graphit · graphite	-
Oberfläche · Finish	matt Feinkörnige Granitstruktur · matt Fine-grained granite structure VilbostonePlus	matt Feinkörnige Granitstruktur · matt Fine-grained granite structure VilbostonePlus	matt Feinkörnige Granitstruktur · matt Fine-grained granite structure VilbostonePlus	matt Feinkörnige Granitstruktur · matt Fine-grained granite structure VilbostonePlus
Erzeugnisgruppe	Feinsteinzeug	Feinsteinzeug	Feinsteinzeug	Feinsteinzeug
Material	Porcelain stoneware	Porcelain stoneware	Porcelain stoneware	Porcelain stoneware
Maßeinheit · Unit of measure	m ² 12,54 kg 11 pce	m ² 12,54 kg 11 pce	m ² 12,54 kg 11 pce	m 5,59 kg 3,33 pce
Pro Paket · Per box	1 m ² 12,54 kg 11 pce	1 m ² 12,54 kg 11 pce	1 m ² 12,54 kg 11 pce	3,30 m 18,48 kg 11 pce
Pro Palette · Per pallet	78 m ² 978,12 kg 78 box	78 m ² 978,12 kg 78 box	78 m ² 978,12 kg 78 box	-
Mindestabgabereinheit · Min. sales unit	P (box)	P (box)	P (box)	E (pce)
Berechnungseinheit · Calculation unit	m ²	m ²	m ²	Stück · piece
Preisgruppe · Price group	P95	P95	P95	E45

Auftragsbezogene Fertigung der Treppen in der zu bestellten Grundfliese passenden Nuance. Lieferzeit auf Anfrage.
Steps made to order in the nuance that matches the basic tile ordered. Delivery time on request.











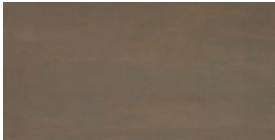



















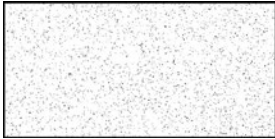



















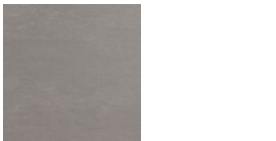
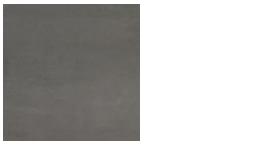







UNIT THREE Architektur Design (Basis) · Architecture Design (Basis)

				
	7,5 x 30 cm	10 x 10 cm	10 x 20 cm	2 x 10 cm
Artikelnummer · Article number	2009	2072	2004	2073
	GT10, GT20, GT30    GT50   	GT20, GT22, GT30    GT50   	GT10, GT20, GT22    GT30, GT50   	GT10, GT20, GT22  GT30, GT50 
Warengruppe · Product group	Sockel · Skirting	Hohlkehlsockel · Cove base	Hohlkehlsockel · Cove base	Innenecke · Inside corner
Werkgröße · Dimensions (mm)	71 x 296 x 8,20 mm	106 x 97 x 6 mm	108,20 x 197 x 8,20 mm	21 x 106 x 6 mm
Farbe · Colour	-	-	-	-
Oberfläche · Finish	matt Feinkörnige Granitstruktur · matt Fine-grained granite structure	matt Feinkörnige Granitstruktur · matt Fine-grained granite structure	matt Feinkörnige Granitstruktur · matt Fine-grained granite structure	matt Feinkörnige Granitstruktur · matt Fine-grained granite structure
Erzeugnisgruppe	VilbostonePlus	VilbostonePlus	VilbostonePlus	VilbostonePlus
Material	Feinsteinzeug	Feinsteinzeug	Feinsteinzeug	Feinsteinzeug
Maßeinheit · Unit of measure	Porcelain stoneware	Porcelain stoneware	Porcelain stoneware	Porcelain stoneware
Pro Paket · Per box	m 1,50 kg 3,33 pce	m 1,50 kg 10 pce	m 2 kg 5 pce	pce 0,08 kg 1 pce
Pro Palette · Per pallet	9,61 m 14,40 kg 32 pce	5 m 7,50 kg 50 pce	4 m 8 kg 20 pce	20 pce 1,60 kg 20 pce
Mindestabgabereinheit · Min. sales unit	-	-	-	-
Berechnungseinheit · Calculation unit	E (pce)	E (pce)	E (pce)	E (pce)
Preisgruppe · Price group	Stück · piece	Stück · piece	Stück · piece	Stück · piece
	E21	E13	E25	E30
				
	3 x 10 cm	15 x 15 cm	2 x 15 cm	3 x 15 cm
Artikelnummer · Article number	2074	2265	2266	2269
	GT10, GT20, GT22  GT30, GT50 	GT20, GT30, GT50   	GT20, GT30, GT50 	GT20, GT30, GT50 
Warengruppe · Product group	Aussenecke · Outside corner	Hohlkehlsockel · Cove base	Innenecke · Inside corner	Aussenecke · Outside corner
Werkgröße · Dimensions (mm)	36 x 106 x 6 mm	158,20 x 146 x 8,20 mm	23 x 158,20 x 8,20 mm	38 x 158,20 x 8,20 mm
Farbe · Colour	-	-	-	-
Oberfläche · Finish	matt Feinkörnige Granitstruktur · matt Fine-grained granite structure	matt Feinkörnige Granitstruktur · matt Fine-grained granite structure	matt Feinkörnige Granitstruktur · matt Fine-grained granite structure	matt Feinkörnige Granitstruktur · matt Fine-grained granite structure
Erzeugnisgruppe	VilbostonePlus	VilbostonePlus	VilbostonePlus	VilbostonePlus
Material	Feinsteinzeug	Feinsteinzeug	Feinsteinzeug	Feinsteinzeug
Maßeinheit · Unit of measure	Porcelain stoneware	Porcelain stoneware	Porcelain stoneware	Porcelain stoneware
Pro Paket · Per box	pce 0,10 kg 1 pce	m 2,80 kg 6,67 pce	pce 0,14 kg 1 pce	pce 0,14 kg 1 pce
Pro Palette · Per pallet	24 pce 2,40 kg 24 pce	4,50 m 12,60 kg 30 pce	20 pce 2,80 kg 20 pce	20 pce 2,80 kg 20 pce
Mindestabgabereinheit · Min. sales unit	-	-	-	-
Berechnungseinheit · Calculation unit	E (pce)	E (pce)	E (pce)	E (pce)
Preisgruppe · Price group	Stück · piece	Stück · piece	Stück · piece	Stück · piece
	E30	E23	E45	E45

UNIT FOUR Architektur Design (Basis) · Architecture Design (Basis)

				
	60 x 60 cm 	60 x 60 cm 	60 x 60 cm 	60 x 60 cm 
Artikelnummer · Article number	2361	2361	2361	2361
	CT10   	CT70   	CT80   	CT60   
Warengruppe · Product group	Grundfliese · Basic tile	Grundfliese · Basic tile	Grundfliese · Basic tile	Grundfliese · Basic tile
Werkmaße · Dimensions (mm)	597 x 597 x 10 mm	597 x 597 x 10 mm	597 x 597 x 10 mm	597 x 597 x 10 mm
Farbe · Colour	creme	greige	dunkelbraun · dark brown	hellgrau · light grey
Oberfläche · Finish	matt Dezent schattierte Keramik · matt Subtly shaded ceramic	matt Dezent schattierte Keramik · matt Subtly shaded ceramic	matt Dezent schattierte Keramik · matt Subtly shaded ceramic	matt Dezent schattierte Keramik · matt Subtly shaded ceramic
Erzeugnisgruppe	Feinsteinzeug	Feinsteinzeug	Feinsteinzeug	Feinsteinzeug
Material	Porcelain stoneware	Porcelain stoneware	Porcelain stoneware	Porcelain stoneware
Maßeinheit · Unit of measure	m ² 22,22 kg 2,78 pce	m ² 22,22 kg 2,78 pce	m ² 22,22 kg 2,78 pce	m ² 22,22 kg 2,78 pce
Pro Paket · Per box	1,44 m ² 32 kg 4 pce	1,44 m ² 32 kg 4 pce	1,44 m ² 32 kg 4 pce	1,44 m ² 32 kg 4 pce
Pro Palette · Per pallet	43,20 m ² 960 kg 30 box	43,20 m ² 960 kg 30 box	43,20 m ² 960 kg 30 box	43,20 m ² 960 kg 30 box
Mindestabgabereinheit · Min. sales unit	P (box)	P (box)	P (box)	P (box)
Berechnungseinheit · Calculation unit	m ²	m ²	m ²	m ²
Preisgruppe · Price group	P83	P83	P83	P83
				
	60 x 60 cm 	60 x 60 cm 	30 x 60 cm 	30 x 60 cm 
Artikelnummer · Article number	2361	2361	2360	2360
	CT61   	CT62   	CT10   	CT70   
Warengruppe · Product group	Grundfliese · Basic tile	Grundfliese · Basic tile	Grundfliese · Basic tile	Grundfliese · Basic tile
Werkmaße · Dimensions (mm)	597 x 597 x 10 mm	597 x 597 x 10 mm	297 x 597 x 10 mm	297 x 597 x 10 mm
Farbe · Colour	mittelgrau · medium grey	dunkelgrau · dark grey	creme	greige
Oberfläche · Finish	matt Dezent schattierte Keramik · matt Subtly shaded ceramic	matt Dezent schattierte Keramik · matt Subtly shaded ceramic	matt Dezent schattierte Keramik · matt Subtly shaded ceramic	matt Dezent schattierte Keramik · matt Subtly shaded ceramic
Erzeugnisgruppe	Feinsteinzeug	Feinsteinzeug	Feinsteinzeug	Feinsteinzeug
Material	Porcelain stoneware	Porcelain stoneware	Porcelain stoneware	Porcelain stoneware
Maßeinheit · Unit of measure	m ² 22,22 kg 2,78 pce	m ² 22,22 kg 2,78 pce	m ² 22,22 kg 5,56 pce	m ² 22,22 kg 5,56 pce
Pro Paket · Per box	1,44 m ² 32 kg 4 pce	1,44 m ² 32 kg 4 pce	1,08 m ² 24 kg 6 pce	1,08 m ² 24 kg 6 pce
Pro Palette · Per pallet	43,20 m ² 960 kg 30 box	43,20 m ² 960 kg 30 box	43,20 m ² 960 kg 40 box	43,20 m ² 960 kg 40 box
Mindestabgabereinheit · Min. sales unit	P (box)	P (box)	P (box)	P (box)
Berechnungseinheit · Calculation unit	m ²	m ²	m ²	m ²
Preisgruppe · Price group	P83	P83	P90	P90

UNIT FOUR Architektur Design (Basis) · Architecture Design (Basis)

			
30 x 60 cm	30 x 60 cm	30 x 60 cm	30 x 60 cm
2360	2360	2360	2360
CT80    	CT60    	CT61    	CT62    
Grundfliese · Basic tile	Grundfliese · Basic tile	Grundfliese · Basic tile	Grundfliese · Basic tile
Werkmaße · Dimensions (mm) 297 x 597 x 10 mm	Werkmaße · Dimensions (mm) 297 x 597 x 10 mm	Werkmaße · Dimensions (mm) 297 x 597 x 10 mm	Werkmaße · Dimensions (mm) 297 x 597 x 10 mm
Farbe · Colour dunkelbraun · dark brown	Farbe · Colour hellgrau · light grey	Farbe · Colour mittelgrau · medium grey	Farbe · Colour dunkelgrau · dark grey
Oberfläche · Finish matt Dezent schattierte Keramik · matt Subtly shaded ceramic	Oberfläche · Finish matt Dezent schattierte Keramik · matt Subtly shaded ceramic	Oberfläche · Finish matt Dezent schattierte Keramik · matt Subtly shaded ceramic	Oberfläche · Finish matt Dezent schattierte Keramik · matt Subtly shaded ceramic
Erzeugnisgruppe Feinsteinzeug	Erzeugnisgruppe Feinsteinzeug	Erzeugnisgruppe Feinsteinzeug	Erzeugnisgruppe Feinsteinzeug
Material Porcelain stoneware	Material Porcelain stoneware	Material Porcelain stoneware	Material Porcelain stoneware
Maßeinheit · Unit of measure m ² 22,22 kg 5,56 pce	Maßeinheit · Unit of measure m ² 22,22 kg 5,56 pce	Maßeinheit · Unit of measure m ² 22,22 kg 5,56 pce	Maßeinheit · Unit of measure m ² 22,22 kg 5,56 pce
Pro Paket · Per box 1,08 m ² 24 kg 6 pce	Pro Paket · Per box 1,08 m ² 24 kg 6 pce	Pro Paket · Per box 1,08 m ² 24 kg 6 pce	Pro Paket · Per box 1,08 m ² 24 kg 6 pce
Pro Palette · Per pallet 43,20 m ² 960 kg 40 box	Pro Palette · Per pallet 43,20 m ² 960 kg 40 box	Pro Palette · Per pallet 43,20 m ² 960 kg 40 box	Pro Palette · Per pallet 43,20 m ² 960 kg 40 box
Mindestabgabeneinheit · Min. sales unit P (box)	Mindestabgabeneinheit · Min. sales unit P (box)	Mindestabgabeneinheit · Min. sales unit P (box)	Mindestabgabeneinheit · Min. sales unit P (box)
Berechnungseinheit · Calculation unit m ²	Berechnungseinheit · Calculation unit m ²	Berechnungseinheit · Calculation unit m ²	Berechnungseinheit · Calculation unit m ²
Preisgruppe · Price group P90	Preisgruppe · Price group P90	Preisgruppe · Price group P90	Preisgruppe · Price group P90
			
30 x 60 cm	30 x 30 cm	30 x 30 cm	30 x 30 cm
2680	2369	2369	2369
CT10, CT60, CT61    	CT10   	CT70    	CT80    
Grundfliese · Basic tile	Grundfliese · Basic tile	Grundfliese · Basic tile	Grundfliese · Basic tile
Werkmaße · Dimensions (mm) 297 x 597 x 10 mm	Werkmaße · Dimensions (mm) 296 x 296 x 7,50 mm	Werkmaße · Dimensions (mm) 296 x 296 x 7,50 mm	Werkmaße · Dimensions (mm) 296 x 296 x 7,50 mm
Farbe · Colour -	Farbe · Colour creme	Farbe · Colour greige	Farbe · Colour dunkelbraun · dark brown
Oberfläche · Finish matt Dezent schattierte Keramik reliefriert · matt Subtly shaded ceramic relief	Oberfläche · Finish matt Dezent schattierte Keramik · matt Subtly shaded ceramic	Oberfläche · Finish matt Dezent schattierte Keramik · matt Subtly shaded ceramic	Oberfläche · Finish matt Dezent schattierte Keramik · matt Subtly shaded ceramic
Erzeugnisgruppe Feinsteinzeug	Erzeugnisgruppe Feinsteinzeug glasiert	Erzeugnisgruppe Feinsteinzeug glasiert	Erzeugnisgruppe Feinsteinzeug glasiert
Material Porcelain stoneware	Material Glazed porcelain stoneware	Material Glazed porcelain stoneware	Material Glazed porcelain stoneware
Maßeinheit · Unit of measure m ² 22,22 kg 5,56 pce	Maßeinheit · Unit of measure m ² 14,52 kg 11 pce	Maßeinheit · Unit of measure m ² 14,52 kg 11 pce	Maßeinheit · Unit of measure m ² 14,52 kg 11 pce
Pro Paket · Per box 1,08 m ² 24 kg 6 pce	Pro Paket · Per box 1 m ² 14,52 kg 11 pce	Pro Paket · Per box 1 m ² 14,52 kg 11 pce	Pro Paket · Per box 1 m ² 14,52 kg 11 pce
Pro Palette · Per pallet 43,20 m ² 960 kg 40 box	Pro Palette · Per pallet 60 m ² 871,20 kg 60 box	Pro Palette · Per pallet 60 m ² 871,20 kg 60 box	Pro Palette · Per pallet 60 m ² 871,20 kg 60 box
Mindestabgabeneinheit · Min. sales unit P (box)	Mindestabgabeneinheit · Min. sales unit P (box)	Mindestabgabeneinheit · Min. sales unit P (box)	Mindestabgabeneinheit · Min. sales unit P (box)
Berechnungseinheit · Calculation unit m ²	Berechnungseinheit · Calculation unit m ²	Berechnungseinheit · Calculation unit m ²	Berechnungseinheit · Calculation unit m ²
Preisgruppe · Price group P83	Preisgruppe · Price group P69	Preisgruppe · Price group P69	Preisgruppe · Price group P69
			
30 x 30 cm	30 x 30 cm	30 x 30 cm	5 x 5 cm
2369	2369	2369	2363
CT60    	CT61    	CT62    	CT10    
Grundfliese · Basic tile	Grundfliese · Basic tile	Grundfliese · Basic tile	Grundfliese · Basic tile
Werkmaße · Dimensions (mm) 296 x 296 x 7,50 mm	Werkmaße · Dimensions (mm) 296 x 296 x 7,50 mm	Werkmaße · Dimensions (mm) 296 x 296 x 7,50 mm	Werkmaße · Dimensions (mm) 48 x 48 x 10 mm
Farbe · Colour hellgrau · light grey	Farbe · Colour mittelgrau · medium grey	Farbe · Colour dunkelgrau · dark grey	Farbe · Colour creme
Oberfläche · Finish matt Dezent schattierte Keramik · matt Subtly shaded ceramic	Oberfläche · Finish matt Dezent schattierte Keramik · matt Subtly shaded ceramic	Oberfläche · Finish matt Dezent schattierte Keramik · matt Subtly shaded ceramic	Oberfläche · Finish matt Dezent schattierte Keramik · matt Subtly shaded ceramic
Erzeugnisgruppe Feinsteinzeug glasiert	Erzeugnisgruppe Feinsteinzeug glasiert	Erzeugnisgruppe Feinsteinzeug glasiert	Erzeugnisgruppe Feinsteinzeug
Material Glazed porcelain stoneware	Material Glazed porcelain stoneware	Material Glazed porcelain stoneware	Material Porcelain stoneware
Maßeinheit · Unit of measure m ² 14,52 kg 11 pce	Maßeinheit · Unit of measure m ² 14,52 kg 11 pce	Maßeinheit · Unit of measure m ² 14,52 kg 11 pce	Maßeinheit · Unit of measure m ² 20,90 kg 11 pce
Pro Paket · Per box 1 m ² 14,52 kg 11 pce	Pro Paket · Per box 1 m ² 14,52 kg 11 pce	Pro Paket · Per box 1 m ² 14,52 kg 11 pce	Pro Paket · Per box 1 m ² 20,90 kg 11 pce
Pro Palette · Per pallet 60 m ² 871,20 kg 60 box	Pro Palette · Per pallet 60 m ² 871,20 kg 60 box	Pro Palette · Per pallet 60 m ² 871,20 kg 60 box	Pro Palette · Per pallet 36 m ² 752,40 kg 36 box
Mindestabgabeneinheit · Min. sales unit P (box)	Mindestabgabeneinheit · Min. sales unit P (box)	Mindestabgabeneinheit · Min. sales unit P (box)	Mindestabgabeneinheit · Min. sales unit P (box)
Berechnungseinheit · Calculation unit m ²	Berechnungseinheit · Calculation unit m ²	Berechnungseinheit · Calculation unit m ²	Berechnungseinheit · Calculation unit m ²
Preisgruppe · Price group P69	Preisgruppe · Price group P69	Preisgruppe · Price group P69	Preisgruppe · Price group P171
<input type="checkbox"/> 0,09 m ² 298 x 298 mm			

UNIT FOUR Architektur Design (Basis) · Architecture Design (Basis)

	5 x 5 cm	5 x 5 cm	5 x 5 cm	5 x 5 cm
	□ 0,09 m ² 298 x 298 mm	□ 0,09 m ² 298 x 298 mm	□ 0,09 m ² 298 x 298 mm	□ 0,09 m ² 298 x 298 mm
Artikelnummer · Article number	2363	2363	2363	2363
Warengruppe · Product group	CT70	CT80	CT60	CT61
Werksmaße · Dimensions (mm)	Grundfliese · Basic tile 48 x 48 x 10 mm	Grundfliese · Basic tile 48 x 48 x 10 mm	Grundfliese · Basic tile 48 x 48 x 10 mm	Grundfliese · Basic tile 48 x 48 x 10 mm
Farbe · Colour	greige	dunkelbraun · dark brown	hellgrau · light grey	mittelgrau · medium grey
Oberfläche · Finish	matt Dezent schattierte Keramik · matt Subtly shaded ceramic VilbostonePlus	matt Dezent schattierte Keramik · matt Subtly shaded ceramic VilbostonePlus	matt Dezent schattierte Keramik · matt Subtly shaded ceramic VilbostonePlus	matt Dezent schattierte Keramik · matt Subtly shaded ceramic VilbostonePlus
Erzeugnisgruppe	Feinsteinzeug	Feinsteinzeug	Feinsteinzeug	Feinsteinzeug
Material	Porcelain stoneware	Porcelain stoneware	Porcelain stoneware	Porcelain stoneware
Maßeinheit · Unit of measure	m ² 20,90 kg 11 pce	m ² 20,90 kg 11 pce	m ² 20,90 kg 11 pce	m ² 20,90 kg 11 pce
Pro Paket · Per box	1 m ² 20,90 kg 11 pce	1 m ² 20,90 kg 11 pce	1 m ² 20,90 kg 11 pce	1 m ² 20,90 kg 11 pce
Pro Palette · Per pallet	36 m ² 752,40 kg 36 box	36 m ² 752,40 kg 36 box	36 m ² 752,40 kg 36 box	36 m ² 752,40 kg 36 box
Mindestabgabereinheit · Min. sales unit	P (box)	P (box)	P (box)	P (box)
Berechnungseinheit · Calculation unit	m ²	m ²	m ²	m ²
Preisgruppe · Price group	P171	P171	P171	P171
	5 x 5 cm	5 x 5 cm	5 x 5 cm	5 x 5 cm
	□ 0,09 m ² 298 x 298 mm	□ 0,09 m ² 298 x 298 mm	□ 0,09 m ² 298 x 298 mm	□ 0,09 m ² 298 x 298 mm
Artikelnummer · Article number	2363	2706	2706	2706
Warengruppe · Product group	CT62	CT10	CT70	CT80
Werksmaße · Dimensions (mm)	Grundfliese · Basic tile 48 x 48 x 10 mm	Grundfliese · Basic tile 48 x 48 x 6 mm	Grundfliese · Basic tile 48 x 48 x 6 mm	Grundfliese · Basic tile 48 x 48 x 6 mm
Farbe · Colour	dunkelgrau · dark grey	creme	greige	dunkelbraun · dark brown
Oberfläche · Finish	matt Dezent schattierte Keramik · matt Subtly shaded ceramic VilbostonePlus	matt Dezent schattierte Keramik · matt Subtly shaded ceramic	matt Dezent schattierte Keramik · matt Subtly shaded ceramic	matt Dezent schattierte Keramik · matt Subtly shaded ceramic
Erzeugnisgruppe	Feinsteinzeug	Feinsteinzeug glasiert	Feinsteinzeug glasiert	Feinsteinzeug glasiert
Material	Porcelain stoneware	Glazed porcelain stoneware	Glazed porcelain stoneware	Glazed porcelain stoneware
Maßeinheit · Unit of measure	m ² 20,90 kg 11 pce	m ² 11,77 kg 11 pce	m ² 11,77 kg 11 pce	m ² 11,77 kg 11 pce
Pro Paket · Per box	1 m ² 20,90 kg 11 pce	1 m ² 11,77 kg 11 pce	1 m ² 11,77 kg 11 pce	1 m ² 11,77 kg 11 pce
Pro Palette · Per pallet	36 m ² 752,40 kg 36 box	78 m ² 918,06 kg 78 box	78 m ² 918,06 kg 78 box	78 m ² 918,06 kg 78 box
Mindestabgabereinheit · Min. sales unit	P (box)	P (box)	P (box)	P (box)
Berechnungseinheit · Calculation unit	m ²	m ²	m ²	m ²
Preisgruppe · Price group	P171	P114	P114	P114

UNIT FOUR Architektur Design (Basis) · Architecture Design (Basis)

	5 x 5 cm	5 x 5 cm	5 x 5 cm	30 x 60 cm
	□ 0,09 m ² 298 x 298 mm	□ 0,09 m ² 298 x 298 mm	□ 0,09 m ² 298 x 298 mm	
Artikelnummer · Article number	2706	2706	2706	2874
	CT60	CT61	CT62	CT10, CT60, CT61 CT62, CT70, CT80
Warengruppe · Product group	Grundfliese · Basic tile	Grundfliese · Basic tile	Grundfliese · Basic tile	Treppenauftritt · Stair tread
Werkmaße · Dimensions (mm)	48 x 48 x 6 mm	48 x 48 x 6 mm	48 x 48 x 6 mm	297 x 597 x 10 mm
Farbe · Colour	hellgrau · light grey	mittelgrau · medium grey	dunkelgrau · dark grey	-
Oberfläche · Finish	matt Dezent schattierte Keramik · matt Subtly shaded ceramic	matt Dezent schattierte Keramik · matt Subtly shaded ceramic	matt Dezent schattierte Keramik · matt Subtly shaded ceramic	matt Dezent schattierte Keramik · matt Subtly shaded ceramic
Erzeugnisgruppe	Feinsteinzeug glasiert	Feinsteinzeug glasiert	Feinsteinzeug glasiert	Feinsteinzeug
Material	Glazed porcelain stoneware	Glazed porcelain stoneware	Glazed porcelain stoneware	Porcelain stoneware
Maßeinheit · Unit of measure	m ² 11,77 kg 11 pce	m ² 11,77 kg 11 pce	m ² 11,77 kg 11 pce	m 5,86 kg 1,67 pce
Pro Paket · Per box	1 m ² 11,77 kg 11 pce	1 m ² 11,77 kg 11 pce	1 m ² 11,77 kg 11 pce	3,59 m 21,06 kg 6 pce
Pro Palette · Per pallet	78 m ² 918,06 kg 78 box	78 m ² 918,06 kg 78 box	78 m ² 918,06 kg 78 box	-
Mindestabgabereinheit · Min. sales unit	P (box)	P (box)	P (box)	E (pce)
Berechnungseinheit · Calculation unit	m ²	m ²	m ²	Stück · piece
Preisgruppe · Price group	P114	P114	P114	E87
				Auftragsbezogene Fertigung der Treppen in der zu bestellten Grundfliese passenden Nuance. Lieferzeit auf Anfrage. Steps made to order in the nuance that matches the basic tile ordered. Delivery time on request.
	7,5 x 60 cm			
Artikelnummer · Article number	2873			
	CT10, CT60, CT61 CT62, CT70, CT80			
Warengruppe · Product group	Sockel · Skirting			
Werkmaße · Dimensions (mm)	72 x 597 x 10 mm			
Farbe · Colour	-			
Oberfläche · Finish	matt Dezent schattierte Keramik · matt Subtly shaded ceramic			
Erzeugnisgruppe	Feinsteinzeug			
Material	Porcelain stoneware			
Maßeinheit · Unit of measure	m 1,67 kg 1,67 pce			
Pro Paket · Per box	11,98 m 20 kg 20 pce			
Pro Palette · Per pallet	-			
Mindestabgabereinheit · Min. sales unit	E (pce)			
Berechnungseinheit · Calculation unit	Stück · piece			
Preisgruppe · Price group	E42			

UNIT FOUR WALL

Architektur Design (Basis) · Architecture Design (Basis)

	30 x 60 cm	30 x 60 cm	30 x 60 cm	30 x 60 cm
Artikelnummer · Article number	1599	1599	1590	1590
	CT10	CT60	CT10	CT60
Warengruppe · Product group	Grundfliese · Basic tile	Grundfliese · Basic tile	Grundfliese · Basic tile	Grundfliese · Basic tile
Werkmaße · Dimensions (mm)	297 x 597 x 9 mm	297 x 597 x 9 mm	297 x 597 x 9 mm	297 x 597 x 9 mm
Farbe · Colour	creme	grau · grey	creme	grau · grey
Oberfläche · Finish	matt Dezent schattierte Keramik reliefiert · matt Subtly shaded ceramic relief CeramicPlus	matt Dezent schattierte Keramik reliefiert · matt Subtly shaded ceramic relief CeramicPlus	matt Dezent schattierte Keramik reliefiert · matt Subtly shaded ceramic relief CeramicPlus	matt Dezent schattierte Keramik reliefiert · matt Subtly shaded ceramic relief CeramicPlus
Erzeugnisgruppe	Steingut	Steingut	Steingut	Steingut
Material	Nonvitreous	Nonvitreous	Nonvitreous	Nonvitreous
Maßeinheit · Unit of measure	m ² 15,56 kg 5,56 pce	m ² 15,56 kg 5,56 pce	m ² 15,56 kg 5,56 pce	m ² 15,56 kg 5,56 pce
Pro Paket · Per box	1,08 m ² 16,80 kg 6 pce	1,08 m ² 16,80 kg 6 pce	1,08 m ² 16,80 kg 6 pce	1,08 m ² 16,80 kg 6 pce
Pro Palette · Per pallet	51,84 m ² 806,40 kg 48 box	51,84 m ² 806,40 kg 48 box	51,84 m ² 806,40 kg 48 box	51,84 m ² 806,40 kg 48 box
Mindestabgabeneinheit · Min. sales unit	P (box)	P (box)	P (box)	P (box)
Berechnungseinheit · Calculation unit	m ²	m ²	m ²	m ²
Preisgruppe · Price group	P71	P71	P79	P79
	20 x 60 cm	20 x 60 cm	20 x 40 cm	20 x 40 cm
Artikelnummer · Article number	1600	1600	1241	1241
	CT10	CT60	CT10	CT60
Warengruppe · Product group	Grundfliese · Basic tile	Grundfliese · Basic tile	Grundfliese · Basic tile	Grundfliese · Basic tile
Werkmaße · Dimensions (mm)	197 x 597 x 9 mm	197 x 597 x 9 mm	197 x 397 x 7 mm	197 x 397 x 7 mm
Farbe · Colour	creme	grau · grey	creme	grau · grey
Oberfläche · Finish	matt Dezent schattierte Keramik reliefiert · matt Subtly shaded ceramic relief CeramicPlus	matt Dezent schattierte Keramik reliefiert · matt Subtly shaded ceramic relief CeramicPlus	matt Dezent schattierte Keramik · matt Subtly shaded ceramic CeramicPlus	matt Dezent schattierte Keramik · matt Subtly shaded ceramic CeramicPlus
Erzeugnisgruppe	Steingut	Steingut	Steingut	Steingut
Material	Nonvitreous	Nonvitreous	Nonvitreous	Nonvitreous
Maßeinheit · Unit of measure	m ² 15,42 kg 8,33 pce	m ² 15,42 kg 8,33 pce	m ² 12 kg 12,50 pce	m ² 12 kg 12,50 pce
Pro Paket · Per box	1,08 m ² 16,65 kg 9 pce	1,08 m ² 16,65 kg 9 pce	0,96 m ² 11,52 kg 12 pce	0,96 m ² 11,52 kg 12 pce
Pro Palette · Per pallet	69,12 m ² 1065,60 kg 64 box	69,12 m ² 1065,60 kg 64 box	69,12 m ² 829,44 kg 72 box	69,12 m ² 829,44 kg 72 box
Mindestabgabeneinheit · Min. sales unit	P (box)	P (box)	P (box)	P (box)
Berechnungseinheit · Calculation unit	m ²	m ²	m ²	m ²
Preisgruppe · Price group	P87	P87	P77	P77
	5 x 5 cm	5 x 5 cm		
	□ 0,09 m ² 298 x 298 mm	□ 0,09 m ² 298 x 298 mm		
Artikelnummer · Article number	2706	2706		
	CT77 3 R10 B	CT66 3 R10 B		
Warengruppe · Product group	Grundfliese · Basic tile	Grundfliese · Basic tile		
Werkmaße · Dimensions (mm)	48 x 48 x 6 mm	48 x 48 x 6 mm		
Farbe · Colour	greige multicolor · greige multicolour	grau multicolor · grey multicolour		
Oberfläche · Finish	matt Dezent schattierte Keramik · matt Subtly shaded ceramic	matt Dezent schattierte Keramik · matt Subtly shaded ceramic		
Erzeugnisgruppe	Feinsteinzeug glasiert	Feinsteinzeug glasiert		
Material	Glazed porcelain stoneware	Glazed porcelain stoneware		
Maßeinheit · Unit of measure	m ² 11,77 kg 11 pce	m ² 11,77 kg 11 pce		
Pro Paket · Per box	1 m ² 11,77 kg 11 pce	1 m ² 11,77 kg 11 pce		
Pro Palette · Per pallet	78 m ² 918,06 kg 78 box	78 m ² 918,06 kg 78 box		
Mindestabgabeneinheit · Min. sales unit	P (box)	P (box)		
Berechnungseinheit · Calculation unit	m ²	m ²		
Preisgruppe · Price group	P117	P117		

X-PLANE Architektur Design (System) · Architecture Design (System)

	60 x 120 cm	60 x 120 cm	60 x 120 cm	60 x 120 cm
Artikelnummer · Article number	2357	2357	2357	2357
Warengruppe · Product group	ZM10	ZM20	ZM70	ZM00
Werkmaße · Dimensions (mm)	Grundfliese · Basic tile	Grundfliese · Basic tile	Grundfliese · Basic tile	Grundfliese · Basic tile
Farbe · Colour	597 x 1197 x 10 mm	597 x 1197 x 10 mm	597 x 1197 x 10 mm	597 x 1197 x 10 mm
Oberfläche · Finish	creme	beige	greige	weiß · white
Erzeugnisgruppe	matt Dezent schattierte Zementoptik · matt Subtly shaded cement look	matt Dezent schattierte Zementoptik · matt Subtly shaded cement look	matt Dezent schattierte Zementoptik · matt Subtly shaded cement look	matt Dezent schattierte Zementoptik · matt Subtly shaded cement look
Material	VilbostonePlus	VilbostonePlus	VilbostonePlus	VilbostonePlus
Maßeinheit · Unit of measure	Feinsteinzeug	Feinsteinzeug	Feinsteinzeug	Feinsteinzeug
Pro Paket · Per box	Porcelain stoneware	Porcelain stoneware	Porcelain stoneware	Porcelain stoneware
Pro Palette · Per pallet	m ² 21,28 kg 1,39 pce	m ² 21,28 kg 1,39 pce	m ² 21,28 kg 1,39 pce	m ² 21,28 kg 1,39 pce
Mindestabgabereinheit · Min. sales unit	1,44 m ² 30,64 kg 2 pce	1,44 m ² 30,64 kg 2 pce	1,44 m ² 30,64 kg 2 pce	1,44 m ² 30,64 kg 2 pce
Berechnungseinheit · Calculation unit	43,2 m ² 919,2 kg 30 box	43,2 m ² 919,2 kg 30 box	43,2 m ² 919,2 kg 30 box	43,2 m ² 919,2 kg 30 box
Preisgruppe · Price group	P (box)	P (box)	P (box)	P (box)
	m ²	m ²	m ²	m ²
	P110	P110	P110	P110
	60 x 120 cm	60 x 120 cm	60 x 120 cm	
Artikelnummer · Article number	2357	2357	2357	
Warengruppe · Product group	ZM60	ZM90	ZM91	
Werkmaße · Dimensions (mm)	Grundfliese · Basic tile	Grundfliese · Basic tile	Grundfliese · Basic tile	
Farbe · Colour	597 x 1197 x 10 mm	597 x 1197 x 10 mm	597 x 1197 x 10 mm	
Oberfläche · Finish	grau · grey	anthrazit · anthracite	schwarz · black	
Erzeugnisgruppe	matt Dezent schattierte Zementoptik · matt Subtly shaded cement look	matt Dezent schattierte Zementoptik · matt Subtly shaded cement look	matt Dezent schattierte Zementoptik · matt Subtly shaded cement look	
Material	VilbostonePlus	VilbostonePlus	VilbostonePlus	
Maßeinheit · Unit of measure	Feinsteinzeug	Feinsteinzeug	Feinsteinzeug	
Pro Paket · Per box	Porcelain stoneware	Porcelain stoneware	Porcelain stoneware	
Pro Palette · Per pallet	m ² 21,28 kg 1,39 pce	m ² 21,28 kg 1,39 pce	m ² 21,28 kg 1,39 pce	
Mindestabgabereinheit · Min. sales unit	1,44 m ² 30,64 kg 2 pce	1,44 m ² 30,64 kg 2 pce	1,44 m ² 30,64 kg 2 pce	
Berechnungseinheit · Calculation unit	43,2 m ² 919,2 kg 30 box	43,2 m ² 919,2 kg 30 box	43,2 m ² 919,2 kg 30 box	
Preisgruppe · Price group	P (box)	P (box)	P (box)	
	m ²	m ²	m ²	
	P110	P110	P110	











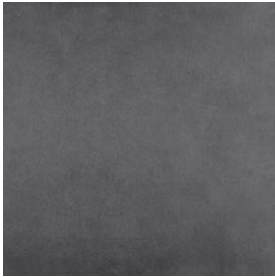
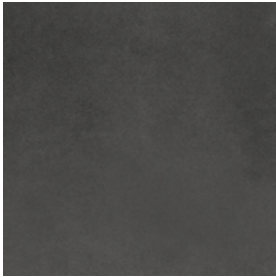





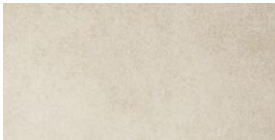
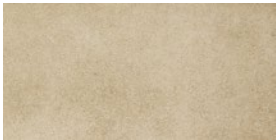

X-PLANE Architektur Design (System) · Architecture Design (System)

	30 x 120 cm	30 x 120 cm	30 x 120 cm	30 x 120 cm
Artikelnummer · Article number	2356	2356	2356	2356
Warengruppe · Product group	ZM10	ZM20	ZM70	ZM00
Werkmaße · Dimensions (mm)	297 x 1197 x 10 mm	297 x 1197 x 10 mm	297 x 1197 x 10 mm	297 x 1197 x 10 mm
Farbe · Colour	creme	beige	greige	weiß · white
Oberfläche · Finish	matt Dezent schattierte Zementoptik · matt Subtly shaded cement look	matt Dezent schattierte Zementoptik · matt Subtly shaded cement look	matt Dezent schattierte Zementoptik · matt Subtly shaded cement look	matt Dezent schattierte Zementoptik · matt Subtly shaded cement look
Erzeugnisgruppe	VilbostonePlus	VilbostonePlus	VilbostonePlus	VilbostonePlus
Material	Feinsteinzeug	Feinsteinzeug	Feinsteinzeug	Feinsteinzeug
Maßeinheit · Unit of measure	Porcelain stoneware	Porcelain stoneware	Porcelain stoneware	Porcelain stoneware
Pro Paket · Per box	m ² 22,22 kg 2,78 pce	m ² 22,22 kg 2,78 pce	m ² 22,22 kg 2,78 pce	m ² 22,22 kg 2,78 pce
Pro Palette · Per pallet	1,44 m ² 32 kg 4 pce	1,44 m ² 32 kg 4 pce	1,44 m ² 32 kg 4 pce	1,44 m ² 32 kg 4 pce
Mindestabgabereinheit · Min. sales unit	43,20 m ² 960 kg 30 box	43,20 m ² 960 kg 30 box	43,20 m ² 960 kg 30 box	43,20 m ² 960 kg 30 box
Berechnungseinheit · Calculation unit	P (box)	P (box)	P (box)	P (box)
Preisgruppe · Price group	m ²	m ²	m ²	m ²
	P145	P145	P145	P145
	30 x 120 cm	30 x 120 cm	30 x 120 cm	
Artikelnummer · Article number	2356	2356	2356	
Warengruppe · Product group	ZM60	ZM90	ZM91	
Werkmaße · Dimensions (mm)	297 x 1197 x 10 mm	297 x 1197 x 10 mm	297 x 1197 x 10 mm	
Farbe · Colour	grau · grey	anthrazit · anthracite	schwarz · black	
Oberfläche · Finish	matt Dezent schattierte Zementoptik · matt Subtly shaded cement look	matt Dezent schattierte Zementoptik · matt Subtly shaded cement look	matt Dezent schattierte Zementoptik · matt Subtly shaded cement look	
Erzeugnisgruppe	VilbostonePlus	VilbostonePlus	VilbostonePlus	
Material	Feinsteinzeug	Feinsteinzeug	Feinsteinzeug	
Maßeinheit · Unit of measure	Porcelain stoneware	Porcelain stoneware	Porcelain stoneware	
Pro Paket · Per box	m ² 22,22 kg 2,78 pce	m ² 22,22 kg 2,78 pce	m ² 22,22 kg 2,78 pce	
Pro Palette · Per pallet	1,44 m ² 32 kg 4 pce	1,44 m ² 32 kg 4 pce	1,44 m ² 32 kg 4 pce	
Mindestabgabereinheit · Min. sales unit	43,20 m ² 960 kg 30 box	43,20 m ² 960 kg 30 box	43,20 m ² 960 kg 30 box	
Berechnungseinheit · Calculation unit	P (box)	P (box)	P (box)	
Preisgruppe · Price group	m ²	m ²	m ²	
	P145	P145	P145	

X-PLANE Architektur Design (System) · Architecture Design (System)

	<p>30 x 120 cm</p>	<p>60 x 60 cm</p>	<p>60 x 60 cm</p>	
<p>Artikelnummer · Article number</p> <p>Warengruppe · Product group</p> <p>Werkmaße · Dimensions (mm)</p> <p>Farbe · Colour</p> <p>Oberfläche · Finish</p> <p>Erzeugnisgruppe</p> <p>Material</p> <p>Maßeinheit · Unit of measure</p> <p>Pro Paket · Per box</p> <p>Pro Palette · Per pallet</p> <p>Mindestabgabereinheit · Min. sales unit</p> <p>Berechnungseinheit · Calculation unit</p> <p>Preisgruppe · Price group</p>	<p>2358</p> <p>ZM00, ZM10, ZM20 ZM70, ZM90, ZM91 ZM60</p> <p>Treppenauftritt · Stair tread</p> <p>297 x 1197 x 10 mm</p> <p>-</p> <p>matt Dezent schattierte Zementoptik · matt Subtly shaded cement look</p> <p>VilbostonePlus</p> <p>Feinsteinzeug</p> <p>Porcelain stoneware</p> <p>m 5,89 kg 0,83 pce</p> <p>2,41 m 14,20 kg 2 pce</p> <p>106,02 m 624,80 kg 44 box</p> <p>E (pce)</p> <p>Stück · piece</p> <p>E119</p>	<p>2349</p> <p>ZM10</p> <p>Grundfliese · Basic tile</p> <p>597 x 597 x 10 mm</p> <p>creme</p> <p>matt Dezent schattierte Zementoptik · matt Subtly shaded cement look</p> <p>VilbostonePlus</p> <p>Feinsteinzeug</p> <p>Porcelain stoneware</p> <p>m² 22,22 kg 2,78 pce</p> <p>1,44 m² 32 kg 4 pce</p> <p>43,20 m² 960 kg 30 box</p> <p>P (box)</p> <p>m²</p> <p>P93</p>	<p>2349</p> <p>ZM20</p> <p>Grundfliese · Basic tile</p> <p>597 x 597 x 10 mm</p> <p>beige</p> <p>matt Dezent schattierte Zementoptik · matt Subtly shaded cement look</p> <p>VilbostonePlus</p> <p>Feinsteinzeug</p> <p>Porcelain stoneware</p> <p>m² 22,22 kg 2,78 pce</p> <p>1,44 m² 32 kg 4 pce</p> <p>43,20 m² 960 kg 30 box</p> <p>P (box)</p> <p>m²</p> <p>P93</p>	
	<p>Auftragsbezogene Fertigung der Treppen in der zu bestellten Grundfliese passenden Nuance. Lieferzeit auf Anfrage. Steps made to order in the nuance that matches the basic tile ordered. Delivery time on request.</p> <p>60 x 60 cm</p>	<p>60 x 60 cm</p>	<p>60 x 60 cm</p>	
	<p>Artikelnummer · Article number</p> <p>Warengruppe · Product group</p> <p>Werkmaße · Dimensions (mm)</p> <p>Farbe · Colour</p> <p>Oberfläche · Finish</p> <p>Erzeugnisgruppe</p> <p>Material</p> <p>Maßeinheit · Unit of measure</p> <p>Pro Paket · Per box</p> <p>Pro Palette · Per pallet</p> <p>Mindestabgabereinheit · Min. sales unit</p> <p>Berechnungseinheit · Calculation unit</p> <p>Preisgruppe · Price group</p>	<p>2349</p> <p>ZM70</p> <p>Grundfliese · Basic tile</p> <p>597 x 597 x 10 mm</p> <p>greige</p> <p>matt Dezent schattierte Zementoptik · matt Subtly shaded cement look</p> <p>VilbostonePlus</p> <p>Feinsteinzeug</p> <p>Porcelain stoneware</p> <p>m² 22,22 kg 2,78 pce</p> <p>1,44 m² 32 kg 4 pce</p> <p>43,20 m² 960 kg 30 box</p> <p>P (box)</p> <p>m²</p> <p>P93</p>	<p>2349</p> <p>ZM00</p> <p>Grundfliese · Basic tile</p> <p>597 x 597 x 10 mm</p> <p>weiß · white</p> <p>matt Dezent schattierte Zementoptik · matt Subtly shaded cement look</p> <p>VilbostonePlus</p> <p>Feinsteinzeug</p> <p>Porcelain stoneware</p> <p>m² 22,22 kg 2,78 pce</p> <p>1,44 m² 32 kg 4 pce</p> <p>43,20 m² 960 kg 30 box</p> <p>P (box)</p> <p>m²</p> <p>P93</p>	<p>2349</p> <p>ZM60</p> <p>Grundfliese · Basic tile</p> <p>597 x 597 x 10 mm</p> <p>grau · grey</p> <p>matt Dezent schattierte Zementoptik · matt Subtly shaded cement look</p> <p>VilbostonePlus</p> <p>Feinsteinzeug</p> <p>Porcelain stoneware</p> <p>m² 22,22 kg 2,78 pce</p> <p>1,44 m² 32 kg 4 pce</p> <p>43,20 m² 960 kg 30 box</p> <p>P (box)</p> <p>m²</p> <p>P93</p>

X-PLANE Architektur Design (System) · Architecture Design (System)

			
	60 x 60 cm 	60 x 60 cm 	
Artikelnummer · Article number	2349	2349	
Warengruppe · Product group	ZM90   	ZM91   	
Werksmaße · Dimensions (mm)	Grundfliese · Basic tile 597 x 597 x 10 mm	Grundfliese · Basic tile 597 x 597 x 10 mm	
Farbe · Colour	anthrazit · anthracite	schwarz · black	
Oberfläche · Finish	matt Dezent schattierte Zementoptik · matt Subtly shaded cement look VilbostonePlus	matt Dezent schattierte Zementoptik · matt Subtly shaded cement look VilbostonePlus	
Erzeugnisgruppe	Feinsteinzeug	Feinsteinzeug	
Material	Porcelain stoneware	Porcelain stoneware	
Maßeinheit · Unit of measure	m ² 22,22 kg 2,78 pce	m ² 22,22 kg 2,78 pce	
Pro Paket · Per box	1,44 m ² 32 kg 4 pce	1,44 m ² 32 kg 4 pce	
Pro Palette · Per pallet	43,20 m ² 960 kg 30 box	43,20 m ² 960 kg 30 box	
Mindestabgabereinheit · Min. sales unit	P (box)	P (box)	
Berechnungseinheit · Calculation unit	m ²	m ²	
Preisgruppe · Price group	P93	P93	
			
	30 x 60 cm 	30 x 60 cm 	30 x 60 cm 
Artikelnummer · Article number	2392	2392	2392
Warengruppe · Product group	ZM10  	ZM20  	ZM70  
Werksmaße · Dimensions (mm)	Grundfliese · Basic tile 297 x 597 x 10 mm	Grundfliese · Basic tile 297 x 597 x 10 mm	Grundfliese · Basic tile 297 x 597 x 10 mm
Farbe · Colour	creme	beige	greige
Oberfläche · Finish	matt Dezent schattierte Zementoptik · matt Subtly shaded cement look VilbostonePlus	matt Dezent schattierte Zementoptik · matt Subtly shaded cement look VilbostonePlus	matt Dezent schattierte Zementoptik · matt Subtly shaded cement look VilbostonePlus
Erzeugnisgruppe	Feinsteinzeug	Feinsteinzeug	Feinsteinzeug
Material	Porcelain stoneware	Porcelain stoneware	Porcelain stoneware
Maßeinheit · Unit of measure	m ² 22,22 kg 5,56 pce	m ² 22,22 kg 5,56 pce	m ² 22,22 kg 5,56 pce
Pro Paket · Per box	1,08 m ² 24 kg 6 pce	1,08 m ² 24 kg 6 pce	1,08 m ² 24 kg 6 pce
Pro Palette · Per pallet	43,20 m ² 960 kg 40 box	43,20 m ² 960 kg 40 box	43,20 m ² 960 kg 40 box
Mindestabgabereinheit · Min. sales unit	P (box)	P (box)	P (box)
Berechnungseinheit · Calculation unit	m ²	m ²	m ²
Preisgruppe · Price group	P87	P87	P87





X-PLANE

Architektur Design (System) · Architecture Design (System)

	30 x 60 cm	30 x 60 cm	30 x 60 cm	30 x 60 cm
Artikelnummer · Article number	2392	2392	2392	2392
Warengruppe · Product group	Grundfliese · Basic tile	Grundfliese · Basic tile	Grundfliese · Basic tile	Grundfliese · Basic tile
Werkgröße · Dimensions (mm)	297 x 597 x 10 mm	297 x 597 x 10 mm	297 x 597 x 10 mm	297 x 597 x 10 mm
Farbe · Colour	weiß · white	grau · grey	anthrazit · anthracite	schwarz · black
Oberfläche · Finish	matt Dezent schattierte Zementoptik · matt Subtly shaded cement look	matt Dezent schattierte Zementoptik · matt Subtly shaded cement look	matt Dezent schattierte Zementoptik · matt Subtly shaded cement look	matt Dezent schattierte Zementoptik · matt Subtly shaded cement look
Erzeugnisgruppe	Feinsteinzeug	Feinsteinzeug	Feinsteinzeug	Feinsteinzeug
Material	Porcelain stoneware	Porcelain stoneware	Porcelain stoneware	Porcelain stoneware
Maßeinheit · Unit of measure	m ² 22,22 kg 5,56 pce	m ² 22,22 kg 5,56 pce	m ² 22,22 kg 5,56 pce	m ² 22,22 kg 5,56 pce
Pro Paket · Per box	1,08 m ² 24 kg 6 pce	1,08 m ² 24 kg 6 pce	1,08 m ² 24 kg 6 pce	1,08 m ² 24 kg 6 pce
Pro Palette · Per pallet	43,20 m ² 960 kg 40 box	43,20 m ² 960 kg 40 box	43,20 m ² 960 kg 40 box	43,20 m ² 960 kg 40 box
Mindestabgabeneinheit · Min. sales unit	P (box)	P (box)	P (box)	P (box)
Berechnungseinheit · Calculation unit	m ²	m ²	m ²	m ²
Preisgruppe · Price group	P87	P87	P87	P87
	30 x 60 cm	30 x 60 cm	15 x 60 cm	7,5 x 60 cm
Artikelnummer · Article number	2353	2680	2352	2351
Warengruppe · Product group	Grundfliese · Basic tile	Grundfliese · Basic tile	Grundfliese · Basic tile	Grundfliese · Basic tile
Werkgröße · Dimensions (mm)	297 x 597 x 10 mm	297 x 597 x 10 mm	147 x 597 x 10 mm	72 x 597 x 10 mm
Farbe · Colour	-	-	-	-
Oberfläche · Finish	matt Dezent schattierte Zementoptik reliefiert · matt Subtly shaded cement look relief	matt Dezent schattierte Zementoptik reliefiert · matt Subtly shaded cement look relief	matt Dezent schattierte Zementoptik · matt Subtly shaded cement look	matt Dezent schattierte Zementoptik · matt Subtly shaded cement look
Erzeugnisgruppe	Feinsteinzeug	Feinsteinzeug	Feinsteinzeug	Feinsteinzeug
Material	Porcelain stoneware	Porcelain stoneware	Porcelain stoneware	Porcelain stoneware
Maßeinheit · Unit of measure	m ² 22,22 kg 5,56 pce	m ² 21,39 kg 5,56 pce	m ² 22,22 kg 11,11 pce	m ² 22,22 kg 22,22 pce
Pro Paket · Per box	1,08 m ² 24 kg 6 pce	1,08 m ² 23,10 kg 6 pce	0,90 m ² 20 kg 10 pce	0,90 m ² 20 kg 20 pce
Pro Palette · Per pallet	43,20 m ² 960 kg 40 box	43,20 m ² 924 kg 40 box	43,20 m ² 960 kg 48 box	43,20 m ² 960 kg 48 box
Mindestabgabeneinheit · Min. sales unit	P (box)	P (box)	P (box)	P (box)
Berechnungseinheit · Calculation unit	m ²	m ²	m ²	m ²
Preisgruppe · Price group	P87	P87	P134	P142

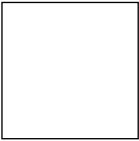

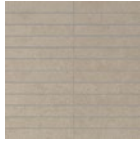
Auftragsbezogene Fertigung. Mindestbestellmenge 100 m². Lieferzeit auf Anfrage.
 Custom-made production. Minimum order quantity 100 m². Delivery time on request.

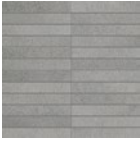
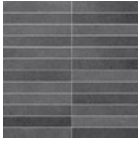
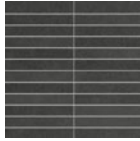
X-PLANE Architektur Design (System) · Architecture Design (System)

				
	30 x 30 cm	2,5 x 15 cm □ 0,09 m ² 298 x 298 mm	2,5 x 15 cm □ 0,09 m ² 298 x 298 mm	2,5 x 15 cm □ 0,09 m ² 298 x 298 mm
Artikelnummer · Article number	2359	2354	2354	2354
Warengruppe · Product group	ZM00, ZM10, ZM20 ZM60, ZM70, ZM90 ZM91	ZM10	ZM20	ZM70
Werkmaße · Dimensions (mm)	Grundfliese · Basic tile 297 x 297 x 10 mm	Grundfliese · Basic tile 23 x 148 x 10 mm	Grundfliese · Basic tile 23 x 148 x 10 mm	Grundfliese · Basic tile 23 x 148 x 10 mm
Farbe · Colour	-	creme	beige	greige
Oberfläche · Finish	matt Dezent schattierte Zementoptik · matt Subtly shaded cement look VilbostonePlus	matt Dezent schattierte Zementoptik · matt Subtly shaded cement look VilbostonePlus	matt Dezent schattierte Zementoptik · matt Subtly shaded cement look VilbostonePlus	matt Dezent schattierte Zementoptik · matt Subtly shaded cement look VilbostonePlus
Erzeugnisgruppe	Feinsteinzeug	Feinsteinzeug	Feinsteinzeug	Feinsteinzeug
Material	Porcelain stoneware	Porcelain stoneware	Porcelain stoneware	Porcelain stoneware
Maßeinheit · Unit of measure	m ² 22 kg 11 pce	m ² 22 kg 11 pce	m ² 22 kg 11 pce	m ² 22 kg 11 pce
Pro Paket · Per box	1 m ² 22 kg 11 pce	1 m ² 22 kg 11 pce	1 m ² 22 kg 11 pce	1 m ² 22 kg 11 pce
Pro Palette · Per pallet	48 m ² 1056 kg 48 box	36 m ² 792 kg 36 box	36 m ² 792 kg 36 box	36 m ² 792 kg 36 box
Mindestabgabeneinheit · Min. sales unit	P (box)	P (box)	P (box)	P (box)
Berechnungseinheit · Calculation unit	m ²	m ²	m ²	m ²
Preisgruppe · Price group	P105	P181	P181	P181
	Auftragsbezogene Fertigung. Lieferzeit auf Anfrage. Custom-made production. Delivery time on request.			
				
	2,5 x 15 cm □ 0,09 m ² 298 x 298 mm	2,5 x 15 cm □ 0,09 m ² 298 x 298 mm	2,5 x 15 cm □ 0,09 m ² 298 x 298 mm	2,5 x 15 cm □ 0,09 m ² 298 x 298 mm
Artikelnummer · Article number	2354	2354	2354	2354
Warengruppe · Product group	ZM00	ZM60	ZM90	ZM91
Werkmaße · Dimensions (mm)	Grundfliese · Basic tile 23 x 148 x 10 mm	Grundfliese · Basic tile 23 x 148 x 10 mm	Grundfliese · Basic tile 23 x 148 x 10 mm	Grundfliese · Basic tile 23 x 148 x 10 mm
Farbe · Colour	weiß · white	grau · grey	anthrazit · anthracite	schwarz · black
Oberfläche · Finish	matt Dezent schattierte Zementoptik · matt Subtly shaded cement look VilbostonePlus	matt Dezent schattierte Zementoptik · matt Subtly shaded cement look VilbostonePlus	matt Dezent schattierte Zementoptik · matt Subtly shaded cement look VilbostonePlus	matt Dezent schattierte Zementoptik · matt Subtly shaded cement look VilbostonePlus
Erzeugnisgruppe	Feinsteinzeug	Feinsteinzeug	Feinsteinzeug	Feinsteinzeug
Material	Porcelain stoneware	Porcelain stoneware	Porcelain stoneware	Porcelain stoneware
Maßeinheit · Unit of measure	m ² 22 kg 11 pce	m ² 22 kg 11 pce	m ² 22 kg 11 pce	m ² 22 kg 11 pce
Pro Paket · Per box	1 m ² 22 kg 11 pce	1 m ² 22 kg 11 pce	1 m ² 22 kg 11 pce	1 m ² 22 kg 11 pce
Pro Palette · Per pallet	36 m ² 792 kg 36 box	36 m ² 792 kg 36 box	36 m ² 792 kg 36 box	36 m ² 792 kg 36 box
Mindestabgabeneinheit · Min. sales unit	P (box)	P (box)	P (box)	P (box)
Berechnungseinheit · Calculation unit	m ²	m ²	m ²	m ²
Preisgruppe · Price group	P181	P181	P181	P181

X-PLANE

Architektur Design (System) · Architecture Design (System)

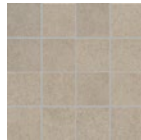
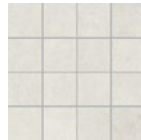
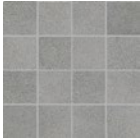
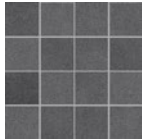
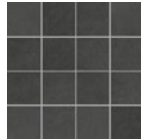
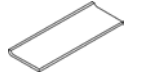
				
	7,5 x 7,5 cm	7,5 x 7,5 cm	7,5 x 7,5 cm	7,5 x 7,5 cm
	□ 0,09 m ² 297 x 297 mm	□ 0,09 m ² 297 x 297 mm	□ 0,09 m ² 297 x 297 mm	□ 0,09 m ² 297 x 297 mm
Artikelnummer · Article number	2362	2362	2362	2362
Warengruppe · Product group	ZM10	ZM20	ZM70	ZM00
Werkmaße · Dimensions (mm)	Grundfliese · Basic tile	Grundfliese · Basic tile	Grundfliese · Basic tile	Grundfliese · Basic tile
Farbe · Colour	72 x 72 x 10 mm	72 x 72 x 10 mm	72 x 72 x 10 mm	72 x 72 x 10 mm
Oberfläche · Finish	creme	beige	greige	weiß · white
Erzeugnisgruppe	matt Dezent schattierte Zementoptik · matt Subtly shaded cement look	matt Dezent schattierte Zementoptik · matt Subtly shaded cement look	matt Dezent schattierte Zementoptik · matt Subtly shaded cement look	matt Dezent schattierte Zementoptik · matt Subtly shaded cement look
Material	VilbostonePlus	VilbostonePlus	VilbostonePlus	VilbostonePlus
Maßeinheit · Unit of measure	Feinsteinzeug	Feinsteinzeug	Feinsteinzeug	Feinsteinzeug
Pro Paket · Per box	Porcelain stoneware	Porcelain stoneware	Porcelain stoneware	Porcelain stoneware
Pro Palette · Per pallet	m ² 23,10 kg 11 pce	m ² 23,10 kg 11 pce	m ² 23,10 kg 11 pce	m ² 23,10 kg 11 pce
Mindestabgabeneinheit · Min. sales unit	1 m ² 23,10 kg 11 pce	1 m ² 23,10 kg 11 pce	1 m ² 23,10 kg 11 pce	1 m ² 23,10 kg 11 pce
Berechnungseinheit · Calculation unit	36 m ² 831,60 kg 36 box	36 m ² 831,60 kg 36 box	36 m ² 831,60 kg 36 box	36 m ² 831,60 kg 36 box
Preisgruppe · Price group	P (box)	P (box)	P (box)	P (box)
	m ²	m ²	m ²	m ²
	P181	P181	P181	P181
				
	7,5 x 7,5 cm	7,5 x 7,5 cm	7,5 x 7,5 cm	
	□ 0,09 m ² 297 x 297 mm	□ 0,09 m ² 297 x 297 mm	□ 0,09 m ² 297 x 297 mm	
Artikelnummer · Article number	2362	2362	2362	2493
Warengruppe · Product group	ZM60	ZM90	ZM91	ZM00, ZM10, ZM20
Werkmaße · Dimensions (mm)	Grundfliese · Basic tile	Grundfliese · Basic tile	Grundfliese · Basic tile	Grundfliese · Basic tile
Farbe · Colour	72 x 72 x 10 mm	72 x 72 x 10 mm	72 x 72 x 10 mm	72 x 72 x 10 mm
Oberfläche · Finish	grau · grey	anthrazit · anthracite	schwarz · black	schwarz · black
Erzeugnisgruppe	matt Dezent schattierte Zementoptik · matt Subtly shaded cement look	matt Dezent schattierte Zementoptik · matt Subtly shaded cement look	matt Dezent schattierte Zementoptik · matt Subtly shaded cement look	matt Dezent schattierte Zementoptik · matt Subtly shaded cement look
Material	VilbostonePlus	VilbostonePlus	VilbostonePlus	VilbostonePlus
Maßeinheit · Unit of measure	Feinsteinzeug	Feinsteinzeug	Feinsteinzeug	Feinsteinzeug
Pro Paket · Per box	Porcelain stoneware	Porcelain stoneware	Porcelain stoneware	Porcelain stoneware
Pro Palette · Per pallet	m ² 23,10 kg 11 pce	m ² 23,10 kg 11 pce	m ² 23,10 kg 11 pce	m ² 23,10 kg 11 pce
Mindestabgabeneinheit · Min. sales unit	1 m ² 23,10 kg 11 pce	1 m ² 23,10 kg 11 pce	1 m ² 23,10 kg 11 pce	1 m ² 23,10 kg 11 pce
Berechnungseinheit · Calculation unit	36 m ² 831,60 kg 36 box	36 m ² 831,60 kg 36 box	36 m ² 831,60 kg 36 box	36 m ² 831,60 kg 36 box
Preisgruppe · Price group	P (box)	P (box)	P (box)	P (box)
	m ²	m ²	m ²	m ²
	P181	P181	P181	E49
				Hohlkehlssockel · Cove base
				107 x 297 x 9 mm
				-
				matt Dezent schattierte Zementoptik · matt Subtly shaded cement look
				VilbostonePlus
				Feinsteinzeug
				Porcelain stoneware
				m 1,67 kg 3,33 pce
				6,01 m 10 kg 20 pce
				420,42 m 700 kg 70 box
				E (pce)
				Stück · piece



Fliesen | Tiles: NOCTURNE OPTIMA, METALYN OPTIMA



reddot design award
winner 2018























































OPTIMA



Fliesen | Tiles: SPOTLIGHT OPTIMA



Fliesen | Tiles: URBAN JUNGLE OPTIMA

						
				120 x 260 cm	120 x 120 cm	60 x 120 cm
						
HUDSON OPTIMA	white sand		 R9	Art. 2962 SD1B	Art. 2961 SD1B	Art. 2960 SD1B
	sand		 R9	Art. 2962 SD2B	Art. 2961 SD2B	Art. 2960 SD2B
	clay		 R9	Art. 2962 SD7B	Art. 2961 SD7B	Art. 2960 SD7B
	volcano		 R9	Art. 2962 SD9B	Art. 2961 SD9B	Art. 2960 SD9B
	Material · Material			Feinsteinzeug Porcelain stoneware	Feinsteinzeug Porcelain stoneware	Feinsteinzeug Porcelain stoneware
	Fabrikationsmaße · Actual size			1197 x 2600 x 6 mm*	1197 x 1197 x 6 mm	597 x 1197 x 6 mm
	Seite · Page			146	148	149
METALYN OPTIMA	silver		 R9	Art. 2962 BM09 	Art. 2961 BM06	Art. 2960 BM06
	bronze		 R9	Art. 2962 BM79 	Art. 2961 BM70	Art. 2960 BM70
	iron		 R9	Art. 2962 BM49 	Art. 2961 BM40	Art. 2960 BM40
	steel		 R9	Art. 2962 BM68 	Art. 2961 BM60	Art. 2960 BM60
	Material · Material			Feinsteinzeug glasiert Glazed porcelain stoneware	Feinsteinzeug Porcelain stoneware	Feinsteinzeug Porcelain stoneware
	Fabrikationsmaße · Actual size			1197 x 2600 x 6 mm*	1197 x 1197 x 6 mm	597 x 1197 x 6 mm
	Seite · Page			50	52	53
NOCTURNE OPTIMA	white		 R9	Art. 2962 ZN1P 	Art. 2961 ZN1P 	Art. 2960 ZN1P
	white gold		 R9	Art. 2962 ZN2P 	Art. 2961 ZN2P 	Art. 2960 ZN2P
	black		 R9	Art. 2962 ZN9P 	Art. 2961 ZN9P 	Art. 2960 ZN9P
	Material · Material			Feinsteinzeug glasiert Glazed porcelain stoneware	Feinsteinzeug glasiert Glazed porcelain stoneware	
	Fabrikationsmaße · Actual size			1198 x 2598 x 6 mm	1198 x 1198 x 6 mm	
	Seite · Page			67	69	
SPOTLIGHT OPTIMA	white		 R9	Art. 2962 CM0M	Art. 2961 CM0M	Art. 2960 CM0M
	greige		 R9	Art. 2962 CM7M	Art. 2961 CM7M	Art. 2960 CM7M
	grey		 R9	Art. 2962 CM6M	Art. 2961 CM6M	Art. 2960 CM6M
	anthracite		 R9	Art. 2962 CM9M	Art. 2961 CM9M	Art. 2960 CM9M
	Material · Material			Feinsteinzeug Porcelain stoneware	Feinsteinzeug Porcelain stoneware	Feinsteinzeug Porcelain stoneware
	Fabrikationsmaße · Actual size			1197 x 2600 x 6 mm*	1197 x 1197 x 6 mm	597 x 1197 x 6 mm
	Seite · Page			100	102	103
URBAN JUNGLE OPTIMA	light grey		 R9	Art. 2962 TC10	Art. 2961 TC10	Art. 2960 TC10
	greige		 R9	Art. 2962 TC70	Art. 2961 TC70	Art. 2960 TC70
	grey		 R9	Art. 2962 TC60	Art. 2961 TC60	Art. 2960 TC60
	dark grey		 R9	Art. 2962 TC90	Art. 2961 TC90	Art. 2960 TC90
	Material · Material			Feinsteinzeug Porcelain stoneware	Feinsteinzeug Porcelain stoneware	Feinsteinzeug Porcelain stoneware
	Fabrikationsmaße · Actual size			1197 x 2600 x 6 mm*	1197 x 1197 x 6 mm	597 x 1197 x 6 mm
	Seite · Page			114	116	117

VERPACKUNGSGINFORMATIONEN · PACKAGING DETAILS

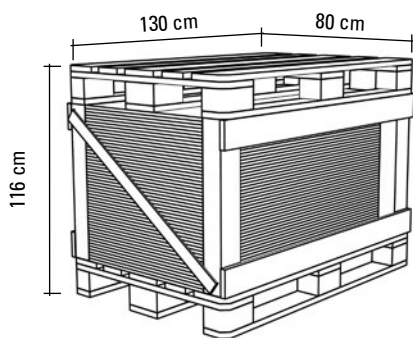

Format 60 x 120 cm							
kg / Stück kg / piece	m ² / Stück m ² / piece	Stück / Paket piece / package	m ² / Paket m ² / package	kg / Paket kg / package	Pakete / Palette package / palett	m ² / Palette m ² / palett	kg / Palette kg / palett
10,00	1,39	2	1,44	20,00	50	72,00	1.000,00

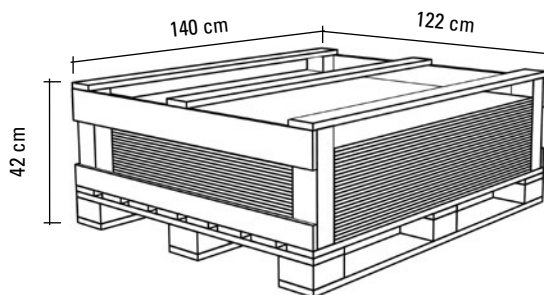

Format 120 x 120 cm							
kg / Stück kg / piece	m ² / Stück m ² / piece	Stück / Paket piece / package	m ² / Paket m ² / package	kg / Paket kg / package	Pakete / Palette package / palett	m ² / Palette m ² / palett	kg / Palette kg / palett
20,06	0,69	2	2,88	40,12	25	72,00	1.003,00

VERPACKUNGSGINFORMATIONEN · PACKAGING DETAILS

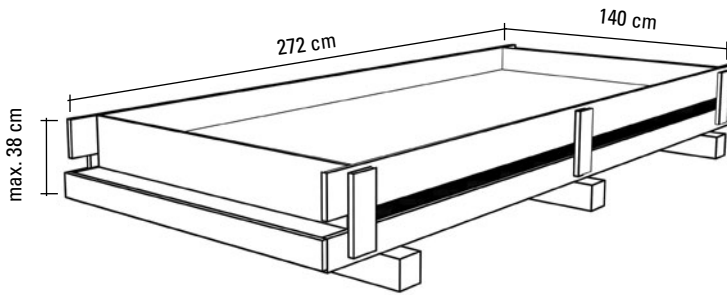

Format 120 x 260 cm					
Serien / Ranges	kg / Stück kg / piece	m ² / Stück m ² / piece	Stück / Kiste piece / box	m ² / Kiste m ² / box	kg / Kiste kg / box
NOCTURNE OPTIMA	43,99	0,32	18	56,16	791,82
HUDSON OPTIMA METALYN OPTIMA SPOTLIGHT OPTIMA URBAN JUNGLE OPTIMA	43,57	0,32	22	68,64	958,54

Verpackung und Transport des Formats 120 x 260 cm der Kollektion OPTIMA erfolgt mittels eines Pfandsystems, dessen Kosten der Kunde trägt. Der Kunde hat die Möglichkeit, die als Pfand berechneten Kisten wieder zurückzusenden und so eine Rückvergütung zu erhalten. Die Rückgabe muss vorab beim Vertriebsinnendienst der V & B Fliesen GmbH angemeldet werden. Die durch die Rücksendung entstehenden Lade- und Frachtkosten trägt der Kunde.

Autorisiertes Personal der V & B Fliesen GmbH wird den Zustand der zurückgegebenen Kisten prüfen und ausschließlich unversehrtes Material entgegennehmen.

The packaging and transport of the OPTIMA collection in the format 120 x 260 cm is covered by a deposit system, the costs of which are borne by the customer. The customer has the option to return the boxes in order for the deposit to be refunded. The return must be announced to the sales team at V & B Fliesen GmbH in advance. The customer shall bear any loading and freight charges incurred as a result of the return.

Authorized personnel at V & B Fliesen GmbH will inspect the condition of the returned boxes and will accept them only if they are intact and undamaged.



Fliesen | Tiles: LUCCA GARDEN



VILBOGARDEN

CÁDIZ GARDEN Vilbogarden

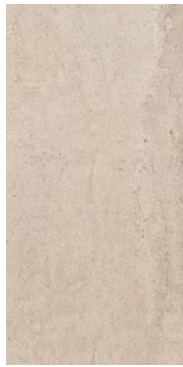

40 x 80 cm



2807

20 mm

BU2M

☼ R11 B ◆

Grundfliese · Basic tile

Werkmaße · Dimensions (mm)
395 x 795 x 20 mm

Farbe · Colour
sand

Oberfläche · Finish
matt | Belebte Kalksteinoptik | reliefiert
· matt | Fresh limestone look | relief

VilbostonePlus

Erzeugnisgruppe
Feinsteinzeug

Material
Porcelain stoneware

Maßeinheit · Unit of measure
m² | 48,94 kg | 3,13 pce

Pro Paket · Per box
0,64 m² | 31,32 kg | 2 pce

Pro Palette · Per pallet
17,28 m² | 845,64 kg | 27 box

Mindestabgabereinheit · Min. sales unit
P (box)

Berechnungseinheit · Calculation unit
m²

Preisgruppe · Price group
P132



40 x 80 cm



2807

20 mm

BU1M

☼ R11 B ◆

Grundfliese · Basic tile

Werkmaße · Dimensions (mm)
395 x 795 x 20 mm

Farbe · Colour
chalk multicolor

Oberfläche · Finish
matt | Belebte Kalksteinoptik | reliefiert
· matt | Fresh limestone look | relief

VilbostonePlus

Erzeugnisgruppe
Feinsteinzeug

Material
Porcelain stoneware

Maßeinheit · Unit of measure
m² | 48,94 kg | 3,13 pce

Pro Paket · Per box
0,64 m² | 31,32 kg | 2 pce

Pro Palette · Per pallet
17,28 m² | 845,64 kg | 27 box

Mindestabgabereinheit · Min. sales unit
P (box)

Berechnungseinheit · Calculation unit
m²

Preisgruppe · Price group
P132



40 x 80 cm



2807

20 mm

BU7M

☼ R11 B ◆

Grundfliese · Basic tile

Werkmaße · Dimensions (mm)
395 x 795 x 20 mm

Farbe · Colour
grey multicolor

Oberfläche · Finish
matt | Belebte Kalksteinoptik | reliefiert
· matt | Fresh limestone look | relief

VilbostonePlus

Erzeugnisgruppe
Feinsteinzeug

Material
Porcelain stoneware

Maßeinheit · Unit of measure
m² | 48,94 kg | 3,13 pce

Pro Paket · Per box
0,64 m² | 31,32 kg | 2 pce

Pro Palette · Per pallet
17,28 m² | 845,64 kg | 27 box

Mindestabgabereinheit · Min. sales unit
P (box)

Berechnungseinheit · Calculation unit
m²

Preisgruppe · Price group
P132



60 x 60 cm



2803

20 mm

BU2M

☼ R11 B ◆

Grundfliese · Basic tile

Werkmaße · Dimensions (mm)
595 x 595 x 20 mm

Farbe · Colour
sand

Oberfläche · Finish
matt | Belebte Kalksteinoptik | reliefiert
· matt | Fresh limestone look | relief

VilbostonePlus

Erzeugnisgruppe
Feinsteinzeug

Material
Porcelain stoneware

Maßeinheit · Unit of measure
m² | 47,58 kg | 2,78 pce

Pro Paket · Per box
0,72 m² | 34,26 kg | 2 pce

Pro Palette · Per pallet
21,60 m² | 1027,80 kg | 30 box

Mindestabgabereinheit · Min. sales unit
P (box)

Berechnungseinheit · Calculation unit
m²

Preisgruppe · Price group
P132



60 x 60 cm



2803

20 mm

BU1M

☼ R11 B ◆

Grundfliese · Basic tile

Werkmaße · Dimensions (mm)
595 x 595 x 20 mm

Farbe · Colour
chalk multicolor

Oberfläche · Finish
matt | Belebte Kalksteinoptik | reliefiert
· matt | Fresh limestone look | relief

VilbostonePlus

Erzeugnisgruppe
Feinsteinzeug

Material
Porcelain stoneware

Maßeinheit · Unit of measure
m² | 47,58 kg | 2,78 pce

Pro Paket · Per box
0,72 m² | 34,26 kg | 2 pce

Pro Palette · Per pallet
21,60 m² | 1027,80 kg | 30 box

Mindestabgabereinheit · Min. sales unit
P (box)

Berechnungseinheit · Calculation unit
m²

Preisgruppe · Price group
P132



60 x 60 cm



2803

20 mm

BU7M

☼ R11 B ◆

Grundfliese · Basic tile

Werkmaße · Dimensions (mm)
595 x 595 x 20 mm

Farbe · Colour
grey multicolor

Oberfläche · Finish
matt | Belebte Kalksteinoptik | reliefiert
· matt | Fresh limestone look | relief

VilbostonePlus

Erzeugnisgruppe
Feinsteinzeug

Material
Porcelain stoneware

Maßeinheit · Unit of measure
m² | 47,58 kg | 2,78 pce

Pro Paket · Per box
0,72 m² | 34,26 kg | 2 pce

Pro Palette · Per pallet
21,60 m² | 1027,80 kg | 30 box

Mindestabgabereinheit · Min. sales unit
P (box)

Berechnungseinheit · Calculation unit
m²

Preisgruppe · Price group
P132

LUCCA GARDEN Vilbogarden





80 x 80 cm



80 x 80 cm



Artikelnummer · Article number	2882	20 mm
Warengruppe · Product group	LS70	
Werksmaße · Dimensions (mm)	Grundfliese · Basic tile	
Farbe · Colour	795 x 795 x 20 mm	
Oberfläche · Finish	sand	
Erzeugnisgruppe	matt Dezente Steinstruktur reliefiert · matt Subtle stone structure relief	
Material	VilbostonePlus	
Maßeinheit · Unit of measure	Feinsteinzeug	
Pro Paket · Per box	Porcelain stoneware	
Pro Palette · Per pallet	m ² 44,38 kg 1,56 pce	
Mindestabgabereinheit · Min. sales unit	0,64 m ² 28,40 kg 1 pce	
Berechnungseinheit · Calculation unit	23,04 m ² 1022,40 kg 36 box	
Preisgruppe · Price group	P (box)	
	m ²	
	P143	

Artikelnummer · Article number	2882	20 mm
Warengruppe · Product group	LS60	
Werksmaße · Dimensions (mm)	Grundfliese · Basic tile	
Farbe · Colour	795 x 795 x 20 mm	
Oberfläche · Finish	stone	
Erzeugnisgruppe	matt Dezente Steinstruktur reliefiert · matt Subtle stone structure relief	
Material	VilbostonePlus	
Maßeinheit · Unit of measure	Feinsteinzeug	
Pro Paket · Per box	Porcelain stoneware	
Pro Palette · Per pallet	m ² 44,38 kg 1,56 pce	
Mindestabgabereinheit · Min. sales unit	0,64 m ² 28,40 kg 1 pce	
Berechnungseinheit · Calculation unit	23,04 m ² 1022,40 kg 36 box	
Preisgruppe · Price group	P (box)	
	m ²	
	P143	





















80 x 80 cm



Artikelnummer · Article number	2882	20 mm
Warengruppe · Product group	LS90	
Werksmaße · Dimensions (mm)	Grundfliese · Basic tile	
Farbe · Colour	795 x 795 x 20 mm	
Oberfläche · Finish	rock	
Erzeugnisgruppe	matt Dezente Steinstruktur reliefiert · matt Subtle stone structure relief	
Material	VilbostonePlus	
Maßeinheit · Unit of measure	Feinsteinzeug	
Pro Paket · Per box	Porcelain stoneware	
Pro Palette · Per pallet	m ² 44,38 kg 1,56 pce	
Mindestabgabereinheit · Min. sales unit	0,64 m ² 28,40 kg 1 pce	
Berechnungseinheit · Calculation unit	23,04 m ² 1022,40 kg 36 box	
Preisgruppe · Price group	P (box)	
	m ²	
	P143	

LUCCA GARDEN Vilbogarden

			
	60 x 60 cm 	60 x 60 cm 	60 x 60 cm 
Artikelnummer · Article number	2867 20 mm	2867 20 mm	2867 20 mm
Warengruppe · Product group	LS70    	LS60    	LS90    
Werkgröße · Dimensions (mm)	Grundfliese · Basic tile 595 x 595 x 20 mm	Grundfliese · Basic tile 595 x 595 x 20 mm	Grundfliese · Basic tile 595 x 595 x 20 mm
Farbe · Colour	sand	stone	rock
Oberfläche · Finish	matt Dezente Steinstruktur reliefiert · matt Subtle stone structure relief VilbostonePlus	matt Dezente Steinstruktur reliefiert · matt Subtle stone structure relief VilbostonePlus	matt Dezente Steinstruktur reliefiert · matt Subtle stone structure relief VilbostonePlus
Erzeugnisgruppe	Feinsteinzeug	Feinsteinzeug	Feinsteinzeug
Material	Porcelain stoneware	Porcelain stoneware	Porcelain stoneware
Maßeinheit · Unit of measure	m ² 47,58 kg 2,78 pce	m ² 47,58 kg 2,78 pce	m ² 47,58 kg 2,78 pce
Pro Paket · Per box	0,72 m ² 34,26 kg 2 pce	0,72 m ² 34,26 kg 2 pce	0,72 m ² 34,26 kg 2 pce
Pro Palette · Per pallet	21,60 m ² 1027,80 kg 30 box	21,60 m ² 1027,80 kg 30 box	21,60 m ² 1027,80 kg 30 box
Mindestabgabereinheit · Min. sales unit	P (box)	P (box)	P (box)
Berechnungseinheit · Calculation unit	m ²	m ²	m ²
Preisgruppe · Price group	P130	P130	P130

MEMPHIS GARDEN Vilbogarden

		
	80 x 80 cm 	80 x 80 cm 
Artikelnummer · Article number	2891 20 mm	2891 20 mm
Warengruppe · Product group	MT06    	MT70    
Werkgröße · Dimensions (mm)	Grundfliese · Basic tile 795 x 795 x 20 mm	Grundfliese · Basic tile 795 x 795 x 20 mm
Farbe · Colour	silver grey	warm grey
Oberfläche · Finish	matt Dezente Betonoptik reliefiert · matt Subtle concrete look relief VilbostonePlus	matt Dezente Betonoptik reliefiert · matt Subtle concrete look relief VilbostonePlus
Erzeugnisgruppe	Feinsteinzeug	Feinsteinzeug
Material	Porcelain stoneware	Porcelain stoneware
Maßeinheit · Unit of measure	m ² 47,92 kg 1,56 pce	m ² 47,92 kg 1,56 pce
Pro Paket · Per box	0,64 m ² 30,67 kg 1 pce	0,64 m ² 30,67 kg 1 pce
Pro Palette · Per pallet	23,04 m ² 1104,12 kg 36 box	23,04 m ² 1104,12 kg 36 box
Mindestabgabereinheit · Min. sales unit	P (box)	P (box)
Berechnungseinheit · Calculation unit	m ²	m ²
Preisgruppe · Price group	P143	P143

MEMPHIS GARDEN Vilbogarden



80 x 80 cm

Artikelnummer - Article number	2891	20 mm
Warengruppe - Product group	Grundfliese - Basic tile	
Werkmaße - Dimensions (mm)	795 x 795 x 20 mm	
Farbe - Colour	dark grey	
Oberfläche - Finish	matt Dezente Betonoptik reliefiert - matt Subtle concrete look relief	
Erzeugnisgruppe	VilbostonePlus	
Material	Feinsteinzeug	
Maßeinheit - Unit of measure	Porcelain stoneware	
Pro Paket - Per box	m ² 47,92 kg 1,56 pce	
Pro Palette - Per pallet	0,64 m ² 30,67 kg 1 pce	
Mindestabgabereinheit - Min. sales unit	23,04 m ² 1104,12 kg 36 box	
Berechnungseinheit - Calculation unit	P (box)	
Preisgruppe - Price group	m ²	
	P143	



60 x 60 cm



60 x 60 cm



60 x 60 cm



Artikelnummer - Article number	2863	20 mm	2863	20 mm	2863	20 mm
Warengruppe - Product group	Grundfliese - Basic tile		Grundfliese - Basic tile		Grundfliese - Basic tile	
Werkmaße - Dimensions (mm)	595 x 595 x 20 mm		595 x 595 x 20 mm		595 x 595 x 20 mm	
Farbe - Colour	silver grey		warm grey		dark grey	
Oberfläche - Finish	matt Dezente Betonoptik reliefiert - matt Subtle concrete look relief		matt Dezente Betonoptik reliefiert - matt Subtle concrete look relief		matt Dezente Betonoptik reliefiert - matt Subtle concrete look relief	
Erzeugnisgruppe	VilbostonePlus		VilbostonePlus		VilbostonePlus	
Material	Feinsteinzeug		Feinsteinzeug		Feinsteinzeug	
Maßeinheit - Unit of measure	Porcelain stoneware		Porcelain stoneware		Porcelain stoneware	
Pro Paket - Per box	m ² 48 kg 2,78 pce		m ² 48 kg 2,78 pce		m ² 48 kg 2,78 pce	
Pro Palette - Per pallet	0,72 m ² 34,56 kg 2 pce		0,72 m ² 34,56 kg 2 pce		0,72 m ² 34,56 kg 2 pce	
Mindestabgabereinheit - Min. sales unit	21,60 m ² 1036,80 kg 30 box		21,60 m ² 1036,80 kg 30 box		21,60 m ² 1036,80 kg 30 box	
Berechnungseinheit - Calculation unit	P (box)		P (box)		P (box)	
Preisgruppe - Price group	m ²		m ²		m ²	
	P130		P130		P130	

MONT BLANC GARDEN Vilbogarden

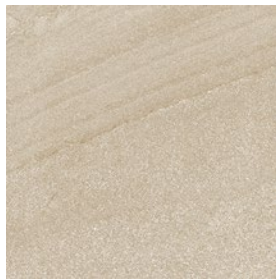

60 x 60 cm

2869 20 mm

GS20

Grundfliese · Basic tile

Werkmaße · Dimensions (mm) 595 x 595 x 20 mm

Farbe · Colour sahara

Oberfläche · Finish matt | Quarzitoptik | reliefiert · matt |

Quartzite look | relief **VilbostonePlus**

Erzeugnisgruppe Feinsteinzeug

Material Porcelain stoneware

Maßeinheit · Unit of measure m² | 48 kg | 2,78 pce

Pro Paket · Per box 0,72 m² | 34,56 kg | 2 pce

Pro Palette · Per pallet 21,60 m² | 1036,80 kg | 30 box

Mindestabgabereinheit · Min. sales unit P (box)

Berechnungseinheit · Calculation unit m²

Preisgruppe · Price group **P130**

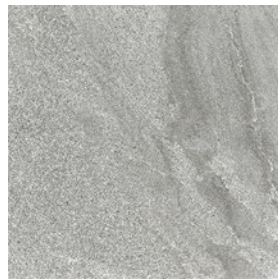

60 x 60 cm

2869 20 mm

GS06

Grundfliese · Basic tile

Werkmaße · Dimensions (mm) 595 x 595 x 20 mm

Farbe · Colour silver

Oberfläche · Finish matt | Quarzitoptik | reliefiert · matt |

Quartzite look | relief **VilbostonePlus**

Erzeugnisgruppe Feinsteinzeug

Material Porcelain stoneware

Maßeinheit · Unit of measure m² | 48 kg | 2,78 pce

Pro Paket · Per box 0,72 m² | 34,56 kg | 2 pce

Pro Palette · Per pallet 21,60 m² | 1036,80 kg | 30 box

Mindestabgabereinheit · Min. sales unit P (box)

Berechnungseinheit · Calculation unit m²

Preisgruppe · Price group **P130**

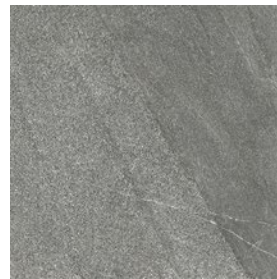

60 x 60 cm

2869 20 mm

GS60

Grundfliese · Basic tile

Werkmaße · Dimensions (mm) 595 x 595 x 20 mm

Farbe · Colour titan

Oberfläche · Finish matt | Quarzitoptik | reliefiert · matt |

Quartzite look | relief **VilbostonePlus**

Erzeugnisgruppe Feinsteinzeug

Material Porcelain stoneware

Maßeinheit · Unit of measure m² | 48 kg | 2,78 pce

Pro Paket · Per box 0,72 m² | 34,56 kg | 2 pce

Pro Palette · Per pallet 21,60 m² | 1036,80 kg | 30 box

Mindestabgabereinheit · Min. sales unit P (box)

Berechnungseinheit · Calculation unit m²

Preisgruppe · Price group **P130**

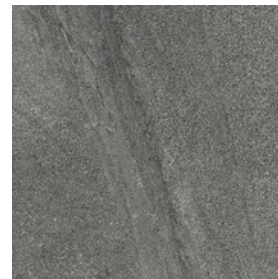

60 x 60 cm

2869 20 mm

GS90

Grundfliese · Basic tile

Werkmaße · Dimensions (mm) 595 x 595 x 20 mm

Farbe · Colour carbon

Oberfläche · Finish matt | Quarzitoptik | reliefiert · matt |

Quartzite look | relief **VilbostonePlus**

Erzeugnisgruppe Feinsteinzeug

Material Porcelain stoneware

Maßeinheit · Unit of measure m² | 48 kg | 2,78 pce

Pro Paket · Per box 0,72 m² | 34,56 kg | 2 pce

Pro Palette · Per pallet 21,60 m² | 1036,80 kg | 30 box

Mindestabgabereinheit · Min. sales unit P (box)

Berechnungseinheit · Calculation unit m²

Preisgruppe · Price group **P130**



80 x 80 cm

2889 20 mm

GS20

Grundfliese · Basic tile

Werkmaße · Dimensions (mm) 795 x 795 x 20 mm

Farbe · Colour sahara

Oberfläche · Finish matt | Quarzitoptik | reliefiert · matt | Quartzite look | relief

VilbostonePlus

Erzeugnisgruppe Feinsteinzeug

Material Porcelain stoneware

Maßeinheit · Unit of measure m² | 47,92 kg | 1,56 pce

Pro Paket · Per box 0,64 m² | 30,67 kg | 1 pce

Pro Palette · Per pallet 23,04 m² | 1104,12 kg | 36 box

Mindestabgabereinheit · Min. sales unit P (box)

Berechnungseinheit · Calculation unit m²

Preisgruppe · Price group **P143**



80 x 80 cm

2889 20 mm

GS06

Grundfliese · Basic tile

Werkmaße · Dimensions (mm) 795 x 795 x 20 mm

Farbe · Colour silver

Oberfläche · Finish matt | Quarzitoptik | reliefiert · matt | Quartzite look | relief

VilbostonePlus

Erzeugnisgruppe Feinsteinzeug

Material Porcelain stoneware

Maßeinheit · Unit of measure m² | 47,92 kg | 1,56 pce

Pro Paket · Per box 0,64 m² | 30,67 kg | 1 pce

Pro Palette · Per pallet 23,04 m² | 1104,12 kg | 36 box

Mindestabgabereinheit · Min. sales unit P (box)

Berechnungseinheit · Calculation unit m²

Preisgruppe · Price group **P143**

MONT BLANC GARDEN Vilbogarden

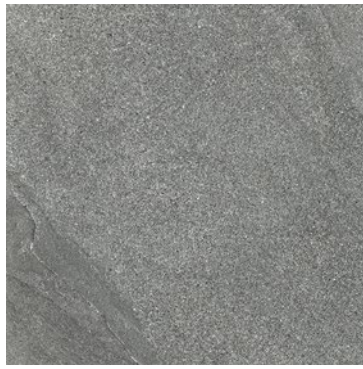

80 x 80 cm

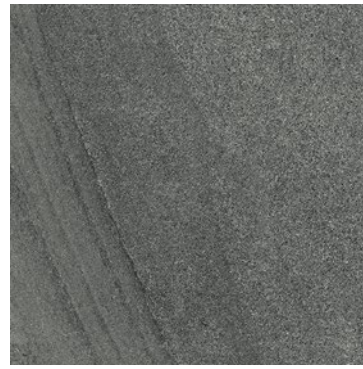

80 x 80 cm

Artikelnummer · Article number	2889	20 mm	2889	20 mm
Warengruppe · Product group	GS60		GS90	
Werkmaße · Dimensions (mm)	Grundfliese · Basic tile		Grundfliese · Basic tile	
Farbe · Colour	795 x 795 x 20 mm		795 x 795 x 20 mm	
Oberfläche · Finish	titan		carbon	
Erzeugnisgruppe	matt Quarzoptik reliefiert · matt Quartzite look relief		matt Quarzoptik reliefiert · matt Quartzite look relief	
Material	VilbostonePlus		VilbostonePlus	
Maßeinheit · Unit of measure	Feinsteinzeug		Feinsteinzeug	
Pro Paket · Per box	Porcelain stoneware		Porcelain stoneware	
Pro Palette · Per pallet	m ² 47,92 kg 1,56 pce		m ² 47,92 kg 1,56 pce	
Mindestabgabereinheit · Min. sales unit	0,64 m ² 30,67 kg 1 pce		0,64 m ² 30,67 kg 1 pce	
Berechnungseinheit · Calculation unit	23,04 m ² 1104,12 kg 36 box		23,04 m ² 1104,12 kg 36 box	
Preisgruppe · Price group	P (box)		P (box)	
	m ²		m ²	
	P143		P143	

MY EARTH GARDEN Vilbogarden



80 x 80 cm



80 x 80 cm

Artikelnummer · Article number	2816	20 mm
Warengruppe · Product group	RU10	
Werksmaße · Dimensions (mm)	Grundfliese · Basic tile	
Farbe · Colour	795 x 795 x 20 mm	
Oberfläche · Finish	light beige	
Erzeugnisgruppe	matt reliefiert · matt relief	VilbostonePlus
Material	Feinsteinzeug	
Maßeinheit · Unit of measure	Porcelain stoneware	
Pro Paket · Per box	m ² 47,92 kg 1,56 pce	
Pro Palette · Per pallet	0,64 m ² 30,67 kg 1 pce	
Mindestabgabereinheit · Min. sales unit	23,04 m ² 1104,12 kg 36 box	
Berechnungseinheit · Calculation unit	P (box)	
Preisgruppe · Price group	m ²	P143



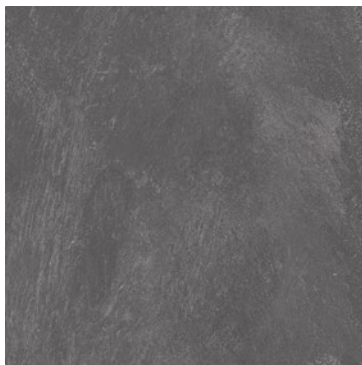









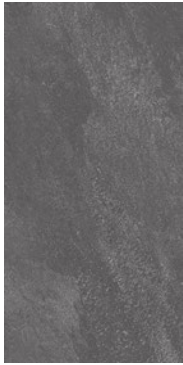









Artikelnummer · Article number	2816	20 mm
Warengruppe · Product group	RU60	
Werksmaße · Dimensions (mm)	Grundfliese · Basic tile	
Farbe · Colour	795 x 795 x 20 mm	
Oberfläche · Finish	grey multicolor	
Erzeugnisgruppe	matt reliefiert · matt relief	VilbostonePlus
Material	Feinsteinzeug	
Maßeinheit · Unit of measure	Porcelain stoneware	
Pro Paket · Per box	m ² 47,92 kg 1,56 pce	
Pro Palette · Per pallet	0,64 m ² 30,67 kg 1 pce	
Mindestabgabereinheit · Min. sales unit	23,04 m ² 1104,12 kg 36 box	
Berechnungseinheit · Calculation unit	P (box)	
Preisgruppe · Price group	m ²	P143



80 x 80 cm

Artikelnummer · Article number	2816	20 mm
Warengruppe · Product group	RU90	
Werksmaße · Dimensions (mm)	Grundfliese · Basic tile	
Farbe · Colour	795 x 795 x 20 mm	
Oberfläche · Finish	anthracite multicolor	
Erzeugnisgruppe	matt reliefiert · matt relief	VilbostonePlus
Material	Feinsteinzeug	
Maßeinheit · Unit of measure	Porcelain stoneware	
Pro Paket · Per box	m ² 47,92 kg 1,56 pce	
Pro Palette · Per pallet	0,64 m ² 30,67 kg 1 pce	
Mindestabgabereinheit · Min. sales unit	23,04 m ² 1104,12 kg 36 box	
Berechnungseinheit · Calculation unit	P (box)	
Preisgruppe · Price group	m ²	P143

MY EARTH GARDEN Vilbogarden

				
	40 x 80 cm 	40 x 80 cm 	40 x 80 cm 	40 x 80 cm 
Artikelnummer · Article number	2806 20 mm	2806 20 mm	2806 20 mm	2806 20 mm
Warengruppe · Product group	RU10 	RU20 	RU60 	RU90 
Werkmaße · Dimensions (mm)	Grundfliese · Basic tile 395 x 795 x 20 mm	Grundfliese · Basic tile 395 x 795 x 20 mm	Grundfliese · Basic tile 395 x 795 x 20 mm	Grundfliese · Basic tile 395 x 795 x 20 mm
Farbe · Colour	light beige	beige multicolor	grey multicolor	anthracite multicolor
Oberfläche · Finish	matt Belebte Quarzitoptik reliefiert · matt Fresh quartzite look relief	matt Belebte Quarzitoptik reliefiert · matt Fresh quartzite look relief	matt Belebte Quarzitoptik reliefiert · matt Fresh quartzite look relief	matt Belebte Quarzitoptik reliefiert · matt Fresh quartzite look relief
Erzeugnisgruppe	VilbostonePlus Feinsteinzeug	VilbostonePlus Feinsteinzeug	VilbostonePlus Feinsteinzeug	VilbostonePlus Feinsteinzeug
Material	Porcelain stoneware	Porcelain stoneware	Porcelain stoneware	Porcelain stoneware
Maßeinheit · Unit of measure	m ² 48,94 kg 3,13 pce	m ² 48,94 kg 3,13 pce	m ² 48,94 kg 3,13 pce	m ² 48,94 kg 3,13 pce
Pro Paket · Per box	0,64 m ² 31,32 kg 2 pce	0,64 m ² 31,32 kg 2 pce	0,64 m ² 31,32 kg 2 pce	0,64 m ² 31,32 kg 2 pce
Pro Palette · Per pallet	17,28 m ² 845,64 kg 27 box	17,28 m ² 845,64 kg 27 box	17,28 m ² 845,64 kg 27 box	17,28 m ² 845,64 kg 27 box
Mindestabgabeneinheit · Min. sales unit	P (box)	P (box)	P (box)	P (box)
Berechnungseinheit · Calculation unit	m ²	m ²	m ²	m ²
Preisgruppe · Price group	P130	P130	P130	P130
				
	60 x 60 cm 	60 x 60 cm 	60 x 60 cm 	60 x 60 cm 
Artikelnummer · Article number	2802 20 mm	2802 20 mm	2802 20 mm	2802 20 mm
Warengruppe · Product group	RU10 	RU20 	RU60 	RU90 
Werkmaße · Dimensions (mm)	Grundfliese · Basic tile 595 x 595 x 20 mm	Grundfliese · Basic tile 595 x 595 x 20 mm	Grundfliese · Basic tile 595 x 595 x 20 mm	Grundfliese · Basic tile 595 x 595 x 20 mm
Farbe · Colour	light beige	beige multicolor	grey multicolor	anthracite multicolor
Oberfläche · Finish	matt Belebte Quarzitoptik reliefiert · matt Fresh quartzite look relief	matt Belebte Quarzitoptik reliefiert · matt Fresh quartzite look relief	matt Belebte Quarzitoptik reliefiert · matt Fresh quartzite look relief	matt Belebte Quarzitoptik reliefiert · matt Fresh quartzite look relief
Erzeugnisgruppe	VilbostonePlus Feinsteinzeug	VilbostonePlus Feinsteinzeug	VilbostonePlus Feinsteinzeug	VilbostonePlus Feinsteinzeug
Material	Porcelain stoneware	Porcelain stoneware	Porcelain stoneware	Porcelain stoneware
Maßeinheit · Unit of measure	m ² 47,58 kg 2,78 pce	m ² 47,58 kg 2,78 pce	m ² 47,58 kg 2,78 pce	m ² 47,58 kg 2,78 pce
Pro Paket · Per box	0,72 m ² 34,26 kg 2 pce	0,72 m ² 34,26 kg 2 pce	0,72 m ² 34,26 kg 2 pce	0,72 m ² 34,26 kg 2 pce
Pro Palette · Per pallet	21,60 m ² 1027,80 kg 30 box	21,60 m ² 1027,80 kg 30 box	21,60 m ² 1027,80 kg 30 box	21,60 m ² 1027,80 kg 30 box
Mindestabgabeneinheit · Min. sales unit	P (box)	P (box)	P (box)	P (box)
Berechnungseinheit · Calculation unit	m ²	m ²	m ²	m ²
Preisgruppe · Price group	P130	P130	P130	P130

OAK LINE GARDEN Vilbogarden



40 x 120 cm



40 x 120 cm



40 x 120 cm

Artikelnummer · Article number	2896	20 mm	2896	20 mm	2896	20 mm
Warengruppe · Product group	WZ10 Grundfliese · Basic tile		WZ20 Grundfliese · Basic tile		WZ80 Grundfliese · Basic tile	
Werksmaße · Dimensions (mm)	395 x 1195 x 20 mm		395 x 1195 x 20 mm		395 x 1195 x 20 mm	
Farbe · Colour	milk		caramel		nut	
Oberfläche · Finish	matt Eichenholzstruktur reliefiert · matt Oak wood structure relief		matt Eichenholzstruktur reliefiert · matt Oak wood structure relief		matt Eichenholzstruktur reliefiert · matt Oak wood structure relief	
Erzeugnisgruppe	Feinsteinzeug		Feinsteinzeug		Feinsteinzeug	
Material	Porcelain stoneware		Porcelain stoneware		Porcelain stoneware	
Maßeinheit · Unit of measure	m ² 48,60 kg 2,08 pce		m ² 48,60 kg 2,08 pce		m ² 48,60 kg 2,08 pce	
Pro Paket · Per box	0,48 m ² 23,33 kg 1 pce		0,48 m ² 23,33 kg 1 pce		0,48 m ² 23,33 kg 1 pce	
Pro Palette · Per pallet	23,04 m ² 1119,84 kg 48 box		23,04 m ² 1119,84 kg 48 box		23,04 m ² 1119,84 kg 48 box	
Mindestabgabeneinheit · Min. sales unit	P (box)		P (box)		P (box)	
Berechnungseinheit · Calculation unit	m ²		m ²		m ²	
Preisgruppe · Price group	P146		P146		P146	

OAK PARK GARDEN Vilbogarden



40 x 120 cm

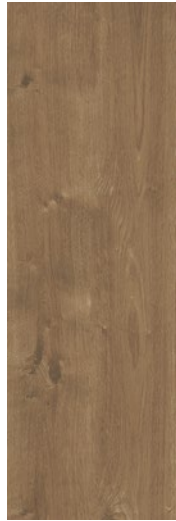

40 x 120 cm

Artikelnummer · Article number	2821	20 mm	2821	20 mm
Warengruppe · Product group	HR20		HR30	
Werkmaße · Dimensions (mm)	Grundfliese · Basic tile		Grundfliese · Basic tile	
Farbe · Colour	395 x 1195 x 20 mm		395 x 1195 x 20 mm	
Oberfläche · Finish	chalette		brandy	
Erzeugnisgruppe	matt Ruhige Eichenholzstruktur reliefiert · matt Calming oak wood structure relief	VilbostonePlus	matt Ruhige Eichenholzstruktur reliefiert · matt Calming oak wood structure relief	VilbostonePlus
Material	Feinsteinzeug		Feinsteinzeug	
Maßeinheit · Unit of measure	Porcelain stoneware		Porcelain stoneware	
Pro Paket · Per box	m ² 49,50 kg 2,08 pce		m ² 49,50 kg 2,08 pce	
Pro Palette · Per pallet	0,96 m ² 47,52 kg 2 pce		0,96 m ² 47,52 kg 2 pce	
Mindestabgabereinheit · Min. sales unit	23,04 m ² 1140,48 kg 24 box		23,04 m ² 1140,48 kg 24 box	
Berechnungseinheit · Calculation unit	P (box)		P (box)	
Preisgruppe · Price group	m ²		m ²	
	P146		P146	

URBAN JUNGLE GARDEN Vilbogarden



80 x 80 cm



80 x 80 cm

Artikelnummer · Article number
Warengruppe · Product group
Werksmaße · Dimensions (mm)
Farbe · Colour
Oberfläche · Finish
Erzeugnisgruppe
Material
Maßeinheit · Unit of measure
Pro Paket · Per box
Pro Palette · Per pallet
Mindestabgabereinheit · Min. sales unit
Berechnungseinheit · Calculation unit
Preisgruppe · Price group

2888	20 mm
TC70	
Grundfliese · Basic tile	
795 x 795 x 20 mm	
greige	
matt Feinkörnige Betonoptik · matt Fine-grained concrete look	
VilbostonePlus	
Feinsteinzeug	
Porcelain stoneware	
m ² 47,92 kg 1,56 pce	
0,64 m ² 30,67 kg 1 pce	
23,04 m ² 1104,12 kg 36 box	
P (box)	
m ²	
P143	

2888	20 mm
TC60	
Grundfliese · Basic tile	
795 x 795 x 20 mm	
grey	
matt Feinkörnige Betonoptik · matt Fine-grained concrete look	
VilbostonePlus	
Feinsteinzeug	
Porcelain stoneware	
m ² 47,92 kg 1,56 pce	
0,64 m ² 30,67 kg 1 pce	
23,04 m ² 1104,12 kg 36 box	
P (box)	
m ²	
P143	



80 x 80 cm

Artikelnummer · Article number
Warengruppe · Product group
Werksmaße · Dimensions (mm)
Farbe · Colour
Oberfläche · Finish
Erzeugnisgruppe
Material
Maßeinheit · Unit of measure
Pro Paket · Per box
Pro Palette · Per pallet
Mindestabgabereinheit · Min. sales unit
Berechnungseinheit · Calculation unit
Preisgruppe · Price group

2888	20 mm
TC90	
Grundfliese · Basic tile	
795 x 795 x 20 mm	
dark grey	
matt Feinkörnige Betonoptik · matt Fine-grained concrete look	
VilbostonePlus	
Feinsteinzeug	
Porcelain stoneware	
m ² 47,92 kg 1,56 pce	
0,64 m ² 30,67 kg 1 pce	
23,04 m ² 1104,12 kg 36 box	
P (box)	
m ²	
P143	

FORMTEILE · FUNCTIONAL TRIMS Select



Randplatte gerundet mit Tropfkante · Border tile, rounded, with drip edge



Schenkelplatte · Nosing tile

FORMTEILE · FUNCTIONAL TRIMS Select

Randplatte mit Tropfkante
Border tile with drip edge

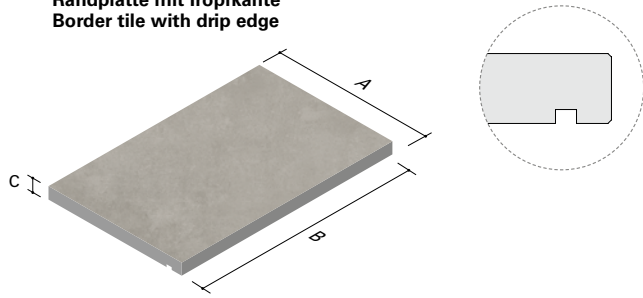

	A (mm)	B (mm)	C (mm)	Art.-Nr.
	295	595	20	28S3
	395	795	20	28S4
	395	1195	20	28S1

Randplatte mit Tropfkante
Border tile with drip edge

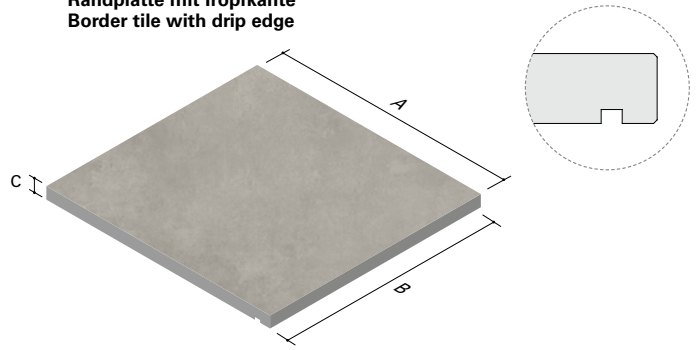

	A (mm)	B (mm)	C (mm)	Art.-Nr.
	595	595	20	28S6
	795	795	20	28S8

Randplatte gerundet mit Tropfkante
Border tile, rounded, with drip edge

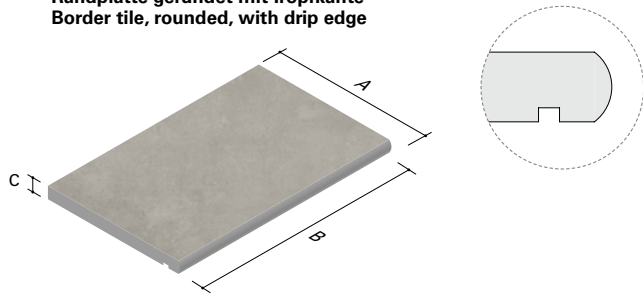

	A (mm)	B (mm)	C (mm)	Art.-Nr.
	295	595	20	28R3
	395	795	20	28R4
	395	1195	20	28R1

Randplatte gerundet mit Tropfkante
Border tile, rounded, with drip edge

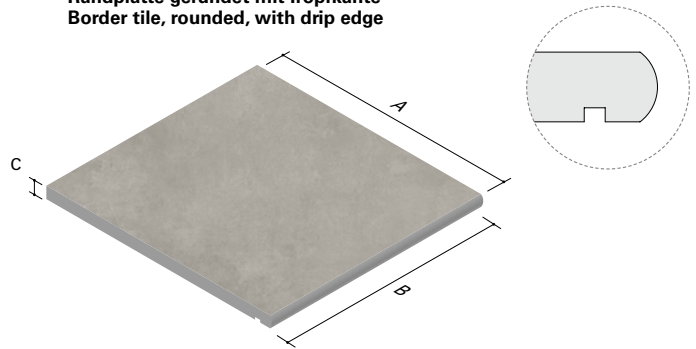

	A (mm)	B (mm)	C (mm)	Art.-Nr.
	595	595	20	28R6
	795	795	20	28R8

Schenkelplatte
Nosing tile

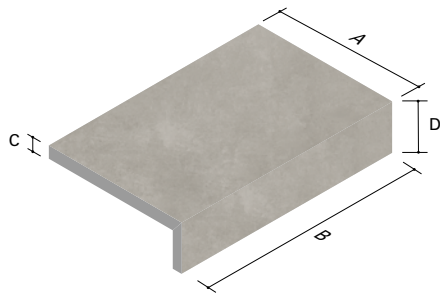

	A (mm)	B (mm)	C (mm)	D (mm)	Art.-Nr.
	350	595	20	145	28W3
	350	795	20	145	28W4
	350	1195	20	145	28W5

Schenkelplatten-Ecke (rechts oder links)
Nosing tile corner (right or left)

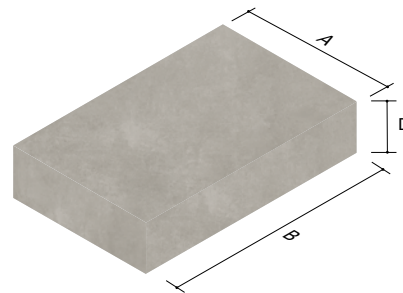

	A (mm)	B (mm)	D (mm)	Art.-Nr.
	350	595	145	28K3
	350	795	145	28K4
	350	1195	145	28K5

FORMTEILE · FUNCTIONAL TRIMS Select

Randplatte mit Tropfkante – Innenecke (2-teilig)
Border tile with drip edge - inside corner (2 pieces)

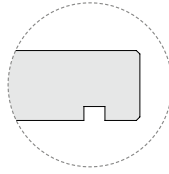
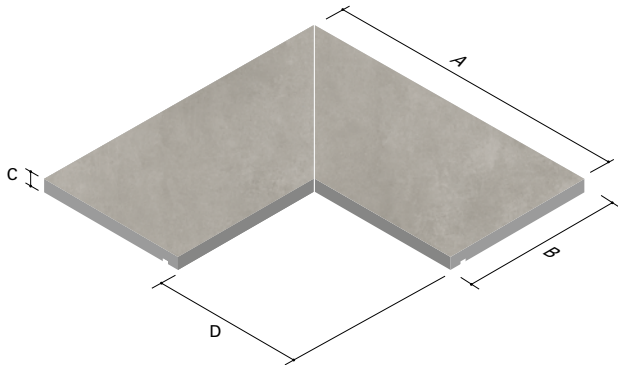

	A (mm)	B (mm)	C (mm)	D (mm)	Art.-Nr.
	591	295	20	296	28F3
	791	395	20	396	28F4
	1191	395	20	796	28F1

Randplatte – Innenecke (2-teilig)
Border tile - inside corner (2 pieces)

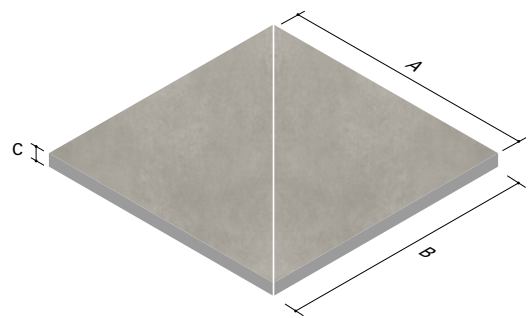

	A (mm)	B (mm)	C (mm)	Art.-Nr.
	591	591	20	28E6
	791	791	20	28E8

Randplatte gerundet mit Tropfkante – Innenecke (2-teilig)
Border tile, rounded, with drip edge - inside corner (2 pieces)

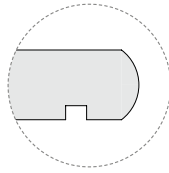
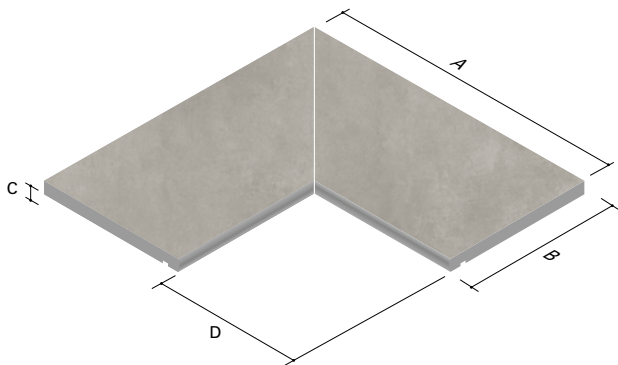

	A (mm)	B (mm)	C (mm)	D (mm)	Art.-Nr.
	591	295	20	296	28E3
	791	395	20	396	28E4
	1191	395	20	796	28E1

Auftragsbezogene Fertigung. Preise und Lieferzeit auf Anfrage.
 Die angegebenen Maße sind die Maximalmaße.
 Geringere Längen/Höhen/Breiten sind auf Anfrage möglich.

Special order only. Prices and delivery time on request.
 The stated dimensions are the maximum dimensions. Smaller lengths/heights/widths are possible on request.

Schenkelplatte-Innenecke
Nosing tile - inside corner

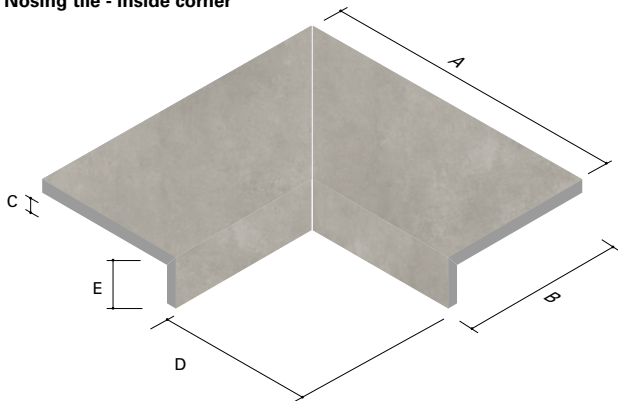

	A (mm)	B (mm)	C (mm)	D (mm)	E (mm)	Art.-Nr.
	591	295	20	296	145	28V3
	791	395	20	396	145	28V4
	1191	395	20	796	145	28V1

Schenkelplatte-Außenecke
Nosing tile - outside corner

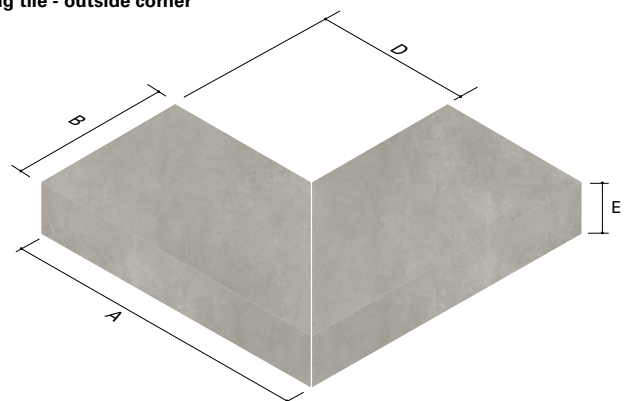

	A (mm)	B (mm)	D (mm)	E (mm)	Art.-Nr.
	591	295	296	145	28Y3
	791	395	396	145	28Y4
	1191	395	796	145	28Y1



Fliesen | Tiles: PURE LINE 2.0, PRO ARCHITECTURA 3.0

Please refer to our website for detailed information on laying and cleaning ceramic tiles.



Simply scan this code with your smartphone



Fliesen | Tiles: CODE 2, URBAN ART

Ausführliche Informationen zu den Themen Verlegung und Reinigung von keramischen Fliesen finden Sie auf unserer Internetseite.



Scannen Sie einfach diesen Code mit Ihrem Smartphone

Technical information | *Technische Informationen*

SLIP RESISTANCE

DIN EN 16165:2021-12

Determination of slip resistance of pedestrian surfaces – Methods of evaluation

As part of the revisions of country-specific standards, in December 2021 a European standard was developed with DIN EN 16165, which lays down uniform measurement methods for the slip resistance of floor coverings; these methods are binding for all European countries.

Slip resistance of floor tiles

The EU Construction Products Regulation No. 305/2011 requires floor coverings to be safe to use. This imposes the observance of special requirements pertaining to slip resistance in areas where a danger of accidents is to be assumed. The corresponding standards were drawn up by the Committee for workplaces (ASTA) and published in form of technical regulations.

These requirements also include those for slip resistance – specification sheet ASR A1.5. Technical regulations for workplaces - Flooring, current version of March 2022 (formerly BGR/GUV-R 181, or DGUV Rule 108-003 for commercial areas) and for barefoot areas the specification sheet ‘DGUV Information 207-006 – Floor coverings for wet barefoot areas’ (previously BGI/GUV-I 8527, updated version of May 2020) of the DGUV accident-insurance association. These two sets of rules serve as a basis and are also used for other areas of use.

Areas subject to a danger of slipping (e.g. circulation areas in public buildings, retail and wholesale premises, swimming

Test procedure

- Testing by walking barefoot on an inclined surface
- Testing by walking on an inclined surface wearing shoes
- Pendulum testing
- Tribometer testing

pools, sanitary rooms, handicraft and industrial firms) require slip-resistant floor coverings, e.g. consisting of glazed or unglazed vitreous or porcelain stoneware tiles with a slightly rough, rough or profiled surface. When small-format tiles are used, the high proportion of joints has a positive effect on the degree of slip resistance.

Slip-resistant coverings in publicly accessible areas are distinguished according to those that are walked over barefoot or in footwear. No rules have been issued to date with regard to areas for private use – such as in private bathrooms and kitchens or guest rooms and their bathrooms in hotels. When installing floor-flush showers, the use of tiles with slip-resistance for barefoot areas is recommended. Sanitary areas designed for accessibility are governed by the requirements under DIN 18040-1 in public buildings and DIN 18040-2 in private homes.

The requirements stipulated by the slip resistance are defined in the regulations mentioned below.

With our slip-resistant tiles, you will find the symbols

- slip resistance in commercial areas,
- slip resistance in barefoot areas and information about the relevant classification groups.

TRITTSICHERHEIT/RUTSCHHEMMUNG

DIN EN 16165:2021-12

Bestimmung der Rutschhemmung von Fußböden - Ermittlungsverfahren

Im Rahmen der Überarbeitung der länderspezifischen Normen wurde im Dezember 2021 mit der DIN EN 16165 eine europäische Norm erarbeitet, die Messverfahren zur Rutschhemmung von Bodenbelägen vereinheitlicht und für alle europäischen Länder verbindlich macht.

Trittsicherheit von Bodenfliesen

Nach der „EU-Bauprodukteverordnung Nr. 305/2011“ (EU-BauPVO) müssen Bodenbeläge nutzungssicher sein. Dies erfordert in verschiedenen Bereichen, in denen Unfallgefahr zu vermuten ist, die Einhaltung besonderer Anforderungen. Diese wurden von dem Ausschuss für Arbeitsstätten (ASTA) erarbeitet und in Form von technischen Regeln veröffentlicht. Zu diesen Anforderungen gehören auch solche an die Rutschhemmung - Merkblatt ASR A1.5 Technische Regeln für Arbeitsstätten - Fußböden, aktuelle Fassung März 2022 (ehemals BGR/GUV-R 181, bzw. DGUV Regel 108-003 für gewerblich genutzte Bereiche) und für Barfußbereiche das Merkblatt - „DGUV Information 207-006 - Bodenbeläge für nassbelastete Barfußbereiche“ (bisher BGI/GUV-I 8527, aktualisierte Fassung Mai 2020), der Deutschen Gesetzlichen Unfallversicherung (DGUV). Diese beiden Werke dienen als Grundlage und werden auch für weitere Nutzungsbereiche herangezogen.

Bereiche mit Rutschgefahr (z.B. Verkehrsflächen in öffentlichen Gebäuden, Geschäftsräume des Einzel- und Großhandels, Schwimmbäder, Sanitärräume, Handwerks-



Prüfverfahren

- Prüfung durch barfußiges Begehen einer schiefen Ebene
- Prüfung durch beschuhtes Begehen einer schiefen Ebene
- Pendelprüfung
- Tribometer-Prüfung

und Industriebetriebe) erfordern rutschhemmende Bodenbeläge, wie z.B. aus glasierten oder unglasierten Steinzeug- und Feinsteinzeugfliesen mit feinrauer, rauer oder profilierter Oberfläche. Bei kleinformatigen Fliesen wirkt sich der hohe Fugenteil hinsichtlich des Grades der Rutschhemmung positiv aus.

Man unterscheidet bei rutschhemmenden Belägen in öffentlich zugänglichen Bereichen nach solchen, die Barfuß oder mit Schuhwerk begangen werden. Nicht geregelt ist bisher der privat genutzte Bereich, wie z.B. in privaten Bädern und Küchen oder Gästezimmer und deren Bäder in Hotels. Beim Einbau von bodengleichen Duschen wird die Verwendung einer Fliese mit Rutschhemmung für Barfuß-Bereich empfohlen. Für barrierefrei gestaltete Sanitärbereiche gelten die Anforderungen lt. DIN 18040-1 in öffentlichen Gebäuden und DIN 18040-2 in privaten Wohnungen.

Die Anforderungen an die Rutschhemmung sind in den nachstehend erwähnten Vorschriften definiert.

Bei unseren rutschhemmenden Fliesen finden Sie die Symbole  Rutschhemmung im gewerblichen Bereich,  Rutschhemmung im Barfuß - Bereich und Hinweise auf die entsprechenden Bewertungsgruppen.

SLIP RESISTANCE

Slip resistance properties in commercial applications

Responsible institutions:

Federal Institute for Occupational Health and Safety, Friedrich-Henkel-Weg 1-25, D-44149 Dortmund - www.baua.de
Main Association of Employers' Liability Insurance Associations, Alte Heerstraße 111, D-53757 Sankt Augustin - www.dguv.de

Area of application:

Floors in work rooms and work areas where there is a risk of slipping

Regulations:

„BGV Professional Association regulations for occupational safety and health“ (Published by: Main Association of Employers' Liability Insurance Associations) Leaflet „ASR A1.5 - Technical Regulations for workplaces - Floors“ (Published by: Federal Institute for Occupational Health and Safety, Committee for workplaces - ASTA)

Test method:

DIN EN 16165 Annex B
Determination of slip resistance of pedestrian surfaces - Methods of evaluation.
DIN EN 16165 combines, inter alia, the test methods pursuant to DIN 51130 (R classes), DIN 51097 (A-B-C classes) and DIN 51131 (coefficient of sliding friction μ). The DIN standards have been withdrawn but are retained as test methods and are described in DIN EN 16165.

Walking method:

inclined plane

Assessment groups:

angle of inclination

	Lower limit value	Upper limit value
R9	6°	10°
R10	> 10°	19°
R11	> 19°	27°
R12	> 27°	35°
R13	> 35°	



R9: 6° – 10°	R10: 10° – 19°	R11: 19° – 27°	R12: 27° – 35°	R13: > 35°
------------------------	--------------------------	--------------------------	--------------------------	----------------------

The slip resistance of tiles is tested on an inclined plane with a predetermined angle of inclination and classified according to rating groups R9 to R13.

TRITTSICHERHEIT/RUTSCHHEMMUNG

▣ Trittsicherheitseigenschaften in gewerblichen Bereichen

Zuständige Institutionen:

Bundesanstalt für Arbeitsschutz und Arbeitsmedizin, Friedrich-Henkel-Weg 1-25, D-44149 Dortmund - www.baua.de
Hauptverband der gewerblichen Berufsgenossenschaften, Alte Heerstraße 111, D-53757 Sankt Augustin - www.dguv.de

Geltungsbereich:

Fußböden in Arbeitsräumen und Arbeitsbereichen mit Rutschgefahr

Vorschriften:

„BGV Berufsgenossenschaftliche Vorschriften für Arbeitssicherheit und Gesundheitsschutz“ (Herausgeber: Hauptverband der gewerblichen Berufsgenossenschaften)
„Merkblatt - ASR A1.5 - Technische Regeln für Arbeitsstätten - Fußböden“ (Herausgeber: Bundesanstalt für Arbeitsschutz und Arbeitsmedizin, Ausschuss für Arbeitsstätten - ASTA)

Prüfverfahren:

DIN EN 16165 Anhang B

Bestimmung der Rutschhemmung von Fußböden - Ermittlungsverfahren.

In der DIN EN 16165 wurden u.a. die Prüfmethode nach DIN 51130 (R-Klassen), DIN 51097 (A-B-C Klassen) und DIN 51131 (Gleitreibungskoeffizient μ) zusammengefasst. Die DIN Normen wurden zurück gezogen, bleiben aber als Prüfverfahren erhalten und werden in der DIN EN 16165 beschrieben.

Begehungsverfahren:

Schiefe Ebene

Bewertungsgruppen:

Neigungswinkel

	unterer Grenzwert	oberer Grenzwert
R9	6°	10°
R10	> 10°	19°
R11	> 19°	27°
R12	> 27°	35°
R13	> 35°	



R9: 6° – 10° **R10:** 10° – 19° **R11:** 19° – 27° **R12:** 27° – 35° **R13:** > 35°

Die Rutschhemmung von Fliesen wird auf einer schiefen Ebene mit entsprechendem Neigungswinkel getestet und Bewertungsgruppen von R9 bis R13 zugeordnet.

SLIP RESISTANCE

Working rooms and areas with risk of slipping in accordance with ASR A1.5

(Technical Regulations for Workplaces, March 2022 issue)

Working rooms and areas are classified according to five assessment groups based on the magnitude of the risk of slipping. Coverings in group R9 are subject to the lowest requirements, while the most stringent requirements apply to group R13 coverings. Working rooms and areas where a displacement space is necessary under the tread level in order to discharge substances that are particularly conducive to slipping are indicated by a „V“ in conjunction with a number specifying the minimum volume of the displacement space.

Designation of displacement space	Minimum volume of the displacement space below the walking area
V4	4 cm ³ /dm ²
V6	6 cm ³ /dm ²
V8	8 cm ³ /dm ²
V10	10 cm ³ /dm ²

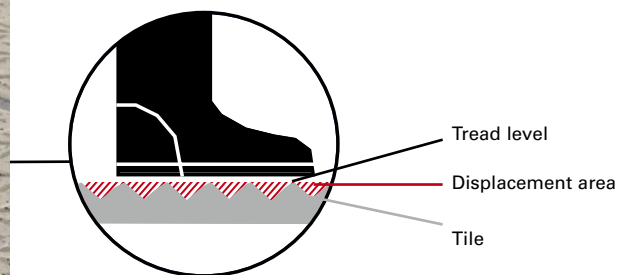
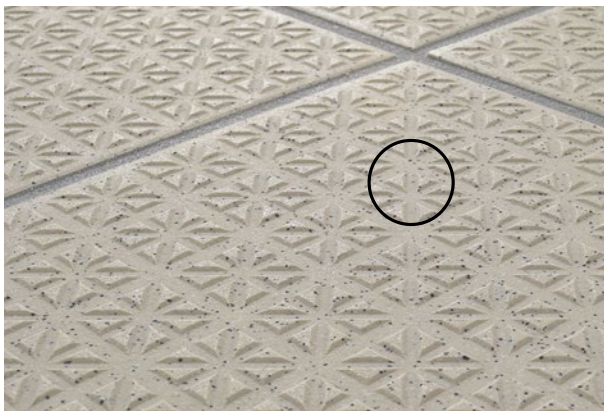

The displacement area is the cavity (marked red) between the raised sections of the tile beneath the tread level.

Working rooms and areas with risk of slipping in accordance with ASR A1.5

No.	Working rooms and traffic routes	Slipping risk assessment group (standard guideline)	Displacement area with number specifying minimum volume
0	General working rooms and areas *)		
0.1	Entrance areas, indoors **)	R9	
0.2	Entrance areas, outdoors	R11 or R10	V4
0.3	Stairs, indoors ***)	R9	
0.4	Stairs, outdoors	R11 or R10	V4
0.5	Sloping ramps, indoors ***) (for inclines of 3% or more; wheelchair ramps, compensating slopes, one R group higher than for the V value of the access flooring, transport routes)	One R-group higher necessary for the entrance covering	V-value of entrance, covering, where applicable
0.6	Sanitary rooms		
0.6.1	Toilets	R9	
0.6.2	Changing or washrooms	R10	
0.7	Break rooms (e.g. day rooms, canteens)	R9	
0.8	First aid rooms and similar facilities (see ASR A4.3)	R9	
1	Manufacture of margarine, edible fats and oils		
1.1	Fat melting	R13	V6
1.2	Edible-oil refinery	R13	V4
1.3	Manufacture and packing of margarine	R12	
1.4	Manufacture and packing of edible fat, bottling of edible oil	R12	
2	Milk treatment and processing, cheese production		
2.1	Processing of fresh milk, including buttery	R12	
2.2	Cheese production, storage and packing	R11	
2.3	Ice cream manufacture	R12	
3	Manufacture of chocolates and confectionery		
3.1	Sugar boiling plant	R12	
3.2	Cocoa production	R12	
3.3	Preparation of raw mass	R11	
3.4	Production of slabs, hollow moulded forms and chocolates	R11	
4	Manufacture of breads and pastries (bakeries, cake and biscuit manufacturers)		
4.1	Preparation of dough	R11	
4.2	Areas where fats and liquid mixtures are processed	R12	
4.3	Washing-up rooms	R12	V4
5	Slaughtering, meat handling, meat processing		
5.1	Abattoir	R13	V10
5.2	Gut cleaning areas	R13	V10
5.3	Meat jointing	R13	V8
5.4	Sausage and cold meats kitchen	R13	V8
5.5	Boiled sausage area	R13	V8
5.6	Preserved sausage area	R13	V6
5.7	Sausage drying room	R12	
5.8	Gut storage	R12	
5.9	Curing, smoking room	R12	
5.10	Poultry processing	R12	V6
5.11	Slicing and packing area	R12	

TRITTSICHERHEIT/RUTSCHHEMMUNG

Arbeitsräume und Arbeitsbereiche mit Rutschgefahr nach ASR A1.5

(Technische Regeln für Arbeitsstätten - Fußböden, Ausgabe März 2022)

Die Arbeitsräume und -bereiche sind entsprechend Rutschgefahr fünf Bewertungsgruppen zugeordnet. Für Beläge der Gruppe R9 gelten die geringsten, für Beläge der Gruppe R13 die höchsten Anforderungen. Die Arbeitsräume und -bereiche, in denen wegen des Anfalls besonderer gleitfördernder Stoffe ein Verdrängungsraum unterhalb der Gehebene erforderlich ist, sind durch ein "V" in Verbindung mit der Kennzahl für das Mindestvolumen des Verdrängungsraumes gekennzeichnet.

Bezeichnung des Verdrängungsraumes	Mindestvolumen unterhalb der Gehebene
V4	4 cm ³ /dm ²
V6	6 cm ³ /dm ²
V8	8 cm ³ /dm ²
V10	10 cm ³ /dm ²

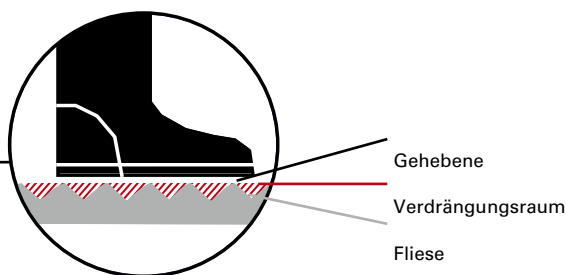
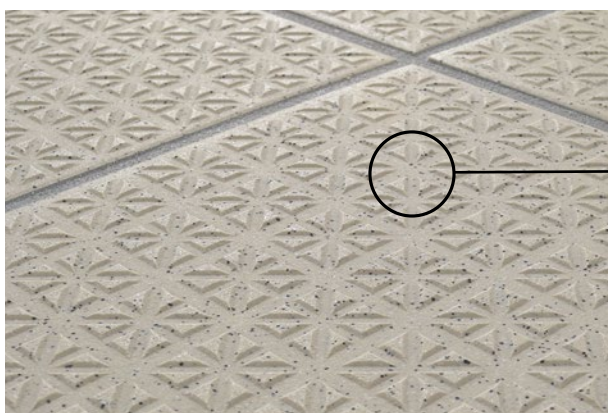

Der Verdrängungsraum ist der rot gekennzeichnete Hohlraum zwischen den Erhebungen der Fliese unterhalb der Gehebene

Arbeitsräume und Arbeitsbereiche mit Rutschgefahr nach ASR A1.5

Nr.	Arbeitsräume, -bereiche und betriebliche Verkehrswege	Bewertungsgruppe der Rutschgefahr (R-Gruppe)	Verdrängungsraum mit Kennzahl für das Mindestvolumen
0	Allgemeine Arbeitsräume und Arbeitsbereiche *)		
0.1	Eingangsbereiche – innen **)	R9	
0.2	Eingangsbereiche – außen	R11 oder R10	V4
0.3	Treppen – innen ***)	R9	
0.4	Außentreppen	R11 oder R10	V4
0.5	Schrägrampen, innen ***) (ab 3 % Steigung; z.B. Rollstuhlrampen, Ausgleichsschragen, Transportwege	Eine R-Gruppe höher als für den Zugangsbelag erforderlich	V-Wert des Zugangsbelags, falls zutreffend
0.6	Sanitärräume		
0.6.1	Toilettenräume	R9	
0.6.2	Umkleide- und Waschräume	R10	
0.7	Pausenräume (z.B. Aufenthaltsraum, Betriebskantinen)	R9	
0.8	Erste-Hilfe-Räume und vergleichbare Einrichtungen (siehe ASR A4.3)	R9	
1	Herstellung von Margarine, Speisefett, Speiseöl		
1.1	Fettschmelzen	R13	V6
1.2	Speiseölraffinerie	R13	V4
1.3	Herstellung und Verpackung von Margarine	R12	
1.4	Herstellung und Verpackung von Speisefett, Abfüllen von Speiseöl	R12	
2	Milchbe- und -verarbeitung, Käseherstellung		
2.1	Frischmilchverarbeitung einschl. Buttereie	R12	
2.2	Käsefertigung, -lagerung und Verpackung	R11	
2.3	Speiseeisfabrikation	R12	
3	Schokoladen- und Süßwarenherstellung		
3.1	Zuckerkochei	R12	
3.2	Kakaoherstellung	R12	
3.3	Rohmassenherstellung	R11	
3.4	Eintafelei, Hohlkörper- und Pralinenfabrikation	R11	
4	Herstellung von Backwaren (Bäckerei, Konditoreien, Dauerbackwaren- Herstellung)		
4.1	Teigbereitung	R11	
4.2	Räume, in denen vorwiegend Fette oder flüssige Massen verarbeitet werden	R12	
4.3	Spülräume	R12	V4
5	Schlachtung, Fleischbearbeitung, Fleischverarbeitung		
5.1	Schlachthaus	R13	V10
5.2	Kuttleraum, Darmschleimerei	R13	V10
5.3	Fleischzerlegung	R13	V8
5.4	Wurstküche	R13	V8
5.5	Kochwurstabteilung	R13	V8
5.6	Rohwurstabteilung	R13	V6
5.7	Wursttrockenraum	R12	
5.8	Darmlager	R12	
5.9	Pökelei, Räucherei	R12	
5.10	Geflügelverarbeitung	R12	V6
5.11	Aufschnitt- und Verpackungsabteilung	R12	
5.12	Handwerksbetrieb mit Verkauf	R12	V8 ****)

SLIP RESISTANCE

Working rooms and areas with risk of slipping in accordance with ASR A1.5

No.	Working rooms and traffic routes	Slipping risk assessment group (standard guideline)	Displacement area with number specifying minimum volume
5.12	Butchery with shop	R12	V8****)
6	Handling and processing of fish, manufacture of delicatessen products		
6.1	Handling and processing of fish	R13	V10
6.2	Manufacture of delicatessen products	R13	V6
6.3	Manufacture of mayonnaise	R13	V4
7	Preparation and processing of vegetables		
7.1	Manufacture of sauerkraut	R13	V6
7.2	Manufacture of canned vegetables	R13	V6
7.3	Sterilisation areas	R11	
7.4	Rooms in which vegetables are prepared for processing.	R12	V4
8	Wet areas in food and drink manufacture (if not specifically mentioned)		
8.1	Storage and fermenting cellar	R10	
8.2	Bottling, fruit juice manufacture	R11	
9	Kitchens, dining rooms		
9.1	Gastronomic kitchens (restaurant and hotel kitchens)	R12	
9.2	Commercial kitchens in homes, schools, day nurseries, sanatoriums	R11	
9.3	Commercial kitchens in hospitals and clinics	R12	
9.4	Large-scale commercial kitchens in canteens, district kitchens	R12	
9.5	Fast food kitchens, convenience food outlets and snack bars	R12	
9.6	Defrosting and re-heating kitchens	R10	
9.7	Tea and coffee kitchens, B+B kitchens, ward kitchens	R10	
9.8	Washing-up areas		
9.8.1	Washing-up areas for 9.1, 9.4, 9.5	R12	V4
9.8.2	Washing-up areas for 9.2	R11	
9.8.3	Washing-up areas for 9.3	R12	
9.9	Dining rooms, guest rooms, canteens incl. serving areas	R9	
9.10	Counter area, cabinet area	R10	
10	Cold storage rooms, deep freeze rooms and depots		
10.1	For non-packaged goods	R12	
10.2	For packaged goods	R11	
11	Sales areas and shops		
11.1	Receiving room for meats		
11.1.1	For unpackaged goods (e.g. loose in transport boxes)	R11	
11.1.2	For packaged goods	R10	
11.2	Receiving room for fish	R11	
11.3	Serving area for meats and cold cuts		
11.3.1	For non-packaged goods	R11	
11.3.2	For packaged goods	R10	
11.4	Serving area for breads and pastries, non-packaged goods	R10	
11.5	Serving area for dairy and delicatessen products, non-packaged goods	R10	
11.6	Serving area for fish		
11.6.1	For non-packaged goods	R12	
11.6.2	For packaged goods	R11	
11.7	Serving areas other than 11.3 – 11.6	R9	
11.8	Meat preparation room		
11.8.1	For meat preparation other than covered in 5.	R12	V8
11.8.2	For meat processing other than covered in 5.	R11	
11.9	Flower arranging rooms and areas	R11	
11.10	Sales areas with fixed ovens		
11.10.1	For the production of breads and pastries	R11	
11.10.2	For the baking of prepared breads and pastries	R10	
11.11	Sales areas with fixed deep-fat fryers or grills	R12	V4
11.12	Sales areas, customer-frequented areas	R9	
11.13	Preparation areas for food for self-service sale	R10	
11.14	Cash till, packing areas	R9	
11.15	Sales areas outdoors	R11 or R10	V4
12	Public health service rooms		
12.1	Disinfection areas (wet)	R11	
12.2	Sterilisation areas	R10	
12.3	Excrement areas, sink rooms, unclean nursing rooms	R10	
12.4	Pathology rooms	R10	
12.5	Rooms for medicinal baths, hydrotherapy, fango preparation	R11	
12.6	Washrooms for operating theatres, plaster casting rooms	R10	
12.7	Sanitary rooms, ward bathrooms	R10	
12.8	Rooms for medical diagnosis and therapy, massaging rooms	R9	
12.9	Operating theatres	R9	
12.10	Wards with hospital rooms and corridors	R9	
12.11	Medical practices, day clinics	R9	
12.12	Dispensing chemist's	R9	
12.13	Laboratories	R9	
12.14	Hairdresser's	R9	
13	Laundries		
13.1	Rooms with continuous-run washing machines or centrifugal washing machines	R9	
13.2	Rooms in which the laundry is removed from the machine dripping wet	R11	
13.3	Rooms for ironing and pressing	R9	
14	Feed concentrate production		
14.1	Dry feed production	R11	
14.2	Feed concentrate production using fat and water	R11	V4
15	Manufacture of leather goods, textiles		
15.1	Water workshops in tanneries	R13	
15.2	Areas with fleshing machines	R13	V10
15.3	Areas where glued leather occurs	R13	V10
15.4	Grease room for the manufacture of seals	R12	
15.5	Dye works for textiles	R11	
16	Paint-shops		
16.1	Wet rubbing down areas	R12	V10
16.2	Powder coating	R11	
16.3	Paint finish	R10	
17	Ceramics industry		
17.1	Wet-grinding (for ceramic material)	R11	
17.2	Mixers, working with materials such as tar, pitch, graphite, synthetic resins	R11	V6
17.3	Presses (Forming), working with materials such as tar, pitch, graphite, synthetic resin	R11	V6
17.4	Casting / die Casting areas	R12	
17.5	Glazing areas	R12	

TRITTSICHERHEIT/RUTSCHHEMMUNG

Arbeitsräume und Arbeitsbereiche mit Rutschgefahr nach ASR A1.5

Nr.	Arbeitsräume, -bereiche und betriebliche Verkehrswege	Bewertungsgruppe der Rutschgefahr (R-Gruppe)	Verdrängungsraum mit Kennzahl für das Mindestvolumen
6	Be- und Verarbeitung von Fisch, Feinkostherstellung		
6.1	Be- und Verarbeitung von Fisch	R13	V10
6.2	Feinkostherstellung	R13	V6
6.3	Mayonnaiseherstellung	R13	V4
7	Gemüsebe- und -verarbeitung		
7.1	Sauerkrautherstellung	R13	V6
7.2	Gemüsekonservenherstellung	R13	V6
7.3	Sterilisierräume	R11	
7.4	Räume, in denen Gemüse für die Verarbeitung vorbereitet wird	R12	V4
8	Nassbereiche bei der Nahrungsmittel- und Getränkeherstellung (soweit nicht besonders erwähnt)		
8.1	Lagerkeller, Garkeller	R10	
8.2	Getränkeabfüllung, Fruchtsaftherstellung	R11	
9	Küchen, Speiseräume		
9.1	Gastronomische Küchen (Gaststättenküchen, Hotelküchen)	R12	
9.2	Küchen für Gemeinschaftsverpflegung in Heimen, Schulen, Kindertageseinrichtungen, Sanatorien	R11	
9.3	Küchen für Gemeinschaftsverpflegung in Krankenhäusern, Kliniken	R12	
9.4	Großküchen für Gemeinschaftsverpflegung in Mensen, Kantinen, Fernküchen	R12	
9.5	Aufbereitungsküchen (Fast-Food-Küchen, Convenience- und Imbissbetriebe)	R12	
9.6	Auftau- und Aufwärmküchen	R10	
9.7	Kaffee- und Teeküchen, Küchen in Hotels-Garni, Stationsküchen	R10	
9.8	Spülräume		
9.8.1	Spülräume zu 9.1, 9.4, 9.5	R12	V4
9.8.2	Spülräume zu 9.2	R11	
9.8.3	Spülräume zu 9.3	R12	
9.9	Speiseräume, Gasträume, Kantinen, einschließlich Serviergängen	R9	
9.10	Thekenbereich, Schankbereich	R10	
10	Kühlräume, Tiefkühlräume, Kühlhäuser, Tiefkühlhäuser		
10.1	Für unverpackte Ware	R12	
10.2	Für verpackte Ware	R11	
11	Verkaufsstellen, Verkaufsräume		
11.1	Warenannahme Fleisch		
11.1.1	Für unverpackte Ware (z. B. lose in Transportboxen)	R11	
11.1.2	Für verpackte Ware	R10	
11.2	Warenannahme Fisch	R11	
11.3	Bedienungsgang für Fleisch und Wurst		
11.3.1	Für unverpackte Ware	R11	
11.3.2	Für verpackte Ware	R10	
11.4	Bedienungsgang für Brot und Backwaren, unverpackte Ware	R10	
11.5	Bedienungsgang für Molkerei- und Feinkosterzeugnisse, unverpackte Ware	R10	
11.6	Bedienungsgang für Fisch		
11.6.1	Für unverpackte Ware	R12	
11.6.2	Für verpackte Ware	R11	
11.7	Bedienungsgänge, ausgenommen Nr. 11.3 bis 11.6	R9	
11.8	Fleischvorbereitungsraum		
11.8.1	Zur Fleischbearbeitung, ausgenommen Nr. 5	R12	V8
11.8.2	Zur Fleischverarbeitung, ausgenommen Nr. 5	R11	
11.9	Blumenbinderäume und -bereiche	R11	
11.10	Verkaufsbereiche mit ortsfesten Backöfen		
11.10.1	Zum Herstellen von Backwaren	R11	
11.10.2	Zum Aufbacken vorgefertigter Backwaren	R10	
11.11	Verkaufsbereiche mit ortsfesten Friteusen oder ortsfesten Grillanlagen	R12	V4
11.12	Verkaufsräume, Kundenräume	R9	
11.13	Vorbereitungsbereiche für Lebensmittel zum SB-Verkauf	R10	
11.14	Kassenbereiche, Packbereiche	R9	
11.15	Verkaufsbereiche im Freien	R11 oder R10	V4
12	Räume des Gesundheitsdienstes / der Wohlfahrtspflege		
12.1	Desinfektionsräume (nass)	R11	
12.2	Vorreinigungsbereiche der Sterilisation	R10	
12.3	Fäkalienräume, Ausgussräume, unreine Pflegearbeitsräume	R10	
12.4	Sektionsräume	R10	
12.5	Räume für medizin. Bäder, Hydrotherapie, Fango-Aufber.	R11	
12.6	Waschräume von OP's, Gipsräume	R10	
12.7	Sanitäre Räume, Stationsbäder	R10	
12.8	Räume für medizinische Diagnostik und Therapie, Massageräume	R9	
12.9	OP-Räume	R9	
12.10	Stationen mir Krankenzimmern und Flure	R9	
12.11	Praxen der Medizin, Tageskliniken	R9	
12.12	Apotheken	R9	
12.13	Laborräume	R9	
12.14	Friseursalons	R9	
13	Wäscherei		
13.1	Räume mit Durchlaufwaschmaschinen (Waschröhren) oder mit Waschscheudermaschinen	R9	
13.2	Räume mit Waschmaschinen, bei denen die Wäsche tropfnass entnommen wird	R11	
13.3	Räume zum Bügeln und Mangeln	R9	
14	Kraftfutterherstellung		
14.1	Trockenfutterherstellung	R11	
14.2	Kraftfutterherstellung unter Verwendung von Fett und Wasser	R11	V4
15	Lederherstellung, Textilien		
15.1	Wasserwerkstatt in Gerbereien	R13	
15.2	Räume mit Entfleischmaschinen	R13	V10
15.3	Räume mit Leimlederanfall	R13	V10
15.4	Fetträume für Dichtungsherstellung	R12	
15.5	Färbereien für Textilien	R11	
16	Lackierereien		
16.1	Nassschleifbereiche	R12	V10
16.2	Pulverbeschichtung	R11	
16.3	Lackierung	R10	
17	Keramische Industrie		
17.1	Nassmühlen (Aufbereitung keramischer Rohstoffe)	R11	
17.2	Mischer		
17.3	Umgang mit Stoffen, wie Teer, Pech, Graphit, Kunstharzen	R11	V6
17.3	Pressen (Formgebung)		
17.4	Umgang mit Stoffen, wie Teer, Pech, Graphit, Kunstharzen	R11	V6
17.4	Gieß-, Druckgussbereiche	R12	
17.5	Glasierbereiche	R12	

SLIP RESISTANCE

Working rooms and areas with risk of slipping in accordance with ASR A1.5

No.	Working rooms and traffic routes	Slipping risk assessment group (standard guideline)	Displacement area with number specifying minimum volume
18	Treatment and processing of glass and stone		
18.1	Stone cutting, stone grinding areas	R11	
18.2	Glass moulding of hollow glass, container glass, structural glass	R11	
18.3	Grinding areas for hollow glass, sheet glass	R11	
18.4	Processing of insulating glass Working with desiccants	R11	V6
18.5	Packaging, dispatch of sheet glass, Working with anti-blocking agents	R11	V6
18.6	Etching and acid polishing units for glass	R11	
19	Cement works		
19.1	Cement washing area	R11	
20	Storage rooms		
20.1	Storage rooms for oils and fats, intended for partial removal (e.g. in workshops)	R12	V6
20.2	Storage rooms for packaged foods	R10	
20.3	Storage rooms outdoors	R11 or R10	V4
21	Chemical and thermal treatment of iron, metal and glass		
21.1	Pickling shops	R12	
21.2	Hardening shops	R12	
21.3	Laboratories	R11	
22	Metal workshops		
22.1	Electroplating rooms	R12	
22.2	Grey iron processing	R11	V4
22.3	Mechanical processing areas (e.g. lathe shop, milling shop), punching department, pressroom, drawing mill (pipes, wires)	R11	
22.4	Mechanical processing areas with increased use of oil and lubricating materials	R11	V4
22.5	Part cleaning areas, steaming areas	R12	
23	Vehicle maintenance workshop		
23.1	Repair and maintenance shop	R11	
23.2	Repair and inspection pit	R12	V4
23.3	Car wash, washing areas	R11	V4
24	Aircraft maintenance workshops		
24.1	Hangars	R11	
24.2	Repair hangars	R12	
24.3	Washing areas	R11	V4
25	Sewage works		
25.1	Pumping rooms	R12	
25.2	Rooms for sludge de-watering facilities	R12	
25.3	Rooms for raking facilities	R12	
25.4	Standing areas of workplaces, working and maintenance platforms	R12	
26	Fire stations		
26.1	Vehicle standing areas	R12	
26.2	Rooms for hose servicing equipment	R12	
27	Functional rooms in the breathing apparatus training facility		
27.1	Preparation room	R10	
27.2	Conditioning room	R10	
27.3	Training room	R11	
27.4	Air lock	R10	
27.5	Mock-up dwelling	R11	
27.6	Heat acclimatisation room	R11	
27.7	Control station	R9	
28	Schools and day nurseries		
28.1	Entrance areas, corridors, recreation halls	R9	
28.2	Classrooms, group rooms	R9	
28.3	Stairs	R9	
28.4	Toilets, washrooms	R10	
28.5	Cookery rooms in schools (See no. 9.2, 9.6 or 9.7)		
28.6	Kitchens in day nurseries (See see also Item 9)	R10	
28.7	Machine rooms for woodwork	R10	
28.8	Special rooms for woodwork etc.	R10	
28.9	Playgrounds	R11 or R10	V4
29	Banks		
29.1	Bank counter areas	R9	
30	Outside traffic routes		
30.1	Paths	R11 or R10	V4
30.2	Loading ramps covered	R11 or R10	V4
30.2.1	covered	R11 or R10	V4
30.2.2	not covered	R12 or R11	V4
30.3	Sloping ramps (from 3% incline; e.g. for wheelchairs, loading ramps)	R12 or R11	V4
30.4	Refuelling areas		
30.4.1	covered	R11	
30.4.2	not covered	R12	
31	Parking areas		
31.1	Garages, multi-storey and underground car parks not subject to the effects of the weather *****	R10	
31.2	Garages, multi-storey and underground car parks subject to the effects of the weather	R11 or R10	V4
31.3	Parking areas outdoors	R11 or R10	V4
32	Bathrooms		
32.1	Individual and group changing rooms with lockers	R10	
32.2	Sauna and relaxation areas	R10	
32.3	Shower rooms and shower areas	R10	
32.4	Pool surrounds	R10	

*) for floors in wet barefoot areas see GUV information 'Bodenbeläge für nassbelastete Barfußbereiche' (DGUV Information 207-006)

**) Entrance areas in accordance with number 0.1 are areas accessed directly from outside and that may be wet if conditions are wet outside (see also Item 6, paragraph 3, use of mats to take up dirt and moisture). For adjacent areas or other large spaces, please observe Item 4 paragraph 10.

***) Stairs, ramps in accordance with number 0.3 and 0.5 are those that may be wet if it is wet outside. For adjacent areas, please see Item 4 paragraph 10.

****) If a uniform floor covering has been installed everywhere, on the basis of a hazard analysis (taking account of the cleaning method, the work flows and the amount of substances on the floor that are particularly conducive to slipping), the displacement area can be reduced to V4.

*****) Those pedestrian areas not affected by the risk of slipping as a result of the effects of the weather, such as driving rain or water that has been brought in from outside.

TRITTSICHERHEIT/RUTSCHHEMMUNG

Arbeitsräume und Arbeitsbereiche mit Rutschgefahr nach ASR A1.5

Nr.	Arbeitsräume, -bereiche und betriebliche Verkehrswege	Bewertungsgruppe der Rutschgefahr (R-Gruppe)	Verdrängungsraum mit Kennzahl für das Mindestvolumen
18	Be- und Verarbeitung von Glas und Stein		
18.1	Steinsägerei, Steinschleiferei	R11	
18.2	Glasformgebung von Hohlglas, Behälterglas, Bauglas	R11	
18.3	Schleifereibereiche für Hohlglas, Flachglas	R11	
18.4	Isolierglasfertigung – Umgang mit Trockenmittel	R11	V6
18.5	Verpackung, Versand von Flachglas, Umgang mit Antihafmittel	R11	V6
18.6	Ätz- und Säurepolieranlagen für Glas	R11	
19	Betonwerke		
19.1	Betonwaschplätze	R11	
20	Lagerbereiche		
20.1	Lagerräume für Öle und Fette, die zur Teilentnahme vorgesehen sind (z. B. in Werkstätten)	R12	V6
20.2	Lagerräume für verpackte Lebensmittel	R10	
20.3	Lagerbereiche im Freien	R11 oder R10	V4
21	Chemische und thermische Behandlung von Eisen und Metall		
21.1	Beizereien	R12	
21.2	Härtereien	R12	
21.3	Laborräume	R11	
22	Metallbe- und -verarbeitung, Metall-Werkstätten		
22.1	Galvanisierungsräume	R12	
22.2	Graugussbearbeitung	R11	V4
22.3	mechanische Bearbeitungsbereiche (z.B. Dreherei, Fräserei), Stanzerei, Presserei, Zieherei (Rohre, Drähte)	R11	
22.4	mechanische Bearbeitungsbereiche mit erhöhter Öl-Schmiermittelbelastung	R11	V4
22.5	Teileriegnungsbereiche, Abdämpfungsbereiche	R12	
23	Werkstätten für Fahrzeug-Instandhaltung		
23.1	Instandsetzungs- und Wartungsräume	R11	
23.2	Arbeits- und Prüfgrube	R12	V4
23.3	Waschhalle, Waschplätze	R11	V4
24	Werkstätten für das Instandhalten von Luftfahrzeugen		
24.1	Flugzeughallen	R11	
24.2	Werfthallen	R12	
24.3	Waschplätze	R11	V4
25	Abwasserbehandlungsanlagen		
25.1	Pumpenräume	R12	
25.2	Räume für Schlammmentwässerungsanlagen	R12	
25.3	Räume für Rechenanlagen	R12	
25.4	Standplätze von Arbeitsplätzen, Arbeitsbühnen und Wartungspodeste	R12	
26	Feuerwehrrhäuser		
26.1	Fahrzeug-Stellplätze	R12	
26.2	Räume für Schlauchpflegeeinrichtungen	R12	
27	Funktionsräume in der Atemschutzübungsanlage		
27.1	Vorbereitungsraum	R10	
27.2	Konditionsraum	R10	
27.3	Übungsraum	R11	
27.4	Schleuse	R10	
27.5	Zielraum	R11	
27.6	Wärmegewöhnungsraum	R11	
27.7	Leitstand	R9	
28	Schulen und Kindertageseinrichtungen		
28.1	Eingangsbereiche, Flure, Pausenhallen	R9	
28.2	Unterrichtsräume, Gruppenräume	R9	
28.3	Treppen	R9	
28.4	Toilettenräume, Waschräume	R10	
28.5	Lehrküchen in Schulen (siehe Nummer 9.2, 9.6 oder 9.7)		
28.6	Küchen in Kindertageseinrichtungen (siehe auch Nummer 9)	R10	
28.7	Maschinenräume für Holzbearbeitung	R10	
28.8	Fachräume für Werken	R10	
28.9	Pausenhöfe	R11 oder R10	V4
29	Geldinstitute		
29.1	Schalterräume	R9	
30	Betriebliche Verkehrswege in Außenbereichen		
30.1	Gehwege	R11 oder R10	V4
30.2	Laderampen		
30.2.1	Überdacht	R11 oder R10	V4
30.2.2	Nicht überdacht	R12	V4
30.3	Schrägrampen (ab 3 % Steigung; z.B. für Rollstühle, Ladebrücken)	oder R11 R12 oder R11	V4
30.4	Betankungsbereiche		
30.4.1	überdacht	R11	
30.4.2	nicht überdacht	R12	
31	Parkbereiche		
31.1	Garagen, Hoch- und Tiefgar. ohne Witterungseinfluss *****)	R10	
31.2	Garagen, Hoch- und Tiefgaragen mit Witterungseinfluss	R11 oder R10	V4
31.3	Parkflächen im Freien	R11 oder R10	V4
32	Bäder		
32.1	Einzel- und Sammelumkleideräume	R10	
32.2	Sauna- und Ruhebereiche	R10	
32.3	Duschräume und Duschbereiche	R10	
32.4	Beckenumgänge	R10	

*) für Fußböden in barfuß begangenen Nassbereichen siehe DGUV Information „Bodenbeläge für nassbelastete Barfußbereiche“ (DGUV Information 207-006)

**) Eingangsbereiche gemäß Nummer 0.1 sind die Bereiche, die durch Eingänge direkt aus dem Freien betreten werden und in die Feuchtigkeit von außen hereingetragen werden kann (siehe auch Abschnitt 6 Absatz 3, Verwendung von Schmutz- und Feuchtigkeitsaufnehmern). Für anschließende Bereiche oder andere großflächige Räume ist Abschnitt 4 Absatz 10 zu beachten.

***) Treppen, Rampen gemäß Nummer 0.3 und 0.5 sind diejenigen, auf die Feuchtigkeit von außen hineingetragen werden kann. Für anschließende Bereiche ist Abschnitt 4 Absatz 10 zu beachten.

****) Wurde überall ein einheitlicher Bodenbelag verlegt, kann der Verdrängungsraum auf Grund einer Gefährdungsbeurteilung (unter Berücksichtigung des Reinigungsverfahrens, der Arbeitsabläufe und des Anfalls an gleitfördernden Stoffen auf den Fußboden) bis auf V 4 gesenkt werden.

*****) Die Fußgängerbereiche, die nicht von Rutschgefahr durch Witterungseinflüsse, wie Schlagregen oder eingeschleppte Nässe, betroffen sind.

SLIP RESISTANCE

Working rooms and areas with risk of slipping

Requirements for the safe installation of floors in workplaces are described in the “Technical Regulations for Workplaces (ASR)” ASR A1.5. They specify:

“Those areas that are normally in constant use should have a relatively homogenous slip resistance to prevent the risk of tripping or slipping. This could be the case if the slip resistance of the surfaces differs by more than one R group within a single floor (e.g. with coverings, markings or adhesive films) or adjacent floors”.

We also recommend compliance with the following excerpts from the BGR /GUV-R 181 and DGUV Rule 108-003 of the of the DGUV accident-insurance association (DGUV).

In connected work places with differing slip risks, where employees move from one work place to the other, the same floor covering of the higher classification group should be used for the entire area.

To facilitate cleaning, smooth, non-profiled floor coverings can be used in areas that cannot be walked on. This is the case, for example, along walls up to a distance of about 15 cm, in corners, in the case of lying cove bases and under machinery and equipment firmly anchored in the ground.

Such areas include, for example, along the walls up to a distance of 15 cm, in corners and under machines and installations which are firmly fixed to the floor.

A rounded edge between the walls and floor e.g. cove skirting is easier to clean than a rectangular edge.

This is particularly true of rooms with hazardous materials or biological agents, as part of an effort to prevent undetected accumulation of such materials.

Slip resistance in private areas

With regard to slip resistance, floor coverings in private areas are not subject to standard regulations. Independent of that, however, it is recommended to choose slip-resistant tiles according to your personal safety requirements.

In accessible residential construction, the requirements of DIN 18040-2 must be observed, particularly where floor-flush shower areas are concerned.

TRITTSICHERHEIT/RUTSCHHEMMUNG

Arbeitsräume und Arbeitsbereiche mit Rutschgefahr

Die Anforderungen für die sichere Ausführung von Fußböden in Arbeitsstätten werden in den „Technischen Regeln für Arbeitsstätten (ASR)“ ASR A1.5 beschrieben. Unter anderem heißt es hier:

„In Bereichen, die im Rahmen ihrer üblichen Nutzung durchgehend begangen werden müssen, dürfen sich die Fußbodenoberflächen hinsichtlich ihrer Rutschhemmung nicht so voneinander unterscheiden, dass es zu Stolper- und Rutschgefahren kommen kann. Dies kann gegeben sein, wenn sich die Oberflächenbeschaffenheiten innerhalb eines Fußbodens (z. B. bei Abdeckungen, Markierungen oder aufgeklebten Folien) oder von angrenzenden Fußböden hinsichtlich der Rutschhemmung um mehr als eine R-Gruppe unterscheiden“.

Wir empfehlen zusätzlich die Beachtung nachfolgender Auszüge aus der BGR /GUV-R 181 bzw. DGUV Regel 108-003 der Deutschen Gesetzlichen Unfallversicherung (DGUV): Benachbarte Arbeitsbereiche mit unterschiedlicher Rutschgefahr, in denen die Beschäftigten wechselweise tätig sind, sollten einheitlich mit demselben Bodenbelag der jeweils höheren Bewertungsgruppe ausgestattet werden. Fußböden dürfen keine Stolperstellen aufweisen.

Zur Erleichterung der Reinigung darf in Bereichen, die nicht betreten werden können, auch ein ebener und unprofiliertes Bodenbelag verlegt werden. Dies ist z.B. entlang der Wände bis zu einem Abstand von etwa 15 cm, in Ecken, bei liegenden Hohlkehlsokeln und unter fest im Boden verankerten Maschinen und Einrichtungen der Fall.

Gerundet ausgebildete Übergänge zwischen Fußböden und Wänden lassen sich durch die Verwendung von ausgerundeten Formteilen wie u.a. Kehlsokeln erfahrungsgemäß leichter reinigen, als rechtwinklig ausgeführte.

Dieses betrifft insbesondere Räume mit Gefahrstoffen oder biologischen Arbeitsstoffen damit ein unbemerktes Ansammeln derartiger Stoffe verhindert wird.

Trittsicherheit im Privatbereich

Hinsichtlich der Trittsicherheit unterliegen Bodenbeläge im Privatbereich keinen geregelten Vorgaben. Je nach persönlichem Sicherheitsbedürfnis empfiehlt es sich, eine trittsichere Fliese zu wählen.

Im barrierefreien Wohnungsbau sind die Anforderungen DIN 18040-2, insbesondere an bodengleiche Duschbereiche, zu beachten.

SLIP RESISTANCE

Slip-resistance properties in barefoot areas

Responsible institutions:

German Statutory Accident Insurance (DGUV),
Glinkastraße 40, D-10117 Berlin - www.dguv.de

Area of application:

Wet barefoot areas, e.g. in swimming pools, hospitals, as well as changing rooms, washrooms and showers in sports centres and workplaces for which the statutory accident insurance agencies are responsible.

Regulations:

Leaflet „DGUV Information 207-006 - Floor coverings for wet barefoot areas“ (previously BGI/GUV-I 8527, updated version of May 2020)
Published by: German Statutory Accident Insurance (DGUV)

Test method:



The test is conducted in accordance with DIN EN 16165
Determination of slip resistance of pedestrian surfaces -
Methods of evaluation

Walking method:

sloping plane
The slip resistance of tiles is tested on an inclined plane with a predetermined angle of inclination and classified according to rating groups A to C.

If barefoot areas are also to be walked over in footwear, the requirements of ASR A1.5 must also be observed.

Classification groups and areas of application:

Classification group	Lower limit value	Upper limit value	Areas
A 	12°	18°	Barefoot hallways and sanitary areas (mainly dry) Individual and group changing rooms with lockers Pool floors in the non-swimmer areas, where the water level exceeds 80 cm Sauna and relaxation areas (mainly dry)
B 	> 18°	24°	Barefoot hallways and sanitary areas, if not classified in A Showers and shower areas Steam baths Area surrounding the disinfectant sprayers Pool surrounds Pool floor in the non-swimmer areas, where the water level is less than 80 cm Pool floor in the non-swimmer areas in the tide effect pool Lift slab floors Paddling pools Steps and ladders outside the pool area provided these are not assigned to C Accessible surfaces of diving platforms and diving board installations which are not allocated to C Sauna and relaxation area, provided they are not assigned to A
C 	> 24°		Steps and ladders leading into the water Stairways leading to diving boards and water slides Surfaces of diving platforms and diving boards in the length which is reserved for the diver (the slip-resistant surface of the diving platforms and diving boards must lead around the front edge where it is gripped by users' hands and toes) Starting blocks Foot basins Inclined pool borders Kneipp pool, foot pool Ramps in the pool rim area with an inclination of > 6%

TRITTSICHERHEIT/RUTSCHHEMMUNG

■ Trittsicherheitseigenschaften in barfuß begangenen Bereichen

Zuständige Institution:

Deutsche Gesetzliche Unfallversicherung (DGUV),
Glinkastraße 40, D-10117 Berlin - www.dguv.de

Geltungsbereich:

Nassbelastete Barfußbereiche, z. B. in Bädern, Krankenhäusern sowie Umkleide-, Wasch- und Duschräumen von Sport- und Arbeitsstätten, für die die Träger der gesetzlichen Unfallversicherung zuständig sind.

Vorschriften:

Merkblatt „DGUV Information 207-006 - Bodenbeläge für nassbelastete Barfußbereiche“ (bisher BGI/GUV-I 8527, aktualisierte Fassung Mai 2020)
Herausgeber: Deutsche Gesetzliche Unfallversicherung (DGUV)

Prüfverfahren:



Die Prüfung erfolgt nach DIN EN 16165
Bestimmung der Rutschhemmung von Fußböden - Ermittlungsverfahren

Begehungsverfahren:

Schiefe Ebene.
Die Rutschhemmung von Fliesen wird auf einer schiefen Ebene mit entsprechendem Neigungswinkel getestet und Bewertungsgruppen von A bis C zugeordnet.

Werden Barfußbereiche planmäßig auch mit Schuhwerk begangen, sind zusätzlich die Anforderungen nach der ASR A1.5 zu beachten.

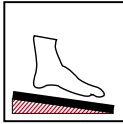
Bewertungsgruppen und Anwendungsbereiche:

Bewertungsgruppe	Unterer Grenzwert	Oberer Grenzwert	Bereiche
■ A 	12°	18°	Barfußgänge und Sanitärbereiche (weitgehend trocken) Einzel- und Sammelumkleideräume Beckenböden in Nichtschwimmerbereichen, wenn im gesamten Bereich die Wassertiefe mehr als 80 cm beträgt Sauna- und Ruhebereiche (weitgehend trocken)
■ B 	> 18°	24°	Barfußgänge und Sanitärbereiche, soweit sie nicht A zugeordnet sind Duschräume und Duschbereiche Dampfbäder Bereich von Desinfektionsprühanlagen Beckenumgänge Beckenböden in Nichtschwimmerbereichen, wenn in Teilbereichen die Wassertiefe weniger als 80 cm beträgt Beckenböden in Nichtschwimmerbereichen von Wellenbecken Hubböden Planschbecken Leitern und Treppen außerhalb des Beckenbereiches, soweit diese nicht C zugeordnet sind Begehbare Oberflächen von Sprungplattformen und Sprungbrettanlagen, soweit sie nicht C zugeordnet sind. Sauna- und Ruhebereich, soweit sie nicht A zugeordnet sind
■ C 	> 24°		Ins Wasser führende Leitern und Treppen Aufgänge zu Sprunganlagen und Wasserrutschen Oberflächen von Sprungplattformen und Sprungbrettern in der Länge, die für den Springer reserviert sind (Die rutschfeste Oberfläche der Sprungplattformen und Sprungbretter muss um die Vorderkante herumgeführt werden, wo die Hände und Zehen der Benutzer greifen. Startblöcke Durchschreitebecken Kneippbecken, Tretbecken Geneigte Beckenrandausbildung Rampen im Beckenumgangsbereich mit Neigung > 6%

TRIBOMETER TESTING

The tribometer (device for the measurement of wear, friction and lubrication) is fitted with glides and is pulled parallel to the surface of a floor covering at a constant speed. The force that this requires is evaluated over the length of the measuring section. To determine the coefficient of sliding friction (μ), this force is divided by the vertical force.

The test can be carried out in a wet state, in operating condition or in dry condition (original text from DIN 51131).

The tribometer test method can be used for all types of operating conditions and lubricants.

Der Tribometer (Gleitmessgerät) ist mit Gleitern ausgerüstet, und wird parallel zur Oberfläche eines Bodenbelags mit konstanter Geschwindigkeit gezogen. Die hierfür erforderliche Kraft wird über die Länge der Messstrecke ermittelt. Zur Ermittlung des Gleitreibungskoeffizienten (μ) wird diese Kraft durch die vertikal wirkende Kraft dividiert.

Die Prüfung kann im nassen Zustand, im Betriebszustand oder trocken durchgeführt werden (Originaltext aus DIN 51131).

Das Prüfverfahren mittels Tribometer kann für alle Arten von Betriebszuständen und Gleitmitteln verwendet werden.

Wert / Value (μ)	Verwendungsgruppe / Application group
0 - 0,14	VG1
0,15 - 0,29	VG2
0,30 - 0,43	VG3
0,44 - 0,57	VG4
0,58 - 0,68	VG5
0,69 - 1,0	VG6

ABERDEEN

Art.-Nr.	Farb-Nr. Colour code	Verwendungsgruppe / Application group
2846	SB10, SB60, SB70, SB90	VG5
2987	SB10, SB60, SB70, SB90	VG5
2577	SB10, SB60, SB70, SB90	VG5
2576	SB10, SB60, SB70, SB90	VG5
2988	SB10, SB60, SB70, SB90	VG5
2685	SB1M, SB6M, SB7M, SB9M	VG5
2526	SB1R, SB6R, SB7R, SB9R	VG5
2536	SB1V, SB6V, SB7V, SB9V	VG5
2617	SB10, SB60, SB70, SB90	VG5
2135	SB10, SB60, SB70, SB90	VG5
2075	SB10, SB60, SB70, SB90	VG5
2013	SB10, SB60, SB70, SB90	VG5
2628	SB10, SB60, SB70, SB90	VG5
2628	SB1M, SB6M, SB7M, SB9M	VG5
2628	SB1R, SB6R, SB7R, SB9R	VG5
2628	SB1V, SB6V, SB7V, SB9V	VG5
2732	SB10, SB60, SB70, SB90	VG5

HUDSON

Art.-Nr.	Farb-Nr. Colour code	Verwendungsgruppe / Application group
2987	SD1B, SD2B, SD5B, SD6B, SD7B, SD8B, SD9B	VG4
2988	SD1B, SD2B, SD5B, SD6B, SD7B, SD8B, SD9B	VG4
2577	SD1B, SD2B, SD5B, SD6B, SD7B, SD8B, SD9B	VG4
2577	SD1L, SD2L, SD5L, SD6L, SD7L, SD8L, SD9L	VG3
2577	SD1M, SD2M, SD5M, SD6M, SD7M, SD8M, SD9M	VG5
2576	SD1B, SD2B, SD5B, SD6B, SD7B, SD8B, SD9B	VG4
2576	SD1L, SD2L, SD5L, SD6L, SD7L, SD8L, SD9L	VG3
2576	SD1M, SD2M, SD5M, SD6M, SD7M, SD8M, SD9M	VG5
2526	SD1R, SD2R, SD5R, SD6R, SD7R, SD8R, SD9R	VG4
2419	SD1B, SD2B, SD5B, SD6B, SD7B, SD8B, SD9B	VG4
2852	SD1B, SD2B, SD5B, SD6B, SD7B, SD8B, SD9B	VG4
2575	SD1M, SD2M, SD5M, SD6M, SD7M, SD8M, SD9M	VG5
2525	SD1R, SD2R, SD5R, SD6R, SD7R, SD8R, SD9R	VG4
2013	SD1B, SD2B, SD5B, SD6B, SD7B, SD8B, SD9B	VG4
2135	SD1B, SD2B, SD5B, SD6B, SD7B, SD8B, SD9B	VG4
2732	SD1B, SD2B, SD5B, SD6B, SD7B, SD8B, SD9B	VG4
2732	SB10, SB60, SB70, SB90	VG5

TRIBOMETER - PRÜFUNG

PIER 45

Art.-Nr.	Farb-Nr. Colour code	Verwendungsgruppe / Application group
2736	BR60, BR80, BR90	VG5
2632	BR60, BR80, BR90	VG5
2834	BR60, BR80, BR90	VG5
2016	BR60, BR80, BR90	VG5
2030	BR60, BR80, BR90	VG5

PRO ARCHITECTURA 3.0

Art.-Nr.	Farb-Nr. Colour code	Verwendungsgruppe / Application group
3245	C300, C390, C344, C349	VG4
3246	C300, C390, C344, C349	VG4
3213	C300, C390, C344, C349	VG4
3214	C300, C390, C344, C349	VG4
3215	C300, C390, C344, C349	VG2
3350	C300C,310 C311, C360, C370, C361, C371 , C372, C390, C391, C320, C335, C349, C352, C355	VG2
3107	C300C,310 C311, C360, C370, C361, C371 , C372, C390, C391, C320, C335, C349, C352, C355	VG2
2706	C211, C260, C270, C271, C290, C291, C240, C244, C411, C460, C471, C490, C491	VG4
2200	C211, C227, C260, C261, C264, C265, C266, C270, C271, C272, C290, C291, C221, C240, C244, C245, C255, C281, C411, C460, C461, C464, C465, C466, C471, C472, C490, C491	VG4
2205	C211, C290, C240, C244	VG4
2405	C211, C260, C270, C271, C290, C291	VG4
2247	C211, C290, C240, C244	VG4
2248	C211, C260, C270, C271, C290, C291, C240, C244	VG4
2213	C211, C260, C270, C271, C290, C291, C411, C460, C471, C490, C491	VG5
2119	C411, C460, C471, C490, C491	VG4
2120	C411, C460, C471, C490, C491	VG5
2215	C411, C460, C471, C490, C491	VG4
2219	C411, C460, C471, C490, C491	VG5
2121	C411, C460, C471, C490, C491	VG4
2122	C411, C460, C471, C490, C491	VG5
2253	C411, C460, C471, C490, C491	VG5
2600	C411, C460, C471, C490, C491	VG4
2118	C411, C460, C471, C490, C491	VG4
2214	C411, C460, C471, C490, C491	VG3
2218	C411, C460, C471, C490, C491	VG3
2014	C411, C460, C471, C490, C491	VG3
2231	C411, C460, C471, C490, C491	VG4
2225	C411, C491	VG4
2226	C411, C491	VG4

UNIT ONE

Art.-Nr.	Farb-Nr. Colour code	Verwendungsgruppe / Application group
3130	UT03	VG3
3177	UT01, UT02	VG4
3105	UT01, UT02	VG6
3244	UT01, UT02	VG4
3245	UT01, UT02	VG4
3709	UT01, UT02	VG3
2200	UT41, UT42	VG4
2706	UT41, UT42	VG4

UNIT THREE

Art.-Nr.	Farb-Nr. Colour code	Verwendungsgruppe / Application group
2216	GT20, GT30, GT50	VG4
2007	GT10, GT20, GT30, GT50	VG4
2118	GT20, GT30, GT50	VG4
2010	GK10, GK20, GK30, GK50	VG4
2001	GT10, GT20, GT30, GT50	VG4
2020	GT50	VG3
2121	GT20, GT30, GT50	VG4
2122	GT20, GT30, GT50	VG5
2003	GT20, GT30, GT50	VG5
2127	GT22	VG6
2011	GT20, GT30, GT50	VG4
2119	GT20, GT30, GT50	VG4
2120	GT20, GT30, GT50	VG5
2219	GT20, GT30, GT50	VG5
2200	GT20, GT30, GT50	VG4
2008	GT10, GT20, GT30, GT50	VG4

UNIT FOUR

Art.-Nr.	Farb-Nr. Colour code	Verwendungsgruppe / Application group
2361	CT10, CT60, CT61, CT62, CT70, CT80	VG5
2360	CT10, CT60, CT61, CT62, CT70, CT80	VG5
2680	CT10, CT60, CT61, CT62, CT70, CT80	VG5
2369	CT10, CT60, CT61, CT62, CT70, CT80	VG5
2363	CT10, CT60, CT61, CT62, CT70, CT80	VG5
2706	CT10, CT60, CT61, CT62, CT70, CT80	VG5
2874	CT10, CT60, CT61, CT62, CT70, CT80	VG5
2008	GT10, GT20, GT30, GT50	VG4

X-PLANE

Art.-Nr.	Farb-Nr. Colour code	Verwendungsgruppe / Application group
2357	ZM00, ZM10, ZM20, ZM60, ZM70, ZM90, ZM91	VG5
2356	ZM00, ZM10, ZM20, ZM60, ZM70, ZM90, ZM91	VG5
2358	ZM00, ZM10, ZM20, ZM60, ZM70, ZM90, ZM91	VG5
2349	ZM00, ZM10, ZM20, ZM60, ZM70, ZM90, ZM91	VG5
2392	ZM00, ZM10, ZM20, ZM60, ZM70, ZM90, ZM91	VG5
2353	ZM10, ZM20, ZM60, ZM70, ZM90, ZM91	VG4
2680	ZM00, ZM10, ZM20, ZM60, ZM70, ZM90, ZM91	VG5
2352	ZM00, ZM10, ZM20, ZM60, ZM70, ZM90, ZM91	VG5
2351	ZM00, ZM10, ZM20, ZM60, ZM70, ZM90, ZM91	VG5
2359	ZM00, ZM10, ZM20, ZM60, ZM70, ZM90, ZM91	VG5
2354	ZM00, ZM10, ZM20, ZM60, ZM70, ZM90, ZM91	VG5
2362	ZM00, ZM10, ZM20, ZM60, ZM70, ZM90, ZM91	VG5

THE PENDULUM TESTING

The pendulum test in compliance with CEN/TS 16165

This test measures dynamic coefficient of friction (CoF). The test is designed to replicate a pedestrian heel strike, the point at which most slips occur.

When a pedestrian heel strikes a wet floor a fluid film is created between them, this can cause a slip.

This test works in wet conditions because it generates a similar fluid film between the slider and the floor.

It can be used to accurately test the slip potential on clean and dry or contaminated floors. The test also works with dry contaminants.

Understanding pendulum data

Pendulum results are referred to as Pendulum Test Values (PTV).

When the test is operated properly, the PTV should be interpreted as shown in the table.

This table relates to pedestrians walking in a straight line on a level surface. For **other activities** or inclined surfaces, the table figures will change.

The slider referred to in the test data is also important. There are two sliders commonly used, one for shod pedestrians, one for barefoot. You need to make sure the right slider has been used.

Role of the different sliders

Slider 96 (also known as Four-S rubber):

The harder of the two sliders is used to represent shod pedestrians.

Use in areas where pedestrians are likely to be wearing footwear.

Slider 57 (also known as TRRL or TRL rubber):

The softer of the two sliders is used to represent barefoot pedestrians.

Use in areas such as swimming pools, bathrooms, changing areas.

PTV	Slip Potential
0 - 24	High
25 - 35	Moderate
36+	Low

PENDELPRÜFUNG

Die Pendelprüfung nach dem Testverfahren DIN EN 16165

Mit diesem Test wird der Reibungskoeffizient gemessen. In der Testanordnung wird der Auftritt einer menschlichen Ferse simuliert, also an der Stelle des Fußes, an dem die Gleitreibung am höchsten ist.

Wenn die Ferse eines Menschen auf einem nassen Bodenbelag auftritt, entsteht zwischen Ferse und Belag ein Flüssigkeitsfilm, der wiederum ein Rutschen verursachen kann.

Der Pendulum-Test wird unter nassen Bedingungen durchgeführt, um einen solchen Flüssigkeitsfilm zwischen Reibpartner und Bodenbelag zu erzeugen.

Er kann zur genauen Prüfung des Rutschpotenzials auf sauberen und trockenen oder verschmutzten Bodenbelägen eingesetzt werden. Der Test funktioniert auch mit trockenen Verunreinigungen.

Zum Verständnis der Pendulum-Testdaten

Die Pendulum-Testergebnisse werden als Pendulum-Testwerte (Pendulum Test Values, PTV) bezeichnet.

Bei ordnungsgemäßer Durchführung des Tests sollten die PTV wie in der Tabelle angezeigt interpretiert werden.

Diese Tabelle bezieht sich auf Menschen, die auf einer geraden Linie auf einer ebenen Oberfläche gehen.

Bei **anderen Aktivitäten** oder schiefen Ebenen ändern sich die Werte in der Tabelle.

Auch der in den Testdaten angegebene Reibpartner ist von Bedeutung. Üblicherweise werden zwei Reibpartner verwendet, einer für den Schuhbereich oder einer für den Barfußbereich. Sie müssen sicherstellen, dass der richtige Reibpartner verwendet worden ist.

Rolle der verschiedenen Reibpartner (sog. Slider)

Slider 96 (auch als „Four-S-Rubber“ bezeichnet):

Der **härtere** der beiden Reibpartner wird zur Simulation eines Fußes eingesetzt, der einen Schuh trägt.

Dieser Reibpartner sollte in Bereichen verwendet werden, in denen das Tragen von Schuhen wahrscheinlich ist.

Slider 57 (auch als TRRL- oder TRL-Rubber bezeichnet):

Der **weichere** der beiden Reibpartner wird zur Simulation eines barfußigen Fersenauftritts eingesetzt.

Dieser Reibpartner sollte in Schwimmbecken, Bädern und Umkleiden verwendet werden.

PTV	Rutschpotenzial
0 - 24	Hoch
25 - 35	Mittel
36+	Niedrig

THE PENDULUM TESTING

ABERDEEN

Art.-Nr.	Farb-Nr. Colour code	96-wet	96-dry	57-wet	57-dry
2987	SB10, SB60, SB70, SB90	>36	>40	>36	>40
2577	SB10, SB60, SB70, SB90	>36	>40	>36	>40
2576	SB10, SB60, SB70, SB90	>36	>40	>36	>40
2988	SB10, SB60, SB70, SB90	>36	>40	>36	>40
2685	SB1M, SB6M, SB7M, SB9M	>36	>40	>36	>40
2526	SB1R, SB6R, SB7R, SB9R	>40	>40	>40	>40
2536	SB1V, SB6V, SB7V, SB9V	>40	>40	>40	>40
2617	SB10, SB60, SB70, SB90	>36	>40	>36	>40
2628	SB10, SB60, SB70, SB90	>36	>40	>36	>40
2628	SB1M, SB6M, SB7M, SB9M	>36	>40	>36	>40
2628	SB1R, SB6R, SB7R, SB9R	>40	>40	>40	>40
2628	SB1V, SB6V, SB7V, SB9V	>40	>40	>40	>40
2732	SB10, SB60, SB70, SB90	>36	>40	>36	>40

ATLANTA

Art.-Nr.	Farb-Nr. Colour code	96-wet	96-dry	57-wet	57-dry
2730	AL10, AL40, AL60, AL70, AL80, AL90	<36	>40	<36	>40
2660	AL10, AL40, AL60, AL70, AL80, AL90	<36	>40	<36	>40
2394	AL10, AL40, AL60, AL70, AL80, AL90	<36	>40	<36	>40
2810	AL10, AL40, AL60, AL70, AL80, AL90	<36	>40	<36	>40
2733	AL10, AL40, AL60, AL70, AL80, AL90	<36	>40	<36	>40

BACK HOME

Art.-Nr.	Farb-Nr. Colour code	96-wet	96-dry	57-wet	57-dry
2085	BT10, BT20, BT60, BT90	<36	>40	<36	>40
2349	BT10, BT20, BT60, BT90	<36	>40	<36	>40
2733	BT10, BT20, BT60, BT90	<36	>40	<36	>40

BELLAGIO

Art.-Nr.	Farb-Nr. Colour code	96-wet	96-dry	57-wet	57-dry
2660	TM6M	<36	>40	<36	>40
2660	TM6L	<36	>40	<36	>40

BERNINA

Art.-Nr.	Farb-Nr. Colour code	96-wet	96-dry	57-wet	57-dry
2660	RT2M	<36	>40	<36	>40
2394	RT2M	<36	>40	<36	>40
2393	RT2M	<36	>40	<36	>40
2409	RT2M	<36	>40	<36	>40
2410	RT2M	<36	>40	<36	>40
2411	RT2M	<36	>40	<36	>40

CÁDIZ

Art.-Nr.	Farb-Nr. Colour code	96-wet	96-dry	57-wet	57-dry
2570	BU0M, BU1M, BU7M, BU9M	<36	>40	<36	>40
2572	BU0M, BU1M, BU7M, BU9M	<36	>40	<36	>40
2685	BU0M, BU1M, BU7M, BU9M	<36	>40	<36	>40
2496	BU0M, BU1M, BU7M, BU9M	<36	>40	<36	>40
2037	BU0M, BU1M, BU7M, BU9M	<36	>40	<36	>40

HUDSON

Art.-Nr.	Farb-Nr. Colour code	96-wet	96-dry	57-wet	57-dry
2987	SD1B, SD2B, SD7B, SD9B	>36	>40	>36	>40
2988	SD1B, SD2B, SD7B, SD9B	>36	>40	>36	>40
2577	SD1B, SD2B, SD7B, SD9B	>36	>40	>36	>40
2577	SD1L, SD2L, SD7L, SD9L	<36	>40	<36	>40
2577	SD1M, SD2M, SD7M, SD9M	>36	>40	>36	>40
2576	SD1B, SD2B, SD7B, SD9B	>36	>40	>36	>40
2576	SD1L, SD2L, SD7L, SD9L	<36	>40	<36	>40
2576	SD1M, SD2M, SD7M, SD9M	>36	>40	>36	>40
2526	SR1R, SD2R, SD7R, SD9R	>40	>40	>40	>40
2419	SD1B, SD2B, SD7B, SD9B	>36	>40	>36	>40
2852	SD1B, SD2B, SD7B, SD9B	>36	>40	>36	>40
2575	SD1M, SD2M, SD7M, SD9M	>36	>40	>36	>40
2525	SR1R, SD2R, SD7R, SD9R	>40	>40	>40	>40
2013	SD1B, SD2B, SD7B, SD9B	>36	>40	>36	>40

LUCCA

Art.-Nr.	Farb-Nr. Colour code	96-wet	96-dry	57-wet	57-dry
2761	LS06, LS60, LS70, LS90	<36	>40	<36	>40
2660	LS06, LS60, LS70, LS90	<36	>40	<36	>40
2733	LS06, LS60, LS70, LS90	<36	>40	<36	>40
2871	LS06, LS60, LS70, LS90	<36	>40	<36	>40
2870	LS06, LS60, LS70, LS90	<36	>40	<36	>40

MARMOCHIC

Art.-Nr.	Farb-Nr. Colour code	96-wet	96-dry	57-wet	57-dry
2660	MR0M, MR6M, MR9M	<36	>40	<36	>40
2660	MRO P, MR6 P, MR9 P	<36	>40	<36	>40
2730	MR0M, MR6M, MR9M	<36	>40	<36	>40
2730	MRO P, MR6 P, MR9 P	<36	>40	<36	>40

MERIDA

Art.-Nr.	Farb-Nr. Colour code	96-wet	96-dry	57-wet	57-dry
2776	AJ10, AJ20, AJ60, AJ90	<36	>40	<36	>40
2679	AJ10, AJ20, AJ60, AJ90	<36	>40	<36	>40

METALYN

Art.-Nr.	Farb-Nr. Colour code	96-wet	96-dry	57-wet	57-dry
2730	BM06, BM10, BM40, BM60, BM61, BM70	<36	>40	<36	>40
2810	BM06, BM10, BM40, BM60, BM61, BM70	<36	>40	<36	>40
2660	BM06, BM10, BM40, BM60, BM61, BM70	<36	>40	<36	>40
2733	BM06, BM10, BM40, BM60, BM61, BM70	<36	>40	<36	>40
2394	BM06, BM10, BM40, BM60, BM61, BM70	<36	>40	<36	>40

MY EARTH

Art.-Nr.	Colour	96-wet	96-dry	57-wet	57-dry
2640	RU10, RU20, RU60, RU90	>36	>40	>36	>40
2643	RU10, RU20, RU60, RU90	>36	>40	>36	>40
2641	RU10, RU20, RU60, RU90	>36	>40	>36	>40
2644	RU10, RU20, RU60, RU90	>36	>40	>36	>40
2642	RU10, RU20, RU60, RU90	>36	>40	>36	>40
2645	RU10, RU20, RU60, RU90	>36	>40	>36	>40
2647	RU10, RU20, RU60, RU90	>36	>40	>36	>40
2646	RU10, RU20, RU60, RU90	>36	>40	>36	>40
2649	RU10, RU20, RU60, RU90	>36	>40	>36	>40

NATURAL BLEND

Art.-Nr.	Farb-Nr. Colour code	96-wet	96-dry	57-wet	57-dry
2394	LY20, LY60	<36	>40	<36	>40
2660	LY20, LY60	<36	>40	<36	>40
2356	LY20, LY60	<36	>40	<36	>40
2730	LY20, LY60	<36	>40	<36	>40
2680	LY20, LY60	>40	>40	<36	>40

NORTHFIELD

Art.-Nr.	Farb-Nr. Colour code	96-wet	96-dry	57-wet	57-dry
2337	RD60, RD70, RD90	<36	>40	<36	>40
2336	RD60, RD70, RD90	<36	>40	<36	>40
2030	RD60, RD70, RD90	<36	>40	<36	>40

OAK PARK

Art.-Nr.	Farb-Nr. Colour code	96-wet	96-dry	57-wet	57-dry
2793	HR00, HR10, HR20, HR30, HR80, HR90	<36	>40	<36	>40
2792	HR00, HR10, HR20, HR30, HR80, HR90	<36	>40	<36	>40

OAK SIDE

Art.-Nr.	Farb-Nr. Colour code	96-wet	96-dry	57-wet	57-dry
2793	HE10, HE20, HE30, HE80	<36	>40	<36	>40
2792	HE10, HE20, HE30, HE80	<36	>40	<36	>40

PENDELPRÜFUNG

PRO ARCHITECTURA 3.0

Art.-Nr.	Farb-Nr. Colour code	96-wet	96-dry	57-wet	57-dry
2014	C411, C460, C471, C490, C491	<25	>36	<25	>36
2118	C411, C460, C471, C490, C491	>36	>36	<36	>36
2119	C411, C460, C471, C490, C491	>36	>36	>36	>36
2120	C411, C460, C471, C490, C491	>36	>36	>36	>36
2121	C411, C460, C471, C490, C491	>36	>36	<36	>36
2122	C411, C460, C471, C490, C491	>36	>36	>36	>36
2200	C211, C260, C261, C264, C265, C266, C270, C271, C272, C290, C291, C221, C227, C240, C244, C245, C255, C281, C411, C460, C461, C464, C465, C466, C471, C472, C490, C491	<36	>36	<36	>36
2205	C211, C290, C240, C244,	>36	>36	>36	<36
2213	C411, C460, C471, C490, C491, C211, C260, C270, C271, C290, C291	<25	>36	<25	>36
2214	C411, C460, C471, C490, C491	<25	>36	<25	>36
2215	C411, C460, C471, C490, C491	<36	>36	<36	>36
2218	C411, C460, C471, C490, C491	<25	>36	<25	>36
2219	C411, C460, C471, C490, C491	>36	>36	>36	>36
2225	C411, C491				
2226	C441, C491				
2231	C411, C460, C471, C490, C491	<25	>36	<25	>36
2247	C211, C290, C240, C244,	>36	>36	>36	<36
2248	C211, C260, C270, C271, C290, C291, C240, C244	<36	>36	<36	>36
2253	C411, C460, C471, C490, C491	>36	>36	>36	>36
2405	C211, C260, C270, C271, C290, C291	<36	>36	<36	>36
2600	C411, C460, C471, C490, C491	<36	>36	<36	>36
2702	C211, C290, C240, C244,	<36	>36	<36	>36
2706	C211, C260, C270, C271, C290, C291, C240, C244, C290, C411, C460, C471, C490, C491	<36	>36	<36	>36
3213	C300, C390, C344, C349	<36	>36	<36	>36
3214	C300, C390, C344, C349	<36	>36	<36	>36
3245	C300, C390, C344, C349	<36	>36	<36	>36
3246	C300, C390, C344, C349	<36	>36	<36	>36
3709	C300, C310, C311, C360, C361, C371, C372, C390, C391, C320, C335, C349, C352, C355	<25	>36	<25	>36
3753	C300, C310, C311, C360, C361, C371, C372, C390, C391	<25	>36	<25	>36

PURE BASE

Art.-Nr.	Farb-Nr. Colour code	96-wet	96-dry	57-wet	57-dry
2360	BZ06, BZ10, BZ40, BZ60, BZ70	>40	>40	>40	>40
2361	BZ06, BZ10, BZ40, BZ60, BZ70	>40	>40	>40	>40
2835	BZ06, BZ10, BZ40, BZ60, BZ70	>40	>40	>40	>40

PURE LINE 2.0

Art.-Nr.	Farb-Nr. Colour code	96-wet	96-dry	57-wet	57-dry
2750	UL10, UL60, UL61, UL62, UL70, UL72, UL80, UL90	<36	>40	<36	>40
2751	UL10, UL60, UL61, UL62, UL70, UL72, UL80, UL90	<36	>40	<36	>40
2752	UL10, UL60, UL61, UL62, UL70, UL72, UL80, UL90	<36	>40	<36	>40
2753	UL10, UL60, UL61, UL62, UL70, UL72, UL80, UL90	<36	>40	<36	>40
2754	UL10, UL60, UL61, UL62, UL70, UL72, UL80, UL90	<36	>40	<36	>40
2620	UL10, UL60, UL61, UL62, UL70, UL72, UL80, UL90	<36	>40	<36	>40
2617	UL10, UL60, UL61, UL62, UL70, UL72, UL80, UL90	<36	>40	<36	>40

SPOTLIGHT

Art.-Nr.	Farb-Nr. Colour code	96-wet	96-dry	57-wet	57-dry
2810	CM0M, CM6M, CM7M, CM9M	<36	>40	<36	>40
2810	CM0L, CM6L, CM7L, CM9L	>36	>40	>36	>40
2660	CM0M, CM6M, CM7M, CM9M	<36	>40	<36	>40
2660	CM0L, CM6L, CM7L, CM9L	>36	>40	>36	>40
2733	CM0M, CM6M, CM7M, CM9M	<36	>40	<36	>40
2394	CM0M, CM6M, CM7M, CM9M	<36	>40	<36	>40
2919	CM05, CM65, CM75, CM95	<36	>40	<36	>40
2030	CM0M, CM6M, CM7M, CM9M	<36	>40	<36	>40

UNIT FOUR

Art.-Nr.	Farb-Nr. Colour code	96-wet	96-dry	57-wet	57-dry
2361	CT10, CT60, CT61, CT62, CT70, CT80	>36	>40	>36	>40
2360	CT10, CT60, CT61, CT62, CT70, CT80	>36	>40	>36	>40
2680	CT10, CT60, CT61, CT62, CT70, CT80	>36	>40	>36	>40
2369	CT10, CT60, CT61, CT62, CT70, CT80	>36	>40	>36	>40
2363	CT10, CT60, CT61, CT62, CT70, CT80	>36	>40	>36	>40
2706	CT10, CT60, CT61, CT62, CT70, CT80	>36	>40	>36	>40

URBAN JUNGLE

Art.-Nr.	Farb-Nr. Colour code	96-wet	96-dry	57-wet	57-dry
2810	TC10, TC60, TC70, TC90	<36	>40	<36	>40
2660	TC10, TC60, TC70, TC90	<36	>40	<36	>40
2394	TC10, TC60, TC70, TC90	<36	>40	<36	>40
2733	TC10, TC60, TC70, TC90	<36	>40	<36	>40

WORKSHOP

Art.-Nr.	Farb-Nr. Colour code	96-wet	96-dry	57-wet	57-dry
2871	BC30	>36	>40	>36	>40
2870	BC30	>36	>40	>36	>40

X-PLANE

Art.-Nr.	Farb-Nr. Colour code	96-wet	96-dry	57-wet	57-dry
2357	ZM00, ZM10, ZM20, ZM60, ZM70, ZM90, ZM91	<36	>40	<36	>40
2356	ZM00, ZM10, ZM20, ZM60, ZM70, ZM90, ZM91	<36	>40	<36	>40
2349	ZM00, ZM10, ZM20, ZM60, ZM70, ZM90, ZM91	<36	>40	<36	>40
2392	ZM00, ZM10, ZM20, ZM60, ZM70, ZM90, ZM91	<36	>40	<36	>40
2353	ZM10, ZM20, ZM60, ZM70, ZM90, ZM91	<36	>40	<36	>40
2680	ZM00, ZM10, ZM20, ZM60, ZM70, ZM90, ZM91	<36	>40	<36	>40
2352	ZM00, ZM10, ZM20, ZM60, ZM70, ZM90, ZM91	<36	>40	<36	>40
2351	ZM00, ZM10, ZM20, ZM60, ZM70, ZM90, ZM91	<36	>40	<36	>40
2359	ZM00, ZM10, ZM20, ZM60, ZM70, ZM90, ZM91	<36	>40	<36	>40
2354	ZM00, ZM10, ZM20, ZM60, ZM70, ZM90, ZM91	<36	>40	<36	>40
2362	ZM00, ZM10, ZM20, ZM60, ZM70, ZM90, ZM91	<36	>40	<36	>40

WEAR RESISTANCE

Wear-resistance properties of glazed vitreous and porcelain stoneware tiles in accordance with EN ISO 10545-7

All floor coverings are exposed to wear.

The extent of wear is primarily dependent on the following factors:

- Frequency of use
- Degree of soiling and cleaning conditions
- Type of mechanical stress caused by walking and driving etc.
- The hardness of the glaze
- The thickness of the glaze layer
- The glaze finish (matt, semi-matt, gloss)
- The colour and brightness of the glaze

As a rule, floor covering material is worn down by sand and dirt particles that adhere to the soles of shoes and act like sandpaper under high pressure.

Glazed vitreous and porcelain stoneware tiles are characterised by a particularly easy-care finish. Glazed vitreous and porcelain stoneware tiles which are selected according to the area of application concerned and cleaned on a regular basis are highly durable.

If abrasive materials, such as dirt contained in quartz sand, are allowed to act on the glaze for long periods of time, a loss of gloss and gradual increase in roughness of the surface may result. However, as the serviceability of the floor covering remains unimpaired, this does not constitute a justifiable ground for complaints.

Scratches in the glaze are caused by materials of at least equal hardness, such as quartz grains, sand, dirt or similar in conjunction with a load and movements over the covering. They can, for example, be caused when carrying out work or moving pieces of furniture. The best protection is afforded by providing large door mats or other suitable dirt-catchers at all entrances.

ABRIEB/VERSCHLEISS

Verschleißigenschaften glasierter Steinzeug- und Feinsteinzeugfliesen nach EN ISO 10545-7

Alle Bodenbeläge sind dem Verschleiß ausgesetzt. Dieser hängt im Wesentlichen von folgenden Faktoren ab:

- von der Benutzungsfrequenz
- von den Verschmutzungs- bzw. Reinigungsbedingungen
- von der Art der mech. Beanspruchung durch Begehen, Befahren etc.
- von der Härte der Glasur
- von der Dicke der Glasurschicht
- vom Glanzgrad der Glasur (matt, halbmatt, glänzend)
- von der Farbe und dem Helligkeitsgrad der Glasur

Im Normalfall wird der Verschleiß von Bodenbelägen durch Sand- und andere Schmutzpartikel verursacht, die bei Geh- und Drehbewegungen wie Schmirgel unter hohem Druck wirken.

Glasierte Steinzeug- und Feinsteinzeugfliesen zeichnen sich durch ihre besonders pflegeleichte Oberfläche aus. Regelmäßig gereinigte und für den jeweiligen Anwendungsbereich zweckmäßig ausgewählte glasierte Steinzeug und Feinsteinzeugfliesen haben eine lange Lebensdauer.

Kratzende Stoffe, etwa Schmutzbeimengungen von Quarzsand, führen im Laufe der Zeit allerdings zu einer Glanzminderung oder zu einer gewissen Rauigkeit der Oberfläche. Solche nutzungsbedingten Veränderungen können aber, da sie die Gebrauchseigenschaft der Fliese nicht beeinträchtigen, nicht Gegenstand für Beanstandungen sein.

Kratzer in der Glasur werden erzeugt durch Anritzen mit härteren oder zumindest gleichharten Stoffen wie z. B. Quarzkörner, Sand, Schmutz o. Ä. in Verbindung mit einer Auflast und Bewegungsabläufen über den Belag. Sie können auch bei Verschiebung von Lasten (auch von Möbelstücken) entstehen. Um dem vorzeitigen Oberflächenverschleiß vorzubeugen, werden in Eingangsbereichen großflächige Reinigungszonen empfohlen.

WEAR RESISTANCE

Wear-resistance groups

Wear-resistance group **0** lightest stress

Unsuitable for the floor area. Villeroy & Boch does not manufacture products in wear-resistance group **0**!

Wear-resistance group **1** very light stress

For floors in areas subject to very infrequent use, (soft-soled shoes) and no abrasive contamination.

Examples: Bedrooms and bathrooms in private homes.

Wear-resistance group **2** light stress

For floors in areas subject to infrequent use, (normal street shoes) and small amounts of abrasive contamination.

Examples: Private homes, with the exception of kitchens, stairs, terraces, loggias.

Wear-resistance group **3** medium stress

For floors in areas subject to frequent use, (normal street shoes) and abrasive contamination.

Examples: whole living area, including bathrooms, hallways, corridors, balconies, loggias, apart from kitchens; hotel rooms and bathrooms; sanitary and therapy rooms in hospitals.

Wear-resistance group **4** medium-heavy stress

For floors in areas subject to frequent use (normal street shoes) and frequent, intense soiling.

Examples: private entrances and kitchens, terraces, sales rooms and utility rooms, offices, hotels etc.; floors in schools, administration buildings, hospitals etc.

Wear-resistance group **5** heavy stress

The tiles of the wear-resistance group **5**, which provide a very high wear resistance, are available for areas subjected to intense public use.

Examples: bakeries, snack bars, entrance halls of hotels and banks, restaurants.

Maximum stress

For heavily frequented application areas or those subjected to extreme surface wear, for example, in the areas surrounding cash tills or entrance areas to passage ways, we recommend the use of unglazed porcelain stoneware, which has an unusually high degree of wear resistance.

At points that are subject to extreme wear – and this applies to all areas of application – deviations from the overall appearance of the surface are possible. In borderline cases, it is therefore recommendable to choose the next-higher wear-resistance group.

Tiles belonging to higher wear-resistance groups can, of course, be used in areas subject to lower requirements.

Wear-resistance properties of unglazed porcelain stoneware tiles

Unglazed porcelain stoneware tiles, as described in standard DIN EN 14411, Group BIa water absorption $E_b \leq 0.5\%$, are considered to have some of the highest wear-resistance properties (deep abrasion) of all floor covering materials. This homogeneous material reveals virtually no signs of wear, even after decades of intensive use.

Deep abrasion is the name for the wear of unglazed porcelain stoneware tiles as a result of grinding and abrasive stress.

The permissible tolerances are specified as minimum requirements in the relevant standard (DIN EN ISO 10545-6 – resistance to the deep abrasion of unglazed tiles and slabs, volume loss – max 175 mm³).

At points that are subject to extreme wear – and this applies to all areas of application – deviations from the overall appearance of the surface are possible.

ABRIEB/VERSCHLEISS

Abriebgruppen

Abriebgruppe **0** Leichteste Beanspruchung

Für den Bodenbereich ungeeignet. Villeroy&Boch stellt keine Produkte der Abriebgruppe **0** her!

Abriebgruppe **1** Sehr leichte Beanspruchung

Bodenbeläge in Räumen, die bei niedriger Begehungsfrequenz ohne kratzende Verschmutzung mit weich besohltm Schuhwerk begangen werden.

Beispiele: Schlaf- und Sanitärräume im privaten Wohnbereich.

Abriebgruppe **2** Leichte Beanspruchung

Bodenbeläge in Räumen, die bei niedriger Begehungsfrequenz unter geringer kratzender Verschmutzung mit normalem Schuhwerk belastet werden.

Beispiele: Privater Wohnbereich, außer Küchen, Treppen, Terrassen, Loggien.

Abriebgruppe **3** Mittlere Beanspruchung

Bodenbeläge in Räumen, die bei mittlerer Begehungsfrequenz unter kratzender Verschmutzung mit normalem Schuhwerk belastet werden.

Beispiele: Gesamter Wohnbereich mit Bädern, Dielen, Flure, Balkonen, Loggien, (ausgenommen Küchen); Hotelzimmer und -bäder; Sanitär- und Therapieräume in Krankenhäusern.

Abriebgruppe **4** Stärkere Beanspruchung

Bodenbeläge in Räumen, die bei stärkerer Begehungsfrequenz mit normalem Schuhwerk in Bezug auf die Verschmutzungs- und Belastungshäufigkeit intensiver beansprucht werden.

Beispiele: Eingänge und Küchen im Wohnungsbau, Terrassen, Verkaufs- und Wirtschaftsräume, Büros, Hotels, u.ä.; Böden in Schulen, Verwaltungsgebäuden, Krankenhäusern usw.

Abriebgruppe **5** Starke Beanspruchung

Für Anwendungsbereiche mit sehr starkem Publikumsverkehr stehen die Fliesen der Abriebgruppe **5** zur Verfügung, die einen sehr hohen Verschleißwiderstand aufweisen.

Beispiele: Bäckereien, Imbissstuben, Eingangshallen für Hotels und Banken, Restaurants.

Stärkste Beanspruchung

Für extrem beanspruchte Anwendungsbereiche mit hoher Benutzerfrequenz und zu erwartendem hohem Oberflächenabrieb / -verschleiß – z.B. vor Ladenkassen und in Eingangsbereichen von Passagen, empfehlen wir die Verwendung von unglasiertem Feinsteinzeug. Dieses zeichnet sich durch eine außergewöhnlich hohe Abriebfestigkeit aus. An extrem beanspruchten Stellen - und das gilt für alle Anwendungsbereiche - sind vom Gesamtbild abweichende Oberflächenveränderungen nicht auszuschließen. In Grenzfällen empfiehlt es sich daher, die Fliese nächst höherer Beanspruchungsgruppe zu wählen.

Verschleißigenschaften unglasierter Feinsteinzeugfliesen

Unglasierte Feinsteinzeugfliesen nach DIN EN 14411, Gruppe B1a Wasseraufnahme $E_b \leq 0,5\%$, haben einen Verschleißwiderstand (Tiefenverschleiß), der zu den höchsten aller Bodenbeläge gehört.

Dieses homogene Material weist praktisch auch nach Jahrzehnte langer intensiver Nutzung keinerlei Gebrauchsspuren auf.

Als Tiefenverschleiß bezeichnet man den Scherbenabrieb bei unglasierten Feinsteinzeugfliesen infolge von schleifender, reibender Beanspruchung. Die zulässigen Toleranzen sind als Mindestanforderungen in der betreffenden Prüfnorm (DIN EN ISO 10545-6 – Widerstand gegen Tiefenverschleiß von unglasierten Fliesen und Platten, Volumenverlust – max. 175 mm³) festgelegt. An extrem beanspruchten Stellen - und das gilt für alle Anwendungsbereiche - sind vom Gesamtbild abweichende Oberflächenveränderungen nicht auszuschließen.

UPEC – CLASSIFICATION



QB-UPEC is a French floor-tile classification for manufacturers pursuant to the QB 32 certification standard ‘General requirements for the QB classification’ and the ‘Technical and administrative appendix’. This optional certification is issued by the CSTB (Centre Scientifique et Technique du Bâtiment). Assuming that the products are in compliance with the requirements set out under the current CSTB specification sheet no. 3778, ‘Specification sheet concerning the UPEC classification and classification of the interiors’, they shall be certified and be assigned a UPEC classification. The UPEC classification and the classification of the interiors are presented in CSTB specification sheet no. 3782.

The primary objective of UPEC classification is to identify a floor covering the performance of which is tailored to the loads occurring within the room. It is generally assumed that

in the event of normal use and proper maintenance, the service life should be no less than ten years.

Only certified manufacturers are entitled to refer to the UPEC classification of their tested tiles. Consequently, Villeroy & Boch is entitled to use the QB-UPEC logo and to state the UPEC classification on tile packages of certified tile works.

This certification guarantees

- that the tiles comply with the EN 14411 standard, Appendices G and H,
- that the tiles actually possess the wear resistance properties defined by the UPEC classification (regular checking by an independent laboratory)
- and that the tiles originate from a production facility that is subject to extremely strict rules and monitoring at all times.

The meaning of the individual letters of the acronym

The following information is purely indicative in nature and does not replace the official result of the CSTB.

The letter “U” reflects the impact of footfall and its effects in: U2 and U2S for rooms intended for private use; U3 for rooms intended for moderate public use; U3S is assigned to rooms intended for public use in which footfall is greater than in U3; U4 is assigned to rooms intended for public use with heavy footfall.

‘P’ is assigned to the mechanical impacts of fixed or mobile furniture and maintenance equipment, along with falling objects (shocks) pursuant to the following key figures: P2 and P3 are assigned to interiors that are primarily utilised for people and for pedestrian traffic; P4 and P4S are assigned to interiors subject to heavy impacts.

‘E’ describes the behaviour of the floor covering when exposed to water and moisture. The highest value, Index 3, is always assigned to ceramic tiles.

The letter ‘C’ accounts for the consequences of chemical or physicochemical impacts of substances that have a negative effect on the durability of the floor covering (staining, attacks the impact of which extends to some depth, etc.).

These tiles are assigned the Index values 0, 1, 2 and - in exceptional cases - 3.

Index 3 is assigned to floor coverings only following specialised tests based on the specific use to which the rooms are to be put (examples: laboratories for medical analyses, hairdressing salons, etc.).

The tiles from Villeroy & Boch are classified C2, meaning that they offer excellent resistance to chemical products and are also quite resistant to staining.



Further information can be found on the official CSTB website
<https://evaluation.cstb.fr/fr/rechercher/produits-evalues/?mots=villeroy+boch&familles=carrelage&tri=date>

WallPEC – CLASSIFICATION



CSTB introduced a new quality label for wall tiles in February 2021. The QB WallPEC Certification indicates compliance with the dimensional properties, mechanical resistance of the

tiles (letter P), their behaviour in response to water (Levels E1 and E3) and in response to chemical agents/staining (Levels C1 and C2).

UPEC – KLASSIFIZIERUNG



QB-UPEC ist eine französische Kennzeichnung für Bodenfliesen, die den Herstellern nach der QB 32 Zertifizierungsnorm „Allgemeine Anforderungen an die Klassifizierung QB“ und „Technischer und administrativer Anhang“ zugeordnet ist. Diese optionale Zertifizierung wird vom CSTB (Centre Scientifique et Technique du Bâtiment) ausgestellt.

Wenn also davon ausgegangen wird, dass die Produkte den Anforderungen des aktuellen CSTB-Merkblattes 3778 „Merkblatt über die UPEC-Klassifizierung und Klassifizierung der Räumlichkeiten“ entsprechen, werden sie zertifiziert und erhalten eine UPEC-Klassifizierung. Diese ist ebenso wie die Klassifizierung der Räumlichkeiten in dem CSTB-Merkblatt Nr. 3782 dargestellt.

Die Bedeutung der einzelnen Zeichen

Die folgenden Informationen sind rein indikativ und ersetzen nicht das offizielle Ergebnis des CSTB.

„U“ betrifft die trittbedingte Abnutzung und deren Auswirkungen in: U2 und U2S privat genutzten Räumen; U3 öffentlichen moderat genutzten Räumen; U3S öffentlich genutzten Räumen mit einer höheren Verkehrsintensität als U3; U4 öffentlich genutzten Räumen mit hoher Verkehrsdichte.

„P“ spiegelt die mechanischen Einwirkungen von Möbeln und mobilen Handhabungs- und Wartungsgeräten sowie fallenden Gegenständen (Schocks) gemäß den folgenden Kennzahlen wider: P2 und P3 sind Räumlichkeiten für den Aufenthalt von Personen und den Fußgängerverkehr; P4 und P4S sind Räumlichkeiten, die schweren Einwirkungen ausgesetzt sind.

Die UPEC-Klassifizierung zielt darauf ab, die Leistung eines Belags an die im Raum auftretenden Belastungen anzupassen. Dabei geht man davon aus, dass bei normalem Gebrauch und ordnungsgemäßer Wartung die Haltbarkeit eines Belags nicht weniger als 10 Jahre beträgt.

Die Zertifizierung garantiert,

- dass die Fliesen der Norm EN 14411 Anhänge G und H entsprechen
- dass sie tatsächlich die Abriebfestigkeits-eigenschaften aufweisen, die durch die UPEC Klassifizierung definiert sind (regelmäßige Kontrollen durch ein unabhängiges Labor)
- und dass sie aus einer ständig kontrollierten Produktion nach sehr strengen Vorschriften

„E“ beschreibt das Verhalten des Belags gegenüber Wasser und Feuchtigkeit. Bei keramischen Fliesen ist hier immer der höchste Index 3 zugeordnet.

Der Buchstabe „C“ berücksichtigt die Folgen der chemischen oder physikochemischen Einwirkung von Substanzen, die sich auf die Haltbarkeit des Belags negativ auswirken (Flecken, mehr oder weniger tiefwirkende Angriffe usw.).

Die Fliesen sind den Kennzahlen 0, 1, 2 und in Ausnahmefällen 3 zugeordnet.

Die Kennzahl 3 wird einem Bodenbelag erst nach besonderen, von der jeweiligen Bestimmung dieser Räumlichkeiten abhängigen Prüfungen zuerkannt (Beispiele: Laboratorien für medizinische Analysen, Friseursalons).

Alle Fliesen von Villeroy & Boch sind C2 klassifiziert und bieten somit eine sehr hohe Beständigkeit gegen chemische Produkte und sind ebenfalls wenig anfällig gegen Flecken.



Weitere Informationen finden Sie auf der offiziellen Seite von CSTB

<https://evaluation.cstb.fr/fr/rechercher/produits-evalues/?mots=villeroy+boch&familles=carrelage&tri=date>

WallPEC – KLASSIFIZIERUNG



Seit Februar 2021 hat CSTB ein neues Qualitätskennzeichen für Wandfliesen eingeführt. Die QB WallPEC-Zertifizierung bezieht sich auf die Einhaltung der dimensional

en, der mechanischen Beständigkeit der Fliesen (Buchstabe P), ihres Verhaltens gegenüber Wasser (Stufen E1 und E3) und bei chemischen Mitteln/Fleckenbildung (Stufen C1 und C2).

SHADE VARIATION

Ceramic tiles by Villeroy & Boch are natural-looking products with a wide variety of colours and textures. Thanks to innovative manufacturing methods, today ceramic tiles offer a range of variations that are otherwise known only among natural materials, such as stone, earth and wood.

This variety is a particular design hallmark of the individual tiles and ranges. As with natural products the colour and structure can vary considerably. This natural variation in design is appreciated as such and should be taken into account when selecting a tile range.

To achieve the best possible effect of the surface in a room, the tiles should be laid out in advance.

We have four groups with different variation intensity, which influences the overall effect of the layout.

1 - low

Almost identical appearance of the tiles with minor to barely perceptible deviations in colour and structure for a uniform effect.

2 - medium

Minor variations in colour and structure for a restful, natural effect.

3 - high

Greater variations in colour and structure for a lively natural effect.

4 - strong

Strong variations in colour and structure for a colourful and/or structurally intense and varied effect.

COLOUR CODES IN ACCORDANCE WITH RAL AND NCS

To enable detailed planning by architects and designers, we have allocated standardised codes to the colours of selected ranges.

Codes for the RAL CLASSIC (4-digit) and RAL DESIGN (7-digit) colour lines are used in addition to codes for the NCS system. The allocations are to be found in the table next to the respective Villeroy & Boch colour codes.

In the case of monochrome tiles, the colour designations indicate the comparable or closely related colour code. The information for structured, coloured tiles relate to the overall impression of the tile covering. As a general principle, it is to be noted that the stated RAL or NCS colours for these ranges represent an average assessment.

LUMINOUS REFLECTANCE VALUE (LRV)

The luminous reflectance value indicates the percentage proportion of visible light reflected by a surface (depending on the nuances, the LRV value may vary slightly). The luminance contrast is determined by reference to the luminous reflectance values of different parts of a building (e.g. at landings,

at transitions between different surfaces, etc.). The luminance contrast is the difference between the brightness of an object and its background or surrounding. In accessible and inclusive construction, the contrasts are mandatory for stairs, doors, furnishings, obstacles, etc.

VARIATIONSVIELFALT

Bei keramischen Fliesen von Villeroy & Boch handelt es sich um natürlich anmutende Produkte mit variantenreicher Farbgebung und Strukturbildung. Dank innovativer Fertigungsverfahren bieten keramische Fliesen heute eine Variationsvielfalt, wie man sie ansonsten nur von Naturmaterialien wie Stein, Erde und Holz kennt.

Diese Variationsvielfalt ist ein besonderes Designmerkmal der einzelnen Fliesen und Serien. Wie bei Naturprodukten fallen die Abweichungen von Farben und Strukturen unterschiedlich stark aus. Diese natürliche Variationsvielfalt im Design wird als solche besonders geschätzt und sollte bei der Auswahl der Fliesenserie berücksichtigt werden.

Um die bestmögliche Wirkung der Fläche im Raum zu erzielen, sollten die Fliesen vorab ausgelegt werden.

Wir unterscheiden vier Gruppen mit ansteigender Intensität der Variationsvielfalt, die das Gesamtbild eines Raumbelags beeinflusst.

1 - gering

Von Fliese zu Fliese nahezu gleichbleibendes Aussehen mit gering bis kaum wahrnehmbaren Abweichungen der Farben und Strukturen für ein uniformes Gesamtbild des Belags.

2 - mittel

Von Fliese zu Fliese leicht abweichende Farben und Strukturen, die im Belag jedoch ein ruhiges, natürliches Gesamtbild ergeben.

3 - hoch

Von Fliese zu Fliese höher abweichende Farben und Strukturen, die ein lebhaft natürliches Gesamtbild des Belages erzielen.

4 - stark

Von Fliese zu Fliese stark abweichende Farben und Strukturen, die ein farblich und/oder strukturell intensives, abwechslungsreiches Gesamtbild des Belages hervorrufen.

FARBCODIERUNGEN NACH RAL UND NCS

Für detailgetreue Planungen von Architekten und Gestaltern haben wir die Farben ausgewählter Serien in standardisierten Codierungen erfasst.

Zum Einsatz kommen Codierungen der Farbreihen RAL CLASSIC (4-stellig) und RAL DESIGN (7-stellig) sowie des NCS Systems. Sie finden die Zuordnungen in der Tabelle neben den jeweiligen Villeroy & Boch Farbcodierungen.

Bei unifarbenen Fliesen geben die Farbbezeichnungen den vergleichbaren bzw. nahe liegenden Farbcode an. Die Angaben bei farblich strukturierten Fliesen beziehen sich auf den Gesamteindruck des Fliesenbelages. Bei diesen Serien ist grundsätzlich zu beachten, dass es sich bei der genannten RAL- bzw. NCS-Farben um einen Durchschnittswert handelt.

LICHTREFLEXIONSWERT (LRV)

Der Lichtreflexionswert gibt den prozentualen Anteil des von einer Oberfläche reflektierten sichtbaren Licht an (in Abhängigkeit der Nuancen kann der LRV-Wert leicht variieren). Mit Hilfe der LRV-Werte von unterschiedlichen Bauteilen (z.B. bei Treppenabsätzen, bei Übergängen zwischen verschiedenen Oberflächen, u.ä.) wird der Leuchtdichtekontrast ermittelt.

Unter Leuchtdichtekontrast versteht man die Differenz zwischen der Helligkeit eines Objektes zu seinem Hintergrund oder seiner Umgebung. Beim barrierefreien und inklusiven Bauen sind die Kontraste für Treppen, Türen, Einrichtungsgegenstände, Hindernisse, usw. obligatorisch.

COLOUR CODES

ABERDEEN

Farb-Nr. Colour code		NCS	RAL	LRV
SB00		NCS S 0500-N	9003	
SB10, 1M, 1V		NCS S 2002-Y50R	000 75 00	42,0
SB60, 6M, 6V		NCS S 4000-N	000 65 00	33,4
SB70, 7M, 7V		NCS S 4005-Y80R	060 60 05	28,0
SB90, 9M, 9V		NCS S 6000-N	000 50 00	16,3

ATLANTA

Farb-Nr. Colour code		NCS	RAL	LRV
AL00		NCS S 0500-N	000 90 00	
AL10 (SG)		NCS S 0502-R	100 90 05	
AL10 (FSZ)		NCS S 2005-Y90R	000 80 00	47,0
AL40		NCS S 1500-N	000 75 00	43,1
AL60		NCS S 3500-N	000 65 00	28,6
AL70		NCS S 2005-Y80R	060 70 05	33,1
AL80		NCS S 6005-Y50R	080 50 05	15,9
AL90		NCS S 4500-N	000 55 00	14,9

BACK HOME

Farb-Nr. Colour code		NCS	RAL	LRV
BT01, BT02		NCS S 1000-N	000 90 00	75,0
BT21, BT22		NCS S 1002-Y50R	090 90 05	70,3
BT10		NCS S 1500-N	000 80 00	50,3
BT20		NCS S 2005-Y50R	060 70 10	40,9
BT60		NCS S 5000-N	000 55 00	20,5
BT90		NCS S 7000-N	000 40 00	12,2

BERNINA

Farb-Nr. Colour code		NCS	RAL	LRV
RT2M		S 7005-R80B	7015	8,5

BOURGOGNA

Farb-Nr. Colour code		NCS	RAL	LRV
DM20		NCS S 3005-Y50R	060 70 05	40,8
DM60		NCS S 2502-R	100 70 05	40,4
DM70		NCS S 4005-Y50R	060 60 05	36,8
DM90		NCS S 5502-R	000 45 00	18,7

CÁDIZ

Farb-Nr. Colour code		NCS	RAL	LRV
BU00		S 1002-Y50R	075 92 05	69,7
BU0M		S 1002-R	080 80 05	59,3
BU1M		S 2002-Y50R	060 70 05	33,8
BU2M		S 2005-Y50R	060 80 10	45,1
BU7M		S 5502-Y	100 50 05	19,2
BU9M		S 5502-R	080 50 05	13,3

CODE 2

Farb-Nr. Colour code		NCS	RAL	LRV
SN60		NCS S 5502-Y	120 50 05	24,4
SN61		NCS S 4502-Y	100 60 05	28,4
SN62		NCS S 5502-Y	100 50 05	15,1
SN70		NCS S 6005-Y80R	060 50 05	23,1
SN71		NCS S 3005-Y80R	040 70 05	24,2
SN72		NCS S 4005-Y80R	040 60 05	18,3
SN20		NCS S 3010-Y30R	070 80 10	31,7
SN80		NCS S 6010-Y50R	050 40 10	13,5

DAYTONA

Farb-Nr. Colour code		NCS	RAL	LRV
BP20		NCS S 1002-Y50R	080 70 10	40,9
BP70		NCS S 3005-Y50R	060 70 05	34,9
BP60		NCS S 3500-N	000 65 00	32,4
BP90		NCS S 7500-N	000 35 00	8,3

ÉDITION C

Farb-Nr. Colour code		NCS	RAL	LRV
EF00		NCS S 0300N	9003	79,5
EF01		NCS S 0300N	9003	82,5
EF10		NCS S 0603-Y40R	9001	76,3
EF11		NCS S 0603-Y40R	9001	77,9
EF20		NCS S 3010-Y60R	060 70 10	34,9
EF21		NCS S 3010-Y60R	060 70 10	31,5
EF30		NCS S 5040-Y80R	030 30 30	7,6
EF31		NCS S 5040-Y80R	030 30 30	7,1
EF40		NCS S 4550-R70B	290 20 35	3,7
EF41		NCS S 4550-R70B	290 20 35	3,6
EF50		NCS S 2005-G20Y	180 80 05	52,0
EF51		NCS S 2005-G20Y	180 80 05	55,0
EF62		NCS S 3502B	000 70 00	37,4
EF63		NCS S 3502B	000 70 00	34,8
EF64		NCS S 6005-R80B	240 40 05	12,5
EF65		NCS S 6005-R80B	240 40 05	9,9
EF70		NCS S 4005-Y50R	060 60 05	28,3
EF71		NCS S 4005-Y50R	060 60 05	25,5
EF90		NCS S 9000N	9004	1,6
EF91		NCS S 9000N	9004	0,5

HUDSON

Farb-Nr. Colour code		NCS	RAL	LRV
SD1L		NCS S 1502-Y50R	000 85 00	51,6
SD1B		NCS S 1502-Y50R	000 85 00	57,6
SD1M		NCS S 1502-Y50R	000 85 00	57,0
SD1R		NCS S 1502-Y50R	000 85 00	56,6
SD2L		NCS S 2005-Y50R	075 80 10	46,3
SD2B		NCS S 2005-Y50R	075 80 10	45,6
SD2M		NCS S 2005-Y50R	075 80 10	44,8
SD2R		NCS S 2005-Y50R	075 80 10	45,0
SD5L		NCS S 3000-N	000 80 00	38,5
SD5B		NCS S 3000-N	000 80 00	40,5
SD5M		NCS S 3000-N	000 80 00	35,9
SD5R		NCS S 3000-N	000 80 00	37,5
SD6L		NCS S 4000-N	000 60 00	27,9
SD6B		NCS S 4000-N	000 60 00	28,0
SD6M		NCS S 4000-N	000 60 00	27,5
SD6R		NCS S 4000-N	000 60 00	27,7
SD7L		NCS S 4005-Y50R	060 60 05	31,8
SD7B		NCS S 4005-Y50R	060 60 05	30,3
SD7M		NCS S 4005-Y50R	060 60 05	28,1
SD7R		NCS S 4005-Y50R	060 60 05	29,5
SD8L		NCS S 7500-N	7024	7,5
SD8B		NCS S 7500-N	7024	7,7
SD8M		NCS S 7500-N	7024	8,0
SD8R		NCS S 7500-N	7024	7,0
SD9L		NCS S 6502-R	000 45 00	13,8
SD9B		NCS S 6502-R	000 45 00	14,5
SD9M		NCS S 6502-R	000 45 00	12,6
SD9R		NCS S 6502-R	000 45 00	12,1

LUCCA

Farb-Nr. Colour code		NCS	RAL	LRV
LS06		NCS S 2502-R	060 70 05	41,9
LS60		NCS S 4502-R	080 60 05	21,9
LS70		NCS S 3005-Y50R	070 70 10	35,1
LS90		NCS S 7000-N	000 40 00	12,2

MARBLE ARCH

Farb-Nr. Colour code		NCS	RAL	LRV
MA00/MA0P/MA01		NCS S 0505-R50B	000 90 00	78,3
MA20/MA2P/MA21		NCS S 0505-R50B	000 90 00	81,0

FARBCODIERUNGEN

MARMOCHIC

Farb-Nr. Colour code		NCS	RAL	LRV
MR00	■ ■ ■ 2	NCS S 0500-N	290 90 05	84,5
MR60	■ ■ ■ 2	NCS S 4502-Y	100 60 05	
MR90	■ ■ ■ 2	NCS S 6502-B	260 40 05	
MR0P/ MR0M	■ ■ ■ 2	NCS S 1000-N	000 85 00	68,3
MR6P/ MR6M	■ ■ ■ 2	NCS S 5502-Y	100 50 05	19,5
MR9P/ MR9M	■ ■ ■ 2	NCS S 6502-B	260 40 05	14,0

MERIDA

Farb-Nr. Colour code		NCS	RAL	LRV
AJ10 (SG)	■ ■ ■ 2	NCS S 1002-Y50R	00 90 05	54,8
AJ60 (SG)	■ ■ ■ 2	NCS S 2002-Y50R	000 80 00	57,7
AJ10 (FSZ)	■ ■ ■ 3	NCS S 2005-Y20R	080 80 05	51,3
AJ20	■ ■ ■ 3	NCS S 2005-Y40R	080 80 10	46,3
AJ60	■ ■ ■ 3	NCS S 4502-Y	080 60 05	29,3
AJ90	■ ■ ■ 3	NCS S 7500-N	000 35 00	8,6

METALYN

Farb-Nr. Colour code		NCS	RAL	LRV
BM00 (SG)	■ ■ ■ 1	NCS S 0500-N	9003	83,2
BM02 (SG)	■ ■ ■ 1	NCS S 0500-N	9003	80,7
BM20 (SG)	■ ■ ■ 2	NCS S 1502-Y50R	080 80 05	49,3
BM22 (SG)	■ ■ ■ 2	NCS S 1502-Y50R	080 80 05	64,2
BM60 (SG)	■ ■ ■ 2	NCS S 1000-N	000 85 00	53,9
BM62 (SG)	■ ■ ■ 2	NCS S 1000-N	000 85 00	64,2
BM90 (SG)	■ ■ ■ 2	NCS S 2502-R	000 75 00	53,9
BM92 (SG)	■ ■ ■ 2	NCS S 2502-R	000 75 00	53,9
BM06	■ ■ ■ 3	NCS S 2500-N	000 70 00	39,3
BM10	■ ■ ■ 3	NCS S 3005-Y50R	080 60 05	20,5
BM40	■ ■ ■ 3	NCS S 4000-N	000 65 00	25,3
BM60	■ ■ ■ 3	NCS S 5500-N	000 50 00	17,5
BM61	■ ■ ■ 3	NCS S 6500-N	000 45 00	15,2
BM70	■ ■ ■ 3	NCS S 4005-Y50R	040 60 05	24,0

METRO FLAIR

Farb-Nr. Colour code		NCS	RAL	LRV
MW00		NCS S 0300-N	9003	84,9
MW10		NCS S 1505-Y50R	060 80 05	55,8
MW90		NCS S 9000-N	9005	0,4

MY EARTH

Farb-Nr. Colour code		NCS	RAL	LRV
RU10	■ ■ ■ 3	NCS S 2005-Y70R	075 80 10	46,3
RU20	■ ■ ■ 3	NCS S 3010-Y50R	060 70 20	41,0
RU60	■ ■ ■ 3	NCS S 4005-Y80R	080 60 05	28,9
RU90	■ ■ ■ 3	NCS S 7005-R50B	000 35 00	12,8

NATURAL BLEND

Farb-Nr. Colour code		NCS	RAL	LRV
LY00	■ ■ ■ 2	NCS S 1000-N	000 90 00	
LY10	■ ■ ■ 2	NCS S 1005-Y50R	090 90 05	
LY20	■ ■ ■ 3	NCS S 1502-Y50R	080 80 05	60,0
LY60	■ ■ ■ 3	NCS S 3000-N	000 70 00	35,0

NOCTURNE

Farb-Nr. Colour code		NCS	RAL	LRV
ZN1L/ ZN1P	■ ■ ■ 3	NCS S 0500-N	9003	68,5
ZN2L/ ZN2P	■ ■ ■ 3	NCS S 1002-Y	9002	62,8
ZN9L/ ZN9P	■ ■ ■ 3	NCS S 7502-B	000 25 00	

OAK PARK

Farb-Nr. Colour code		NCS	RAL	LRV
HR00	■ ■ ■ 2	NCS S 2005-Y50R	075 80 10	48,1
HR10	■ ■ ■ 2	NCS S 2005-Y80R	060 70 10	39,3
HR20	■ ■ ■ 2	NCS S 3010-Y30R	070 70 20	32,7
HR30	■ ■ ■ 2	NCS S 4020-Y50R	060 60 20	18,5
HR80	■ ■ ■ 2	NCS S 5010-Y50R	050 50 10	17,6

OAK SIDE

Farb-Nr. Colour code		NCS	RAL	LRV
HE00	■ ■ ■ 1	NCS S 0500-N	000 90 00	
HE10 (SG)	■ ■ ■ 1	NCS S 1005-Y20R	090 90 05	
HE10 (FSZ)	■ ■ ■ 2	NCS S 3020-Y30R	060 60 20	26,9
HE20	■ ■ ■ 2	NCS S 3030-Y30R	060 60 30	26,1
HE30	■ ■ ■ 2	NCS S 5020-Y40R	060 50 30	17,4
HE80	■ ■ ■ 2	NCS S 6020-Y90R	050 30 20	7,7

OMBRA

Farb-Nr. Colour code		NCS	RAL	LRV
IA01	■ ■ ■ 1	NCS S 1000-N	000 90 00	
IA03	■ ■ ■ 1	NCS S 2500-N	000 70 00	
IA31	■ ■ ■ 1	NCS S 2500-N	000 70 00	
IA12	■ ■ ■ 1	NCS S 1000-N	000 90 00	
IA32	■ ■ ■ 1	NCS S 2500-N	000 70 00	

OHIO

Farb-Nr. Colour code		NCS	RAL	LRV
CJ10 (SG)	■ ■ ■ 2	NCS 1005-Y40R	090 90 05	53,6
CJ60 (SG)	■ ■ ■ 2	NCS S 1000-N	000 90 00	51,6
CJ10 (FSZ)	■ ■ ■ 2	NCS S 1505-Y20R	100 90 05	
CJ20	■ ■ ■ 2	NCS S 2005-Y50R	060 70 10	32,2
CJ60 (FSZ)	■ ■ ■ 2	NCS S 1500-N	000 85 00	
CJ61	■ ■ ■ 2	NCS S 3000-N	000 60 00	31,1
CJ62	■ ■ ■ 2	NCS S 7000-N	000 35 00	10,3

PIER 45

Farb-Nr. Colour code		NCS	RAL	LRV
BR60	■ ■ ■ 3	NCS S 2502-Y	000 80 00	46,5
BR80	■ ■ ■ 3	NCS S 4005-Y20R	070 60 10	26,0
BR90	■ ■ ■ 3	NCS S 5502-Y	000 50 00	17,7

PRO ARCHITECTURA 3.0

Farb-Nr. Colour code		NCS	RAL	LRV
C000		NCS S 0500-N	9003	77,9
C010		NCS S 1002-Y	090 85 05	76,7
C011		NCS S 1005-Y10R	090 85 10	74,1
C032		NCS S 1010-R	040 85 05	65,3
C034		NCS S 2020-R20B	360 70 15	39,5
C041		NCS S 1510-B	240 80 05	66,0
C053		NCS S 1010-G	170 85 10	68,5
C060		NCS S 2500-N	000 75 00	52,8
C061		NCS S 5000-N	000 60 00	26,7
C070		NCS S 3005-Y50R	060 70 05	42,4
C071		NCS S 5005-Y50R	040 60 05	27,5
C072		NCS S 7005-R20B	320 40 05	13,4
C090		NCS S 7500-N	000 35 00	8,1
C091		NCS S 9000-N	000 15 00	2,7
C100		NCS S 0500-N	9003	81,2
C110		NCS S 1002-Y	090 85 05	80,8
C111		NCS S 1005-Y10R	090 85 10	75,0
C122		NCS S 1060-Y	090 80 60	60,6
C125		NCS S 1070-Y60R	050 60 60	34,3
C127		NCS S 2010-Y40R	070 70 20	43,1
C130		NCS S 1580-Y90R	030 40 60	10,7
C132		NCS S 1010-R	040 85 05	66,0
C134		NCS S 2020-R20B	360 70 15	38,6
C138		NCS S 8005-R20B	340 20 05	2,4
C139		NCS S 5040-R	020 30 30	6,8
C141		NCS S 1510-B	240 80 05	63,7
C145		NCS S 5045-B10G	220 30 25	6,5
C149		NCS S 4550-R70B	290 20 35	4,0
C150		NCS S 4040-G	160 50 30	16,7
C152		NCS S 2050-G30Y	120 70 40	43,2
C153		NCS S 1010-G	170 85 10	70,8
C154		NCS S 3030-B30G	200 60 20	28,4
C160		NCS S 2500-N	000 75 00	51,8
C161		NCS S 5000-N	000 60 00	24,9

COLOUR CODES

PRO ARCHITECTURA 3.0

Farb-Nr. Colour code	NCS	RAL	LRV
C170	NCS S 3005-Y50R	060 70 05	41,1
C171	NCS S 5005-Y50R	040 60 05	23,6
C172	NCS S 7005-R20B	320 40 05	11,9
C190	NCS S 7500-N	000 35 00	5,8
C191	NCS S 9000-N	000 15 00	0,4
C211	NCS S 1005-Y10R	090 85 10	65,0
C221	NCS S 1010-Y	095 85 20	61,7
C227	NCS S 2010-Y40R	070 70 20	42,1
C240	NCS S 4040-R80B	270 40 30	7,1
C244	NCS S 1030-R80B	260 70 20	34,8
C245	NCS S 5045-B10G	220 30 25	6,5
C255	NCS S 2030-B50G	190 70 20	37,0
C260	NCS S 2500-N	000 75 00	47,6
C261	NCS S 5000-N	000 60 00	24,3
C264	NCS S 4010-R70B	270 60 10	26,7
C265	NCS S 3005-B80G	180 70 05	40,1
C266	NCS S 7005-R80B	280 40 10	13,2
C270	NCS S 3005-Y50R	060 70 05	34,2
C271	NCS S 5005-Y50R	040 60 05	18,0
C272	NCS S 7005-R20B	320 40 05	11,8
C281	NCS S 5020-Y80R	040 50 20	12,4
C290	NCS S 7500-N	000 35 00	12,5
C291	NCS S 9000-N	000 15 00	3,4
C300	NCS S 0500-N	9003	71,2
C310	NCS S 1002-Y	090 85 05	75,8
C311	NCS S 1005-Y10R	090 85 10	66,0
C320	NCS S 1070-Y10R	080 70 70	41,6
C321	NCS S 1010-Y	095 85 20	71,5
C322	NCS S 1060-Y	090 80 60	57,3
C325	NCS S 1070-Y60R	050 60 60	27,7
C327	NCS S 2010-Y40R	070 70 20	45,6
C330	NCS S 1580-Y90R	030 40 60	10,1
C331	NCS S 1010-R40B	320 85 05	53,1
C332	NCS S 1010-R	040 85 05	64,6
C333	NCS S 2020-Y60R	050 70 20	41,0
C334	NCS S 2020-R20B	360 70 15	33,1
C335	NCS S 3040-Y90R	030 50 30	19,9
C338	NCS S 8005-R20B	340 20 05	3,1
C339	NCS S 5040-R	020 30 30	5,1
C340	NCS S 4040-R80B	270 40 30	9,3
C341	NCS S 1510-B	240 80 05	60,3
C342	NCS S 2040-B	230 60 25	29,5
C344	NCS S 1030-R80B	260 70 20	43,3
C345	NCS S 5045-B10G	220 30 25	6,3
C349	NCS S 4550-R70B	290 20 35	3,1
C350	NCS S 4040-G	160 50 30	17,9
C351	NCS S 1020-G60Y	110 85 20	66,3
C352	NCS S 2050-G30Y	120 70 40	35,5
C353	NCS S 1010-G	170 85 10	61,8
C354	NCS S 3030-B30G	200 60 20	26,7
C355	NCS S 2030-B50G	190 70 20	37,7
C356	NCS S 1020-B70G	170 80 15	53,2
C357	NCS S 3020-G40Y	120 60 20	33,5
C358	NCS S 6530-G50Y	130 40 20	9,6
C360	NCS S 2500-N	000 75 00	47,4
C361	NCS S 5000-N	000 60 00	24,2
C362	NCS S 2005-G50Y	140 80 05	52,3
C363	NCS S 1502-R	300 85 05	55,2
C364	NCS S 4010-R70B	270 60 10	29,4
C365	NCS S 3005-B80G	180 70 05	37,4
C366	NCS S 7005-R80B	280 40 10	8,7
C370	NCS S 3005-Y50R	060 70 05	40,6
C371	NCS S 5005-Y50R	040 60 05	20,3
C372	NCS S 7005-R20B	320 40 05	10,3
C380	NCS S 6030-Y70R	040 30 30	5,7
C381	NCS S 5020-Y80R	040 50 20	14,3
C390	NCS S 7500-N	000 35 00	9,3
C391	NCS S 9000-N	000 15 00	1,5
C411	NCS S 1005-Y10R	090 85 10	64,3

PRO ARCHITECTURA 3.0

Farb-Nr. Colour code	NCS	RAL	LRV
C460	NCS S 2500-N	000 75 00	47,4
C461	NCS S 5000-N	000 60 00	24,4
C464	NCS S 4010-R70B	270 60 10	26,2
C465	NCS S 3005-B80G	180 70 05	40,2
C466	NCS S 7005-R80B	280 40 10	12,9
C471	NCS S 5005-Y50R	040 60 05	19,1
C472	NCS S 7005-R20B	320 40 05	11,9
C490	NCS S 7500-N	000 35 00	15,3
C491	NCS S 9000-N	000 15 00	4,3

PURE BASE

Farb-Nr. Colour code	NCS	RAL	LRV
BT01	■1 NCS S 1000-N	000 90 00	75,0
BT21	■1 NCS S 1002-Y50R	090 90 05	70,3
BZ06	■2 NCS S 3000-N	000 70 00	35,7
BZ10	■2 NCS S 2005-Y50R	060 70 10	40,4
BZ40	■2 NCS S 4000-N	000 60 00	27,9
BZ60	■2 NCS S 5500-N	000 45 00	16,7
BZ70	■2 NCS S 3005-Y50R	060 70 05	34,8

PURE LINE 2.0

Farb-Nr. Colour code	NCS	RAL	LRV
UL10	■1 NCS S 2005-Y30R	085 80 10	53,6
UL60	■1 NCS S 3000-N	000 70 00	37,1
UL61	■1 NCS S 5000-N	000 55 00	23,3
UL62	■1 NCS S 7000-N	000 40 00	10,0
UL70	■1 NCS 3005-Y50R	075 70 10	37,4
UL72	■1 NCS S 5005-Y50R	080 50 05	21,1
UL80	■1 NCS S 7005-Y80R	040 30 05	9,5
UL90	■1 NCS S 8000-N	000 25 00	6,8

RESTONICA

Farb-Nr. Colour code	NCS	RAL	LRV
SJ10	■1 NCS S 1002-Y50R	080 90 05	
SJ70	■1 NCS S 3502-Y	060 70 05	41,0
SJ90	■1 NCS S 5000-N	260 50 05	

ROCKY.ART

Farb-Nr. Colour code	NCS	RAL	LRV
CB10	NCS S 1002-Y50R	9001	75,1
CB00	NCS S 0500-N	9003	82,7
CB70	NCS S 5005-Y50R	080 60 05	23,9
CB60	NCS S 4000-N	000 60 00	26,1
CB10	■2 NCS S 1502-Y50R	080 80 05	56,5
CB70	■2 NCS S 4502-Y	080 60 05	27,9
CB60	■2 NCS S 4000-N	000 60 00	33,2
CB90	■2 NCS S 7000-N	000 40 00	12,7

SILENT MOOD

Farb-Nr. Colour code	NCS	RAL	LRV
CG10	■2 NCS S 1002-Y50R	090 90 05	65,2
CG30	■2 NCS S 1005-R10B	060 90 05	60,7
CG40	■2 NCS S 2005-R90B	220 70 05	41,5
CG50	■2 NCS S 2005-B80G	160 70 05	44,0
CG60	■2 NCS S 1000-N	000 90 00	66,1

SOFT COLOURS

Farb-Nr. Colour code	NCS	RAL	LRV
DS00	■1 NCS 0500-N	9001	80,4
DS10	■1 NCS S 0804-Y50R	080 90 05	75,8
DS20	■1 NCS S 2005-Y40R	080 80 10	51,7
DS30	■1 NCS S 1510-Y80R	040 80 10	54,9
DS40	■1 NCS S 4020-B10G	230 60 10	26,9
DS50	■1 NCS S 3020-G80Y	100 70 20	37,2

FARBCODIERUNGEN

SOLID TONES

Farb-Nr. Colour code		NCS	RAL	LRV
PC10	■ ■ ■ 2	NCS S 2005-Y50R	080 80 05	46,9
PC60	■ ■ ■ 2	NCS S 3000-N	000 75 00	34,2
PC61	■ ■ ■ 2	NCS S 5500-N	000 55 00	19,8
PC62	■ ■ ■ 2	NCS S 7000-N	000 40 00	12,5
PC70	■ ■ ■ 2	NCS S 3005-Y50R	060 70 05	36,6
PS10	■ ■ ■ 2	NCS S 2005-Y50R	080 80 05	45,3
PS60	■ ■ ■ 2	NCS S 3000-N	000 75 00	33,8
PS61	■ ■ ■ 2	NCS S 5500-N	000 55 00	17,8
PS62	■ ■ ■ 3	NCS S 7000-N	000 40 00	11,1
PS70	■ ■ ■ 3	NCS S 3005-Y50R	060 70 05	37,2

SPARKS

Farb-Nr. Colour code		NCS	RAL	LRV
TE60	■ ■ ■ 2	NCS S 3500-N	000 70 00	29,4
TE61	■ ■ ■ 2	NCS S 6500-N	000 40 00	9,3
TE70	■ ■ ■ 2	NCS S 3000-N	000 75 00	25,9
TE90	■ ■ ■ 2	NCS S 8000-N	000 30 00	14,3

SPOTLIGHT

Farb-Nr. Colour code		NCS	RAL	LRV
CM00	■ ■ ■ 2	NCS S 1002-R	000 90 00	75,4
CM60	■ ■ ■ 2	NCS S 0603-R80B	270 90 05	74,9
CM0L	■ ■ ■ 2	NCS S 1002-R	000 85 00	65,4
CM0M	■ ■ ■ 2	NCS S 1002-R	000 85 00	64,1
CM6L	■ ■ ■ 2	NCS S 2005-N	000 70 00	35,0
CM6M	■ ■ ■ 2	NCS S 2005-N	000 70 00	34,9
CM7L	■ ■ ■ 2	NCS S 1502-R	000 80 00	51,2
CM7M	■ ■ ■ 2	NCS S 1502-R	000 80 00	55,4
CM9L	■ ■ ■ 2	NCS S 6000-N	000 45 00	7,6
CM9M	■ ■ ■ 2	NCS S 6000-N	000 45 00	11,7

STAGEART

Farb-Nr. Colour code		NCS	RAL	LRV
SA10	■ ■ ■ 3	NCS S 2005-Y50R	095 80 10	45,6
SA60	■ ■ ■ 3	NCS S 2000-N	000 80 00	42,8
SA20	■ ■ ■ 3	NCS S 2002-Y50R	100 80 05	38,5
SA60	■ ■ ■ 3	NCS S 2500-N	000 75 00	36,5
SA61	■ ■ ■ 3	NCS S 4000-N	000 60 00	27,0
SA80	■ ■ ■ 3	NCS S 7000-N	000 40 00	9,9

UNIT ONE

Farb-Nr. Colour code		NCS	RAL	LRV
UT01		NCS S 0907-R30B	000 90 00	72,2
UT02		NCS S 2005-R80B	000 75 00	42,3
UT03		NCS S 0603-Y80R	075 90 05	69,7
UT21		NCS S 0507-R20B	9010	72,2
UT22		NCS S 2005-R80B	000 75 00	40,8
UT41		NCS S 2005-Y70R	050 80 10	51,2
UT42		NCS S 4502-R	000 65 00	22,2

UNIT TWO

Farb-Nr. Colour code		NCS	RAL	LRV
TW01		NCS S 0603-R60B	9010	76,2
TW02		NCS S 0603-R60B	9010	76,7
TW03		NCS S 0502-R	9001	78,8
TW04		NCS S 0502-R	9001	73,4

UNIT THREE

Farb-Nr. Colour code		NCS	RAL	LRV
GT10	■ ■ ■ 1	NCS S 1505-Y30R	110 90 05	57,7
GK10	■ ■ ■ 1	NCS S 1505-Y30R	110 90 05	58,0
GT20	■ ■ ■ 1	NCS S 2005-Y50R	075 80 10	46,8
GK20	■ ■ ■ 1	NCS S 2005-Y50R	075 80 10	45,1
GT30	■ ■ ■ 1	NCS S 2502-Y	060 70 05	36,9
GK30	■ ■ ■ 1	NCS S 2502-Y	060 70 05	35,6
GT50	■ ■ ■ 1	NCS S 5502-R	260 50 05	15,0
GK50	■ ■ ■ 1	NCS S 5502-R	260 50 05	14,7

UNIT FOUR

Farb-Nr. Colour code		NCS	RAL	LRV
CT10	■ ■ ■ 2	NCS S 1505-Y50R	060 80 10	50,8
CT60	■ ■ ■ 2	NCS S 2002-Y50R	100 70 05	38,2
CT61	■ ■ ■ 2	NCS S 5005-Y20R	100 50 05	17,2
CT62	■ ■ ■ 2	NCS S 6502-Y	000 45 00	12,1
CT70	■ ■ ■ 2	NCS S 3010-Y40R	050 70 10	33,3
CT80	■ ■ ■ 2	NCS S 6010-Y50R	040 40 10	11,4

UNIT FOUR WALL

Farb-Nr. Colour code		NCS	RAL	LRV
CT10	■ ■ ■ 1	NCS S 0804-Y50R	090 90 05	64,8
CT60	■ ■ ■ 1	NCS S 1002-R	000 85 00	63,2

URBAN ART

Farb-Nr. Colour code		NCS	RAL	LRV
UA00	■ ■ ■ 3	NCS S 1502-Y50R	090 90 05	
UA20	■ ■ ■ 3	NCS S 2040-Y30R	060 60 40	
UA30	■ ■ ■ 3	NCS S 5030-Y80R	040 30 30	
UA40	■ ■ ■ 3	NCS S 6020-R80B	260 30 20	
UA50	■ ■ ■ 3	NCS S 4020-G80Y	100 60 20	
UA70	■ ■ ■ 3	NCS S 6005-Y50R	050 50 10	

URBAN JUNGLE

Farb-Nr. Colour code		NCS	RAL	LRV
TC00	■ ■ ■ 2	NCS S 1000-N	000 90 00	
TC20	■ ■ ■ 2	NCS S 1002-R	110 90 05	
TC10	■ ■ ■ 2	NCS S 1502-R	000 80 00	42,8
TC60	■ ■ ■ 2	NCS S 4502-R	000 60 00	26,4
TC70	■ ■ ■ 2	NCS S 3005-Y50R	060 70 05	36,9
TC90	■ ■ ■ 2	NCS S 5502-R	000 55 00	16,6

URBANTONES

Farb-Nr. Colour code		NCS	RAL	LRV
LI00		NCS S 3000-N	9003	78,4
LI01		NCS S 3000-N	9003	82,1

VICTORIAN

Farb-Nr. Colour code		NCS	RAL	LRV
MK1P/MK00	■ ■ ■ 2	NCS S 0505-R70B	000 90 00	63,8
MK9P/MK90	■ ■ ■ 2	NCS S 8500-N	000 25 00	7,7

WHITE & CREAM

Farb-Nr. Colour code		NCS	RAL	LRV
SW00		NCS S 0500-N	9003	77,6
SW01		NCS S 0500-N	9003	81,5
SW02		NCS S 0500-N	9003	80,2
SW10		NCS S 1002-Y50R	090 90 05	76,9
SW11		NCS S 1002-Y50R	090 90 05	77,7
SW12		NCS S 1002-Y50R	090 90 05	77,3

X-PLANE

Farb-Nr. Colour code		NCS	RAL	LRV
ZM00	■ ■ ■ 1	NCS S 1000-N	000 85 00	69,5
ZM10	■ ■ ■ 1	NCS S 2005-Y50R	090 90 05	54,5
ZM20	■ ■ ■ 1	NCS S 2010-Y40R	075 80 10	47,9
ZM60	■ ■ ■ 1	NCS S 4000-N	000 55 00	22,9
ZM70	■ ■ ■ 1	NCS S 4005-Y50R	060 60 05	27,3
ZM90	■ ■ ■ 1	NCS S 6000-N	000 40 00	11,2
ZM91	■ ■ ■ 1	NCS S 7500-N	000 35 00	7,0

GENERAL INFORMATION

Calibrated tiles

After manufacture, the edges of calibrated tiles, marked with the symbol , are additionally ground so that the sides are at an angle of 90° to the surface. On rectified tiles from Villeroy & Boch the top edge is additionally angled slightly. This is referred to as a bevelled edge. The bevelled edge serves to avoid risks of injury. Bevelled edges can make joints look wider.

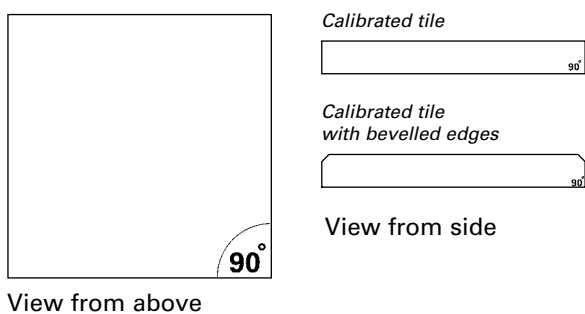

View from above

Colour nuances and coloration

Ceramic tiles are made from natural raw materials and therefore vary in terms of surface finish to a certain extent within standard tolerances. Minor differences in colour, décor, structure, gloss or surface roughness may occur. However, many tile ranges require an even visual effect and differences in nuance would adversely affect the overall appearance. The tiles are therefore sorted by “nuance” (only Grade 1), and labeled and boxed separately.



The nuance is identified by a code of two figures followed by a letter, e.g. 45 X. Tiles with different nuances should not be used together. To compensate for any remaining differences of shading within one nuance, the contents of the boxes should be checked before tiling and the tiles mixed as necessary, i.e. tiles from several boxes laid alternately. In some tile ranges, floor tiles in particular, the colour-play is an integral part of the character of the range and intentional. That is to say, based on an average colour shade and brightness (nuance code), tiles of differing colour shades, structures and brightness are intentionally chosen for combination. In such cases, differences in colour shading are intentional and not reason for complaint. For a varied, yet balanced overall effect, we recommend checking boxes from these tile ranges, too, and mixing the tiles when laying.

Where basic tiles and decor tiles from the same range are used together it is essential that the nuance codes match.

The first two figures should always be identical. Not always a

letter is indicated for decor tiles. In the case, there is a letter than it has to be identical to that of the basic tiles.

Craquelé formation / Crazing

Craquelé refers to the fine hairline cracks to be found in the glaze of nonvitreous tiles and glass plating. On many articles the hairline cracks are a desired and intentional effect and not a cause for complaints. Articles which may develop hairline cracks in the glaze are indicated by  .

Frost resistance in compliance with EN ISO 10545-12

Main criterion for using tiles outdoors. Required, according to EN 14411 Group BIa for porcelain stoneware and EN 14411 Group BIb for vitreous tiles.

Frost damage can occur, however, even with tiles complying with standards, if they are laid incorrectly or on defective substrate.

Glazed edge

Tiling a wall with basic tiles with glazed edges has various advantages in terms of hygiene and aesthetic edges and corners. Villeroy & Boch produces basic tiles with one glazed edge for the entire nonvitreous range (except for a few of the large formats and rectified tiles). The relevant articles are indicated by the symbol .

Glazed vitreous tiles (up to format 10 x 30 cm/20 x 20 cm), which are frequently used for wall coverings, are also produced and supplied with one glazed edge. 20% of the packages on a pallet contain tiles with glazed edges.

These boxes are marked accordingly.

GENERAL INFORMATION

Modular tiling

Villeroy & Boch tile ranges are normally modular, i.e. tiles of different formats can be laid together in a modular format, if the nominal dimension is taken into account. Tiles of the same calibre can be laid with a uniform joint width.

Wall and floor tiles of different calibres can be laid in line with different joint widths if the nominal dimension is taken into account. Tiles of different thicknesses can normally be combined. We recommend that differences in tile thickness of more than 1 mm be compensated.

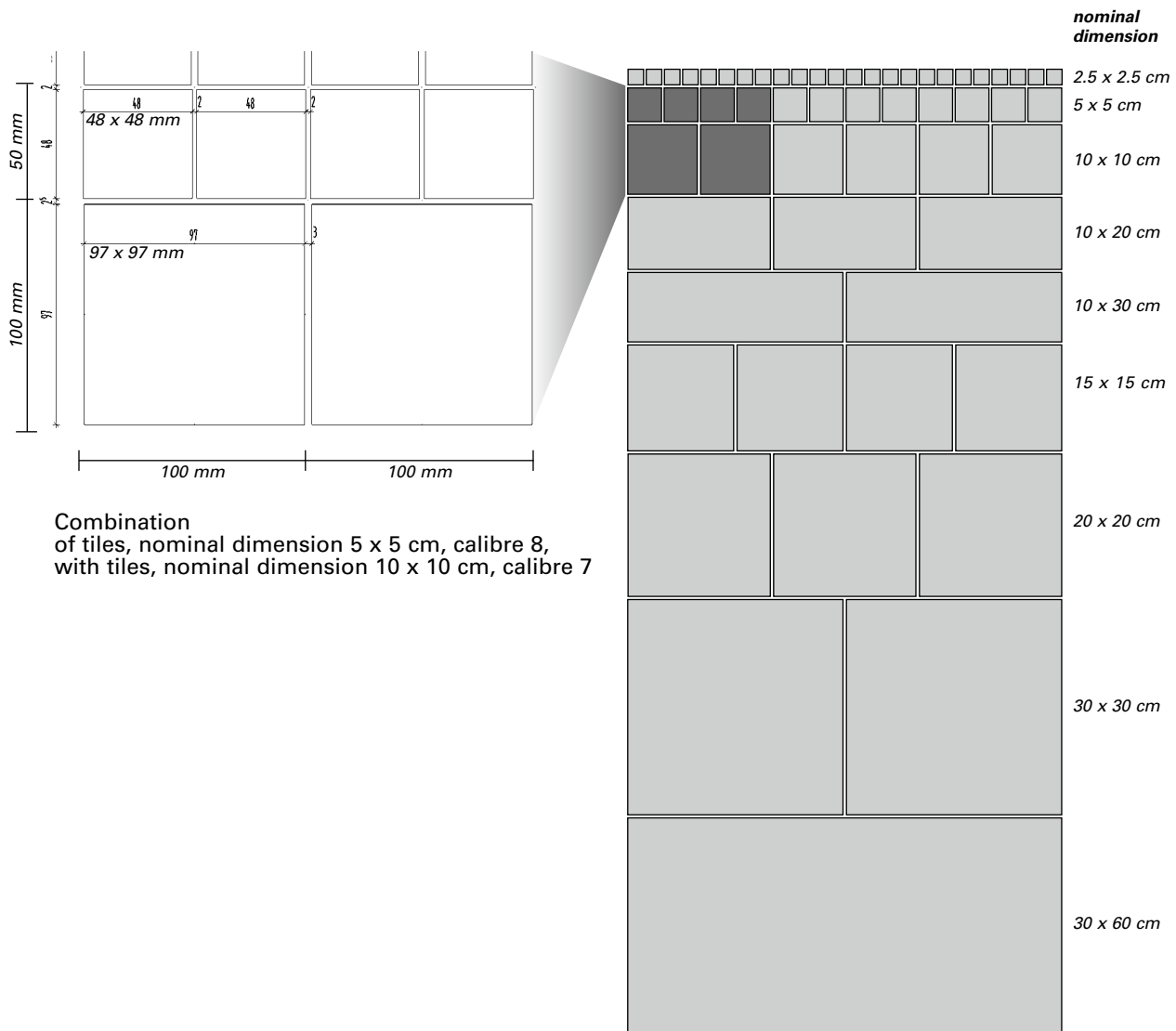

GENERAL INFORMATION

Sheet-mounting

Small-format tiles up to a format of 10 x 10 cm are mounted on sheets in the relevant tile grid.

They are always delivered with a glass fibre backing. As a rule, the provision of loose tiles has to be agreed in advance.

Sheet-mounted tiles should always be stored in a dry place.

For delivery of loose tiles in special cases there will be an additional charge of 10%.

Tile sizes

The tile format is given as a nominal dimension, which is made up of the work size (aspired manufacturing size) plus the recommended joint width. In the industrial manufacture of tiles, variations in the size (calibre) of the tiles are inevitable. The sizes are sorted, labelled and boxed separately.

The calibre code is stated on every package next to the shade code and specifies the actual size of the tile.

Example: For a tile in format 30 x 30 cm with work size 296 x 296 mm, the following general calibre data will be stated on every package:

Calibre Code	
295 x 295 mm	5
296 x 296 mm	6
297 x 297 mm	7

Examples for actual tile size:

Nominal dimension:

30 x 30 cm

Work size: 296 x 296 mm

Calibre 7

Actual size:

297 x 297 mm

Joint width: 3 mm

Printing on the box

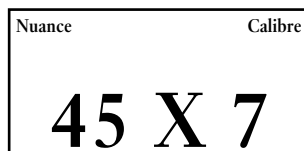

Nominal dimension:

30 x 30 cm

Work size: 296 x 296 mm

Calibre 6

Actual size:

296 x 296 mm

Joint width: 4 mm

Printing on the box

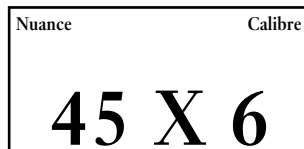



Weights

The stated weights are average weights.

ALLGEMEINES

Craquelébildung

Unter Craquelé versteht man feine Haarrisse in der Glasur von Fliesen und in Glasauflagen. Die Craquelébildung ist bei vielen Artikeln ein gewünschter und bewusst herbeigeführter Effekt und kein Reklamationsgrund.

Artikel, bei denen eine Craquelébildung möglich ist, sind mit den Symbolen   gekennzeichnet.

Farbnuancen und Farbspiel

Keramische Fliesen werden aus natürlichen Rohstoffen hergestellt, sind farb- und lichtecht, und unterliegen innerhalb der Normanforderungen gewissen Schwankungen in der Oberfläche. Es entstehen geringe Unterschiede in Farbe, Dekormuster, Struktur, Glanz oder Oberflächenrauigkeit. Bei vielen Fliesenserien ist aber ein gleichmäßiger optischer Eindruck erwünscht und Nuancenunterschiede wirken im Belag störend. Deshalb werden diese Fliesen (nur 1. Sorte) nach sogenannten Farbnuancen sortiert, gekennzeichnet und getrennt verpackt.

Die Nuance wird mit einer zweistelligen Zahl und einem Buchstaben gekennzeichnet, z.B. 45 X. Fliesen mit unterschiedlichen Nuancen empfehlen wir, nicht zusammen zu verlegen. Um noch bestehende geringste Farbunterschiede innerhalb einer Nuance im Belag auszugleichen, sollten vor der Verlegung die Pakete geprüft und dann gemischt, das heißt aus mehreren Paketen wechselnd verlegt werden.

Bei manchen Fliesenserien, vor allem bei Bodenfliesen, gehört ein Farbspiel in der Fläche zum Charakter der Fliesenserie und wird gezielt herbeigeführt. Das heißt, ausgehend von einer mittleren Farbnuance und Helligkeit (Nuancenangabe) gehören bewusst Fliesen mit davon abweichenden Farbnuancen, Strukturen und Helligkeiten zum Belag und werden miteinander kombiniert verlegt. Nuancenunterschiede sind somit gewünscht und kein Reklamationsgrund.

Für einen abwechslungsreichen, ausgewogenen Gesamteindruck empfiehlt es sich bei diesen Fliesenserien ebenfalls, vor der Verlegung die Pakete zu prüfen und gemischt zu verlegen. Werden Grundfliesen und Dekorfliesen einer Serie eingesetzt, ist darauf zu achten, dass die Nuancenzeichnungen übereinstimmen. Die ersten zwei Ziffern sind immer vorhanden und sollen gleich sein. Nicht immer sind bei Dekoren Buchstaben angegeben. Wenn doch, müssen auch diese übereinstimmen.

Fliesengröße

Formate von Fliesen werden im Nennmaß angegeben, das sich aus dem Werksmaß (angestrebtes Fertigungsmaß) und der Fugenbreite zusammensetzt. In der industriellen Herstellung von Fliesen kommt es zu Schwankungen in der Größe, dem Fliesen-Kaliber.

Diese Kaliber werden sortiert, gekennzeichnet und getrennt verpackt. Der Kalibercode findet sich auf jeder Verpackung neben der Nuancenbezeichnung und gibt somit an, welches tatsächliche Maß die Fliese hat.

Beispiel: Bei einer Fliese mit dem Format 30 x 30 cm und Werksmaß 296 x 296 mm sind folgende allgemeine Kaliberangaben auf jedem Paket aufgedruckt:

Caliber Code	
295 x 295 mm	5
296 x 296 mm	6
297 x 297 mm	7

Beispiele für die tatsächliche Fliesengröße:

Nennmaß: 30 x 30 cm
 Paketaufdruck
 Werksmaß: 296 x 296 mm
 Kaliber 7
 Tatsächliches Maß:
 297 x 297 mm
 Fugenbreite: 3 mm

Nuance	Caliber
45	X 7

Nennmaß: 30 x 30 cm
 Paketaufdruck
 Werksmaß: 296 x 296 mm
 Kaliber 6
 Tatsächliches Maß:
 296 x 296 mm
 Fugenbreite: 4 mm

Nuance	Caliber
45	X 6

Frostbeständigkeit nach EN ISO 10545-12

Haupteignungskriterium für die Verwendung von Fliesen im Außenbereich. Diese ist für Feinsteinzeug nach EN 14411 Gruppe BIa und Steinzeugfliesen nach EN 14411 Gruppe BIb gefordert.

Unsachgemäße Verlegung oder Verlegung auf mangelhaften Untergründen können Frostschäden auch bei normgerechten Fliesen verursachen.

Gewichte

Bei den angegebenen Gewichten handelt es sich um Durchschnittsgewichte.

ALLGEMEINES

Glasierte Kante

Die Verwendung von Grundfliesen mit glasierten Kanten an der Wand bringt mehrere Vorteile in Hinsicht auf Hygiene und die Ästhetik von Kanten und Ecken.

Bei Steingutfliesen produziert Villeroy & Boch Grundfliesen mit einer glasierten Kante über das ganze Sortiment (außer bei einigen Großformaten und rektifizierten Fliesen).

Die entsprechenden Produkte sind mit dem Symbol  gekennzeichnet.

Glasiertes Steinzeug bis zum Format 10 x 30 cm bzw. 20 x 20 cm, das häufig für Wandbeläge verwendet wird, wird ebenfalls mit einer glasierten Kante produziert und geliefert. 20% der Pakete auf einer Palette beinhalten Fliesen mit glasierten Kanten. Diese Pakete sind entsprechend gekennzeichnet.

Modul(are) Fliesen

Fliesenserien von Villeroy & Boch sind im Regelfall modular, d.h. Fliesen unterschiedlicher Formate können unter Berücksichtigung des Nennmaßes in einem Raster miteinander verlegt werden. Fliesen mit gleichem Kaliber können mit einheitlicher Fugenbreite verlegt werden.

Wand- und Bodenfliesen mit verschiedenen Kalibern sind bei Einhaltung des Nennmaßes mit unterschiedlicher Fugenbreite im Fugenschnitt verlegbar. Generell sind Fliesen mit verschiedenen Fliesenstärken kombinierbar. Unterschiede in der Fliesenstärke von mehr als 1 mm empfehlen wir auszugleichen.

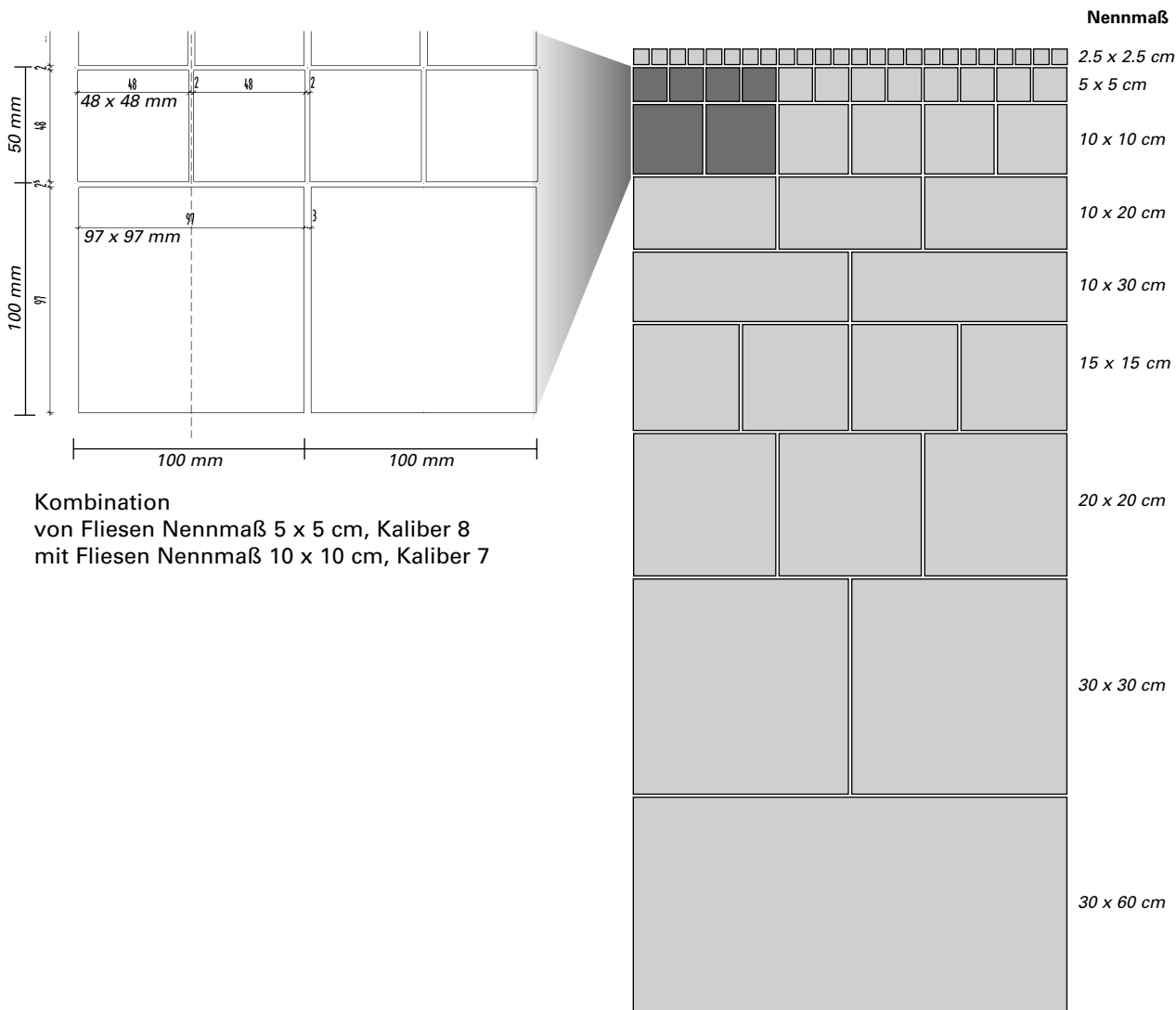

ALLGEMEINES

Rektifizierte Fliesen / Gefaste Kanten

Rektifizierte Fliesen, mit dem Symbol  gekennzeichnet, werden nach der Herstellung zusätzlich an den Kanten geschliffen, so dass die Seitenflächen in einem 90° Winkel zur Oberfläche stehen. Bei Fliesen von Villeroy & Boch wird die obere Kante bei rektifizierten Fliesen zusätzlich leicht abgeschragt, man spricht dann von gefasten Kanten. Dies dient der Vorbeugung vor Verletzungsgefahren. Gefaste Kanten können Fugen optisch breiter aussehen lassen.

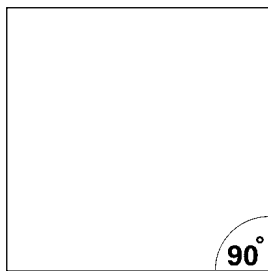

Aufsicht

Rektifizierte Fliese



Rektifizierte Fliese
mit gefasten Kanten

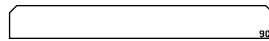

Seitenansicht

Tafelklebung

Kleinformatische Fliesen bis Format 10 x 10 cm werden zu Tafeln im entsprechenden Fliesenraster zusammen geführt. Die Lieferung erfolgt grundsätzlich mit rückseitiger Glasfaserklebung. Grundsätzlich ist die Bereitstellung loser Fliesen erst abzuklären. Fliesen mit Tafelklebung sollten generell trocken gelagert werden. Für die, in Sonderfällen, gewünschte Lieferform von losen Fliesen wird ein Aufschlag von 10% berechnet.

ALLGEMEINE VERKAUFS-, LIEFERUNGS- UND ZAHLUNGSBEDINGUNGEN

§ 1 Geltungsbereich

1. Diese Allgemeinen Verkaufs-, Lieferungs- und Zahlungsbedingungen (im Folgenden: AGB) gelten für alle Angebote, Verkäufe und Lieferungen der V&B Fliesen GmbH (im Folgenden: V&B). Die AGB gelten nur gegenüber Kaufleuten, juristischen Personen des öffentlichen Rechts oder einem öffentlich-rechtlichen Sondervermögen.
2. Diese AGB gelten, soweit nicht ausdrücklich etwas anderes bestimmt ist, für die gesamte Dauer der Geschäftsbeziehung, ohne dass wir hierauf ausdrücklich Bezug nehmen müssen. Andere Bedingungen wie diese, insbesondere Einkaufsbedingungen des Kunden, gelten nicht, auch wenn sie nicht ausdrücklich zurückgewiesen werden. Diese AGB gelten auch dann, wenn wir in Kenntnis entgegenstehender oder von unseren AGB abweichenden Bedingungen des Kunden die Lieferung an den Kunden vorbehaltlos ausführen.
3. Jede Abweichung (Änderung/Ergänzung) von diesen Bedingungen bedarf der Schriftform.

§ 2 Preise, Rabatte, Zahlungsbedingungen

1. Soweit nicht anders vereinbart, gelten für alle Verkäufe und Lieferungen der V&B deren jeweils zum Zeitpunkt des Vertragsschlusses angebotsweise mitgeteilten Preise zuzüglich Umsatzsteuer in gesetzlicher Höhe. Rabatte werden jeweils auf die fakturierten Bruttopreise gewährt. Boni werden auf den Nettowarenwert gewährt. Wird der Nettowarenwert nicht ausgehend von der jeweils gültigen Brutto-Preisliste ermittelt, wird auf den Umsatz kein Bonus gewährt.
2. Soweit nicht anders vereinbart, verstehen sich alle Preise für Waren ab Lager sowie zuzüglich Verpackungs-, Versand-, Transport- und Versicherungskosten, Zölle, Steuern, Gebühren und sonstige Abgaben, die im Zusammenhang mit dem Verkauf und der Lieferung der Ware an den Kunden anfallen können (in Folgenden: Lieferkosten).
3. Sämtliche Lieferkosten trägt der Kunde bis zu einem Frachtgewicht von 3t. V&B weist die Lieferkosten gesondert aus. Der Kunde trägt die Transportkosten ab Lager und die Kosten einer ggf. vom Kunden gesondert beauftragten Transportversicherung. Erfüllt V&B den Auftrag durch Teillieferungen, trägt der Kunde die Lieferkosten für sämtliche Teillieferungen. Ab einem Frachtgewicht von 3t liefert V&B frei Haus. Individuelle Vereinbarungen bleiben von dieser Regelung unberührt.
4. Die Berechnung des Quadratmeterpreises von Fliesen erfolgt auf Basis der Angaben für das Nennmaß.
5. Die Parteien können Preisanpassungen (Preiserhöhungen und Preisreduktionen) durch schriftliche Mitteilung gegenüber der jeweils anderen Partei bis zu 7 Tage vor Lieferung für den Fall und in dem Umfang vornehmen, soweit es für die jeweilige Partei nach Vertragsschluss zu unvorhersehbaren Kostenveränderungen kommt, z.B. aufgrund von
 - durch den Kunden veranlasste Änderungen in Bezug auf den Umfang, die Art und Weise der Lieferung, den Liefertermin und/oder sonstige kostenrelevante Faktoren;
 - Verzögerungen, die durch Weisungen oder ein sonstiges Verhalten des Kunden entstehen;
 - seitens des Kunden nicht, nicht rechtzeitig, nicht zutreffend, nicht vollständig und/oder in sonstiger Weise nicht ausreichend erteilten Informationen, Anweisungen und/oder sonstigen Mitwirkungshandlungen;
 - erheblichen wirtschaftlichen Umständen, die sich der Kontrolle und/oder Einflussmöglichkeit beider Parteien entziehen, z.B. Wechselkursschwankungen, Steuer- oder Abgabenänderungen, Änderungen von externen Arbeits-, Material-, Energie-, Produktbeschaffungs- oder Herstellungskosten, wenn diese Kosten die Warenherstellungs-, Beschaffungs- oder Kosten der vertraglich vereinbarten Leistung unmittelbar oder mittelbar beeinflussen und die Lieferung mehr als zwei Monate nach Vertragsschluss erfolgen soll. Die eine Preisanpassung vornehmende Partei hat der jeweils anderen Partei die Umstände der Kostenanpassung auf Verlangen darzustellen. Im Fall einer Preiserhöhung von mehr als 20% in diesem Zeitraum ist jede Partei zum Rücktritt vom Kaufvertrag berechtigt.

Eine Preisanpassung ist jeweils ausgeschlossen, wenn und soweit eine Kostensteigerung durch eine Reduzierung anderweitiger Kosten ausgeglichen wird.

6. Bei Rahmenlieferverträgen, die V&B zur ständigen Lieferbarkeit von Produkten auf Basis gesonderter Bestellungen des Kunden verpflichten, erfolgen Lieferungen zu den Preisen der jeweils bei der jeweiligen Bestellung (Kaufvertragsabschluss) gültigen Preisliste. Die Preisliste wird von V&B jederzeit in aktueller Fassung zur Verfügung gestellt. Preisänderungen bedürfen daher keiner Ankündigung durch V&B.
7. Sofern keine Vorkasse oder eine andere Zahlungsweise vereinbart ist, hat die Zahlung sofort ohne Abzug zu erfolgen. Der Abzug von Skonto bedarf einer gesonderten schriftlichen Vereinbarung. Für die Rechtzeitigkeit der Zahlung ist der Eingang auf dem Geschäftskonto von V&B maßgebend.
8. Mit Ablauf jeder einzelnen der vorstehenden Zahlungsfristen kommt der Kunde in Verzug. Der jeweils fällige Betrag ist während des Verzugs zum jeweils geltenden gesetzlichen Verzugszinssatz zu verzinsen. V&B behält sich die Geltendmachung eines weitergehenden Verzugs Schadens vor. Ein Anspruch auf den kaufmännischen Fälligkeitszins (§ 288 Abs. 2 BGB, § 353 HGB) bleibt unberührt.
9. Die Tilgung mehrerer Forderungen sowie von Hauptforderungen, Zinsen und Kosten erfolgt stets nach den § 366 Abs. 2, § 367 BGB.
10. Wenn die Ware auf Wunsch des Kunden als Sonderanfertigung hergestellt wird, sind wir berechtigt, bis zu 10% mehr zu liefern, ohne dass dies als Pflichtverletzung gilt. Der Kaufpreis ändert sich entsprechend.
11. Dem Kunden stehen Aufrechnungs- oder Zurückbehaltungsrechte nur insoweit zu, als sein Anspruch rechtskräftig festgestellt oder unbestritten ist. Die gesetzlichen Gewährleistungsrechte des Kunden bleiben hiervon unberührt.
12. Wird nach Abschluss des Vertrags erkennbar (z.B. durch Antrag auf Eröffnung eines Insolvenzverfahrens), dass der Anspruch von V&B auf den Rechnungsbetrag (Kaufpreis-, Liefer- und sonstige Kosten) durch mangelnde Leistungsfähigkeit des Kunden gefährdet wird, ist V&B jeweils nach den gesetzlichen Vorschriften zur Leistungsverweigerung und zum Rücktritt vom Vertrag berechtigt (§ 321 BGB).
13. Im Fall einer Gefährdung des Zahlungsanspruchs durch mangelnde Leistungsfähigkeit des Kunden ist V&B ebenfalls berechtigt, noch ausstehende Lieferungen und Leistungen nur gegen Vorauszahlung oder Sicherheitsleistung auszuführen. Das gilt auch dann, wenn V&B dem Kunden die Zahlung gestundet oder ihm einen sonstigen Zahlungsaufschub gewährt hat.

§ 3 Angebote

1. Unsere Angebote sind, soweit sie nicht als bindend bezeichnet sind, freibleibend. Bestellungen des Kunden bedürfen zur Rechtswirksamkeit unserer ausdrücklichen schriftlichen Annahme (Auftragsbestätigung). Diese kann innerhalb laufender Geschäftsbeziehung durch die auftragsgemäße Lieferung der Ware ersetzt werden.
2. Mit Bestätigung des Auftrags bzw. der auftragsgemäßen Lieferung kommt ein Vertrag entsprechend den AGB bzw. eventueller Individualvereinbarungen zu Stande.
3. Wenn nach dem Zustandekommen des Vertrages Änderungen von unseren Kunden gefordert werden oder der Vertrag ganz oder teilweise storniert wird, gehen alle bis dahin entstandenen Kosten und Auslagen sowie die sonstigen uns in diesem Zusammenhang entstehenden Schäden (z.B. entgangener Gewinn) zu Lasten des Kunden. Eine Stornierung ist nur mit unserer Zustimmung möglich.
4. Kommt der Käufer in Annahmeverzug, unterlässt er eine Mitwirkungshandlung oder verzögert sich unsere Lieferung aus anderen, vom Käufer zu vertretenden Gründen, so sind wir berechtigt, Ersatz des hieraus entstehenden Schadens einschließlich Mehraufwendungen (z.B. Lagerkosten) zu verlangen. Beträgt die Verzögerung mehr als 8 Wochen, gerechnet ab Lieferfrist bzw. - mangels einer Lieferfrist - mit der Mitteilung der Versandbereitschaft der Ware, so sind wir berechtigt, pauschale Lagerkosten in Höhe von 0,05 EUR pro angefangenem Monat und pro qm zu berechnen.
5. Der Nachweis eines höheren Schadens und unsere gesetzlichen Ansprüche (insbesondere Ersatz von weiteren Mehraufwendungen, angemessene Entschädigung, Kündigung) bleiben unberührt; die Pauschale ist aber auf weitergehende Geldansprüche anzurechnen. Dem Käufer bleibt der Nachweis gestattet, dass uns überhaupt kein oder nur ein wesentlich geringerer Schaden als vorstehende Pauschale entstanden ist.

ALLGEMEINE VERKAUFS-, LIEFERUNGS- UND ZAHLUNGSBEDINGUNGEN

§ 4 Lieferzeit

1. Liefertermine und Lieferfristen sind nur dann verbindlich, wenn diese als verbindlich ausdrücklich bestätigt wurden.
2. Eine Lieferzeit oder ein Liefertermin ist eingehalten, wenn die Ware bis zum Ablauf die Lieferung unser Werk verlassen hat oder, im Falle der vereinbarten Abholung durch den Kunden, die Versandbereitschaft dem Kunden mitgeteilt ist. Eine Frist oder ein Termin verlängert sich angemessen, wenn von uns nicht zu vertretende Umstände eine Verzögerung bedingen. Hierzu gehören insbesondere höhere Gewalt, Arbeitskämpfe, Verzögerungen der Zulieferer, durch den Kunden verursachte Verzögerungen (etwa durch kundenseitige Änderungen des vereinbarten Lieferumfanges etc.) sowie sonstige Hindernisse, die außerhalb unseres Einflussbereiches liegen.
3. Wir sind berechtigt, Teillieferungen durchzuführen.

§ 5 Gefahrübergang

Lieferungen erfolgen ab Werk als Versendungskauf. Die Gefahr geht mit Übergabe der Ware an den Transporteur auf den Kunden über, und zwar auch dann, wenn Teillieferungen erfolgen. Bei vereinbarter Abholung der Ware durch den Kunden geht die Gefahr mit Bereitstellung der Ware auf den Kunden über. Transportschäden sind unverzüglich dem jeweiligen Dienstleister zur Prüfung anzumelden. Dabei hat sich der Käufer die Beanstandung bescheinigen zu lassen und uns unverzüglich zu melden.

§ 6 Verpackung

Die Verpackung erfolgt nach unserem Ermessen.

§ 7 Versand, Verladung, Fracht

1. Der Versand erfolgt entsprechend der Regelungen in der jeweiligen Preisgruppenübersicht für das Land der Lieferung.
2. Die Kosten für die Verladung der Ware auf LKW oder sonstige Verkehrsmittel sind in unseren Preisen enthalten. Sämtliche darüberhin- ausgehende Ladekosten trägt der Kunde.
3. Fracht- und Verpackungsumsätze werden weder rabattiert noch bonifiziert.

§ 8 Produktqualität

1. Produkte, die als „1. Sorte“ gekennzeichnet sind, entsprechen den Güteanforderungen der Europäischen Qualitätsnormen EN 14411. Produkte, die als „2. Sorte“ gekennzeichnet sind, erfüllen die Anforderungen nach CE-Kennzeichnung, aber nicht alle Anforderungen an vorgenannte Norm und sind mit technischen und/oder optischen Fehlern behaftet, die eine Qualifizierung als „1. Sorte“ ausschließen.
2. Aufgrund der Besonderheiten der keramischen Fertigung kann keine Gewähr dafür übernommen werden, dass die Lieferung in der Farbe gleichmäßig ausfällt oder mit vorgelegten Handmustern übereinstimmt. Insbesondere bei Mosaiken gehört ein Farbspiel häufig zum normalen Erscheinungsbild. Ebenso begründen handelsübliche Toleranzen hinsichtlich Größe und Stärke keinen Mangel. Entsprechendes gilt für Nachlieferungen.
3. Jeder Bodenbelag unterliegt dem Verschleiß. Dieser ist abhängig vom Anwendungsbereich und der Häufigkeit der Begehung, von Art und Grad der Verschmutzung sowie Härte und Verschleißfestigkeit des Belagmaterials. Die Einstufung in Beanspruchungsgruppen bezieht sich auf die Verschleißbeständigkeit der Glasuren, jedoch nicht auf ihre Belastbarkeit durch Druck oder schwere Gewichte.
4. Bei einigen Kunst- und Dekorglasuren gehören Glasurrisse (Craquele) zum Erscheinungsbild. Sie beeinträchtigen nicht den Gebrauchswert der Fliesen und stellen keinen Mangel dar.

§ 9 Rügepflicht, Mitwirkungspflichten

1. Die gelieferte Ware ist gemäß § 377 HGB nach Erhalt unverzüglich auf Richtigkeit, Vollständigkeit und Mängel zu untersuchen. Liegen bei verschrumpften Paletten Anhaltspunkte für Mängel vor, sind die Paletten zu öffnen. Beanstandungen sind unverzüglich, spätestens innerhalb von 14 Tagen schriftlich uns gegenüber anzuzeigen. Mängel, die erst nach Öffnen von Paketen erkennbar sind, müssen ebenfalls innerhalb vorgenannter Frist, in jedem Fall vor Verarbeitung der gelieferten Ware, schriftlich angezeigt werden. Die Verarbeitung mangelhafter

Produkte hat zu unterbleiben. Bei Verletzung der Rügepflicht und bei Verarbeitung gilt die gelieferte Ware als abgenommen und genehmigt.

2. Beanstandete Ware ist in dem Zustand, in dem sie sich zum Zeitpunkt der Feststellung des Mangels befindet, für uns zur Besichtigung bereitzuhalten; eine Verarbeitung ist sofort einzustellen. Die beanstandete Ware ist vom Kunden bis zur Klärung der Reklamation sachgemäß einzulagern. Ein Verstoß gegen die vorstehende Verpflichtung schließt sämtliche Ersatzansprüche uns gegenüber aus.
3. Werden bereits verlegte Fliesen beanstandet, so besteht keine Schadensersatzpflicht, auch wenn der Fehler erst nach Verarbeitung zu erkennen war, wenn und soweit der Belag ohne unsere vorherige schriftliche Einwilligung entfernt wird.
4. Von uns zur Verfügung gestellte Verlegepläne, Mengenauszüge und Entwürfe von Leistungsverzeichnissen müssen von der Bauleitung und der Verlegefirma auf Richtigkeit überprüft werden. Für ihre Richtigkeit wird keine Haftung übernommen. Sie stellen lediglich eine Gefälligkeit dar.

§ 10 Haftung für Produkteigenschaften, Fristen, Verjährung

1. Angaben in Prospekten, Angeboten, Produktbeschreibungen, Zeichnungen, Abbildungen oder sonstigen Erklärungen z. B. im Hinblick auf Maße, Gewichte und sonstige Leistungsdaten sind keine Garantiezusagen, sondern allgemeine Produktbeschreibungen i.S.d. § 8 Nr. 2-4.
2. Entsprechen die von uns gelieferten Produkte nicht der sich aus § 8 ergebenden Produktqualität und sind die Voraussetzungen aus § 9 erfüllt, nehmen wir die mangelhafte Ware zurück und liefern an ihrer Stelle einwandfreie Ware. Wir sind stattdessen berechtigt, dem Kunden unter Ausschluss weitergehender Ansprüche den auf dem Mangel beruhenden Minderwert zu erstatten. Schlägt eine Nachlieferung zweimal fehl und ist eine vom Kunden schriftlich gesetzte, angemessene Frist abgelaufen, so ist der Kunde berechtigt, nach seiner Wahl die Herabsetzung des Kaufpreises zu verlangen oder vom Vertrag zurückzutreten. Rein optische Mängel berechtigen ausschließlich zu einer Wertminderung.
3. Schadenersatzansprüche, gleich aus welchem Rechtsgrund, bestehen nur bei Vorsatz oder grober Fahrlässigkeit unsererseits. Schadenersatzansprüche nach dem Gesetz über die Haftung für fehlerhafte Produkte (Produkthaftungsgesetz) bleiben hiervon unberührt, ebenso die Haftung für Verletzungen von Leben, Körper und Gesundheit sowie die Haftung für die Verletzung vertragswesentlicher Pflichten. Die gesetzlichen Vertreter und deren Erfüllungsgehilfen haften gegenüber dem Käufer, soweit gesetzliche Ansprüche gegen sie erhoben werden können, ebenfalls nur bei Vorsatz oder grober Fahrlässigkeit. Hiervon unberührt bleibt die Haftung für Verletzungen von Leben, Körper und Gesundheit sowie die Haftung für die Verletzung vertragswesentlicher Pflichten.
4. Vorstehende Haftungsbeschränkung gilt ebenfalls nicht, wenn wir für die Beschaffenheit der Ware eine Garantie übernommen haben.
5. Voraussetzung für eine Ersatzleistung ist der Nachweis über die ordnungsgemäße Behandlung entsprechend unserer Nutzungs- und Pflegeanleitungen.
6. Unmittelbare/direkte Folgeschäden ersetzen wir bis zu einer Höchstgrenze von 150.000 EUR je Schadensfall. Die Geltendmachung weiterer Schadenersatzansprüche (z.B. für entgangenen Gewinn, Nutzungsausfall etc.) sind ausgeschlossen.
7. Den Kunden trifft die Verpflichtung, entsprechend § 9 die Ware auf Farbabweichung zu prüfen. Im Falle von Farbabweichungen ist jegliche Gewährleistung ausgeschlossen, sobald die Ware verarbeitet worden ist.
8. Für Folgen nicht fachgerechter Planung und unsachgemäßer Verlegearbeiten, sowie für Schäden durch unsachgemäße Reinigung, insbesondere mittels flusssäurehaltiger Produkte, haften wir gleichfalls nicht.
Für andere als die unter „1. Sorte“ gelieferten Produkte, d.h. Produkte der „2. Sorte“ oder „Mindersortierung“ übernehmen wir keine Gewährleistung, insbesondere nicht für mangelnde Frost- und Säurebeständigkeit, Verschleißverhalten, Glasurrisse etc.
9. Nachträgliche Oberflächenveränderungen durch einen erneuten Brand unserer Erzeugnisse, insbesondere das Aufbringen von Dekoren, bedürfen unserer vorherigen schriftlichen Zustimmung.
10. Unsere Vertragspartner sind verpflichtet, diese Regelung beim Wei-

ALLGEMEINE VERKAUFS-, LIEFERUNGS- UND ZAHLUNGSBEDINGUNGEN

terverkauf unserer Produkte ebenfalls zu vereinbaren. Für Erzeugnisse, die im Sinne dieses Abschnitts weiterverarbeitet werden, übernehmen wir keine Gewährleistung.

11. Unsere Haftung für die Mangelfreiheit unseres Produktes beschränkt sich auf einen Zeitraum von 2 Jahren nach Übergabe an den Kunden. Sollte der Kunde seinerseits nach Verarbeitung der Fliese in ein Bauwerk unter Beachtung der zwischen ihm und seinem Kunden bestehenden Anspruchsfrist berechtigten Ansprüchen ausgesetzt sein, so verzichten wir auf die Einrede der Verjährung für einen Zeitraum von 5 Jahren ab Übergabe an unseren Kunden. Sofern der Kunde eine Inanspruchnahme durch seinen Kunden innerhalb der vorgenannten 5-Jahres-Frist angezeigt hat, verzichten wir weiterhin auf die Einrede der Verjährung bis zum Ablauf von 14 Tagen nach rechtskräftiger Feststellung der Ansprüche gegen unseren Kunden. Mangelfolgeschäden verjähren ausschließlich nach § 634a BGB in 5 Jahren.

§ 11 Urheberrechte

Die von uns veröffentlichten Abbildungen, Berichte und Daten sind größtenteils urheberrechtlich geschützt. Jede vom Urheberrechtsgesetz nicht zugelassene Verwertung bedarf der vorherigen Zustimmung durch uns. Dies gilt insbesondere für Vervielfältigung, Bearbeitung, Übersetzung, Einspeicherung, Verarbeitung bzw. Wiedergabe von Bildern, Produktgestaltungen oder sonstigen Dokumenten.

§ 12 Eigentumsvorbehalt

1. Alle gelieferten Waren bleiben unser Eigentum (Kontokorrentvorbehalt) bis zur vollständigen Erfüllung sämtlicher Forderungen, insbesondere auch der jeweiligen Saldoforderungen, die uns im Rahmen der Geschäftsbeziehungen zustehen. Dies gilt auch für alle aktuellen und künftige oder bedingte Forderungen. Sofern wir Wechsel oder Schecks entgegennehmen, werden unsere Forderungen erst mit der unwiderruflichen Einlösung des Wechsels bzw. Schecks erfüllt.
2. Der Kunde darf die Vorbehaltsware, solange er nicht in Verzug ist, nur im gewöhnlichen Geschäftsverkehr, mit der Sorgfalt eines ordentlichen Kaufmanns, weiterveräußern, sofern er sich das Eigentum gegenüber seinen Kunden vorbehält. Als Weiterveräußerung gilt auch die Verwendung der Vorbehaltsware zur Erfüllung von Werkverträgen. Zu anderen Verfügungen über die von uns gelieferte Ware ist der Kunde vor erfolgter Zahlung nicht berechtigt, insbesondere darf er keine von uns gelieferte Ware an einen Dritten verpfänden oder sicherheitshalber übereignen.
3. Wird die Vorbehaltsware vom Kunden weiterveräußert, verarbeitet/bearbeitet oder vermischt/vermengt, so tritt er uns bereits mit seiner Bestellung bei uns die Forderung aus der Weiterveräußerung, Verarbeitung/Bearbeitung oder Vermischung/Vermengung ab. Wird die Ware zusammen mit anderen Waren weiterveräußert, so wird die Forderung aus der Weiterveräußerung im Verhältnis des Rechnungswertes der Vorbehaltsware zum Rechnungswert der anderen Ware abgetreten.

Der Kunde ist zur Einziehung der auf uns übergegangenen Forderung berechtigt und verpflichtet. Verfügungen über die uns zustehenden Forderungen, die über eine Einziehung hinausgehen, bedürfen unserer vorherigen schriftlichen Zustimmung.

Sofern sich der Kunde in Verzug befindet, können die vorstehenden, in § 12 Nr. 2 und Nr. 3 gewährten Verfügungs- und Einziehungsermächtigungen über die von uns gelieferte Ware von uns jederzeit widerrufen werden. Darüber hinaus sind wir in diesem Fall berechtigt, vom Vertrag zurückzutreten und die unter Kontokorrentvorbehalt gelieferte Ware, solange keine vollständige Erfüllung aller Forderungen besteht, vom Kunden herauszuverlangen.

4. Der Kunde ist sodann verpflichtet, auf unser Verlangen unverzüglich sich jeder weiteren Verfügung über die von uns gelieferte Ware zu enthalten, diese auf seine Kosten sicherzustellen und die gemäß § 12 erfolgte Abtretung dem Drittschuldner mitzuteilen, alle zur Geltendmachung der Forderung gegen den Drittschuldner erforderlichen Mitwirkungshandlungen vorzunehmen und uns eventuell hierfür benötigte Auskünfte und Unterlagen zu überlassen.

Wir sind berechtigt, ab Verzugseintritt die Abnehmer des Kunden von der Abtretung zu unterrichten. Von einer Pfändung oder anderen Beeinträchtigungen durch Dritte muss uns der Kunde unverzüglich benachrichtigen.

5. Übersteigt der Wert der bestehenden Sicherheiten die gesicherten Forderungen insgesamt um mehr als 10%, so sind wir auf Verlangen des Kunden insoweit zur Freigabe von Sicherheiten verpflichtet.

6. Der Kunde ist verpflichtet, an ihn ausgelieferte, aber noch in unserem Eigentum befindliche Ware gegen Feuer und Diebstahl zu versichern und uns auf Verlangen den Abschluss der Versicherung nachzuweisen.

§ 13 Aufrechnung, Abtretung

1. Die Aufrechnung gegen unsere Forderungen ist nur mit von uns anerkannten oder rechtskräftig festgestellten Forderungen möglich.
2. Die Abtretung von gegen uns gerichteten Ansprüchen ist ausgeschlossen.

§ 14 Schlussbestimmungen

(anzuwendendes Recht, Gerichtsstand, salvatorische Klausel)

1. Abschluss, Inhalt, Auslegung und Ergänzung des Vertrages richten sich nach dem Recht der Bundesrepublik Deutschland unter Ausschluss des Übereinkommens der Vereinten Nationen über Verträge über den Internationalen Warenkauf (CISG).
2. Die beiderseitigen Verpflichtungen sind an unserem Sitz zu erfüllen. Ausschließlicher Gerichtsstand für alle Streitigkeiten im Zusammenhang mit unseren Lieferungen oder Leistungen oder aus anderem Zusammenhang mit dem Vertragsverhältnis ist Saarbrücken.
3. Sollten Einzelbestimmungen dieser AGB ganz oder teilweise unwirksam sein oder werden, berührt dies nicht die Wirksamkeit der übrigen Bestimmungen. Anstelle der unwirksamen Bestimmungen gilt, sofern eine Regelungslücke im Gesetz besteht, eine wirksame Regelung, die dem in der unwirksamen Bestimmung zum Ausdruck gekommenen wirtschaftlichen Zweck möglichst nahe kommt.

STANDARD TERMS AND CONDITIONS OF SALE, DELIVERY AND PAYMENT

§ 1 Scope

1. These general terms and conditions of sale, delivery and payment (hereinafter referred to as the Terms and Conditions) shall apply to all offers, sales and deliveries by V&B Fliesen GmbH. These Terms and Conditions shall apply only in relation to merchants, legal persons of public law or special public assets.
2. Unless otherwise expressly agreed these Terms and Conditions shall apply for the entire period of the business relationship without us having to expressly refer to such. Other terms and conditions of a similar nature, in particular the customer's terms and conditions of purchase, shall not apply, irrespective of whether they are expressly rejected. These Terms and Conditions shall also apply if we deliver without reservation notwithstanding knowledge of conditions of the customer at variance to our Terms and Conditions.
3. Any Variation (amendment/ Supplement) to these conditions shall be in writing.

§ 2 Prices, discounts, terms of payment

1. Unless otherwise agreed, all sales and deliveries by V&B shall be subject to the prices quoted by V&B at the time of the conclusion of the contract plus VAT at the statutory rate. Discounts shall be granted on the invoiced gross prices. Bonuses shall be granted on the net value of the goods. If the net value of the goods is not calculated on the basis of the prevailing gross price list, no bonus shall be payable on the transaction.
2. Unless otherwise agreed, all prices for goods are ex warehouse and exclusive of packaging, shipping, transport and insurance costs, customs duties, taxes, fees and other charges that may arise in connection with sales and deliveries of goods to the customer (hereinafter: delivery costs).
3. All delivery costs are borne by the customer up to a freight weight of 3 tons. V&B will specify the delivery costs separately. The customer shall bear the delivery costs ex warehouse and the costs of any transport insurance ordered separately by the customer. If V&B fulfills the order by partial deliveries, the customer shall bear the delivery costs for all partial deliveries. Deliveries are free of charge from a freight weight of 3 tons. Individual agreements remain unaffected by this regulation.
4. The m² tile prices shall be calculated on the basis of the information on the nominal dimensions.
5. The parties may perform price adjustments (price increases and price reductions) by notifying the other party in writing up to 7 days prior to delivery in the event and to the extent that unforeseeable changes in costs occur for the respective party after the conclusion of the contract, e.g. caused by
 - changes initiated by the customer with regard to the scope, manner of delivery, delivery date and/or other cost-relevant factors;
 - delays caused by instructions or other behavior of the customer;
 - information, instructions and/or other acts of cooperation of the customer that are not provided, not provided in a timely manner, not provided accurately, not provided in full and/or otherwise not provided sufficiently;
 - significant economic circumstances beyond the control and/or influence of both parties, e.g. exchange rate fluctuations, changes in taxes or duties, changes in external labor-, material-, energy-, product procurement or manufacturing costs, if these costs directly or indirectly affect the costs of manufacturing goods, procurement or the costs of the contractually agreed performance and the delivery is to take place more than two months after the conclusion of the contract. The price adjusting party will explain the circumstances for changes of costs to the other party upon request. In the event of a price adjustment of more than 20% during this period, either party is entitled to withdraw from the contract.

A price adjustment is excluded in each case if and to the extent that a cost increase is offset by a reduction in other costs.

6. In case of framework supply agreements obligating V&B to continuously deliver products on the basis of separate orders placed by the customer, deliveries shall be made at the prices stated in the price list valid at the time of the respective order (conclusion of the purchase agreement). The price list is available by V&B in its current version at any time. Price adjustments therefore do not require prior notice by V&B.

7. Unless payment in advance or another mode of payment is agreed, payment shall be due immediately without deduction. The deduction of a discount requires a separate written agreement. The date on which payment is credited to our account shall be decisive for determining whether payment has been made on time.
8. Upon expiration of each of the above payment periods, the customer shall be in default. The amount due in each case shall bear interest during the period of default at the applicable statutory default interest rate. V&B reserves the right to assert further damage caused by delay. A claim to the commercial due date interest (§ 288 sect. 2 German Civil Code, § 353 German Commercial Code) remains unaffected.
9. The repayment of several claims and of principal claims, interest and costs shall be made at all times in accordance with § 366 sect. 2 and § 367 German Civil Code.
10. In the event that we have manufactured the goods as custom-made items at the request of the customer, we are entitled to supply as much as 10% more than the agreed volume without this being deemed a breach of obligations. Should this occur, the purchase price is changed accordingly.
11. The customer shall only be entitled to rights of set-off or retention insofar as it's claim has been legally determined or is undisputed. Customer's statutory warranty rights remain unaffected.
12. If, after conclusion of the contract, it becomes apparent (e.g. by filing for insolvency proceedings) that V&B's claim to the payment claim (purchase price, delivery and other costs) is at risk because of the customer's inability to pay, V&B shall in each case be entitled to refuse performance and to withdraw from the contract in accordance with the statutory provisions (§ 321 German Civil Code). V&B shall be entitled to perform outstanding deliveries and services only against advance payment or provision of security.
13. In the event that the payment claim is at risk because of the customer's inability to pay, V&B shall also be entitled to perform outstanding deliveries and services only against advance payment or provision of security. This shall also apply if V&B has deferred payment to the customer or granted the customer any other deferral of payment.

§ 3 Offers

1. Our offers are, unless such are described to be binding, non-binding. Orders placed by the customer shall not become binding until we have expressly accepted these in writing (order confirmation). Within the framework of an ongoing business relationship, this can be replaced by the Provision of goods in accordance with the order.
2. Upon confirmation of the order or Provision of goods in accordance with the order, a contract shall come into being in accordance with the Terms and Conditions and/or any individual agreements.
3. If after the formation of a contract our customer requires amendments or cancel the contract in whole or in part all costs and expenses incurred until such time as well as any other damage resulting (e.g. loss of profit) shall be borne by the customer. Cancellation is possible only with our approval.
4. Should the purchaser be in default of acceptance or fail to perform an Obligation of Cooperation, or should our delivery be delayed by any other reason for which the purchaser is responsible, we shall be entitled to demand compensation for the resulting damages, including any additional expenses incurred (e.g. storage costs). If the delay should exceed eight weeks as calculated from the time at which delivery was due or - should there be no delivery deadline - from the time at which the customer was informed that the goods were ready for shipment, we shall be authorised to Charge the customer for storage costs at a flat rate of EUR 0.05 per square metre for each month or part thereof.
5. The right to assert a Claim for greater damages and our statutory Claims (in particular to compensation for Otter additional expenses incurred, commensurate damages, termination) shall remain unaffected; the flat rate shall however be offset against any further financial Claims. The customer has the right to demonstrate that we did not suffer any damages whatsoever or that the damages we suffered were substantially less than the amount of the aforementioned flat rate.

STANDARD TERMS AND CONDITIONS OF SALE, DELIVERY AND PAYMENT

§ 4 Delivery period

1. We shall be bound by delivery dates and periods quoted only if we have expressly confirmed them as being binding.
2. A delivery date or period shall be deemed to have been complied with if the goods upon such date or upon the expiry of such period the delivery has left our factory or, if it has been agreed that the goods are to be collected by the customer, the customer has been informed that the goods are ready for collection. Such deadline or period shall be reasonably extended in the event of any delay occurring for reasons for which we are not responsible, including but not limited to force majeure, labour disputes, delays on the part of our suppliers, delays for which the customer is responsible (e.g. requests on the part of the customer for changes to the scope of delivery) as well as any other circumstances beyond our control.
3. We shall be authorised to supply the goods in instalments.

§ 5 Transfer of risk

The goods shall be dispatched in accordance with the provisions of Section 447 of the German Civil Code. The risk shall pass to the customer even in the event of instalment deliveries on handing over of the goods to the carrier. If collection of the goods by the customer is agreed, the risk shall pass to the customer when the goods are ready for dispatch. Transport damage shall be reported to the Service provider for verification without delay. The purchaser shall have the complaint certified and shall notify us of it without delay.

§ 6 Packaging

The goods shall be packaged at our discretion.

§ 7 Dispatch, loading and shipment

1. The goods shall always be dispatched in accordance with the regulations in the price group list for the country of delivery.
2. The cost of loading of the goods onto trucks or other means of transport are included in our price. All other costs shall be borne by the customer.
3. Freight and packaging costs shall not be subject to discounts or bonuses.

§ 8 Product quality

1. Products designated as "Grade 1" comply with the quality requirements of European quality Standard DIN EN 14411. Those designated as "Grade 2" comply with the requirements for the CE-symbol but not with the aforementioned Standard and exhibit technical and/or visual defects excluding them from Classification as "Grade 1" products.
2. In view of the special conditions relating to the production of ceramic products, no liability can be assumed if the colour of the goods delivered is not even or if the goods do not exactly match the samples. In mosaics in particular, some colour Variation is to be expected. Similarly, normal tolerances with respect to size and thickness do not constitute flaws. This shall also apply to any subsequent deliveries.
3. All floor coverings are subject to wear and tear depending on where they are used, the frequency of contact, the type and degree of soiling as well as the hardness and wear resistance of the material in question. The Classification in stress groups refers to the resistance to wear of the glazed surface but not to the resistance to strain caused by pressure or heavy objects.
4. In the case of some artistic and decorative glazes, cracks in the glazing are a deliberate effect and do not impair the ability to use the tiles for their intended purpose or constitute a flaw.

§ 9 Complaints, contributory duties

1. The delivered goods shall be inspected immediately upon receipt pursuant to Section 377 of the German Commercial Code to ensure that they are correct, complete and free of any faults. If as a result of damage to pallets there is reason to believe that the goods may be flawed, the pallets in question shall be opened. Any complaints shall be referred to us in writing without delay and at the latest within 14 days. Any flaws that do not become evident until after the boxes have been opened shall also be reported in writing within the aforementioned

period and, in any case, prior to being used. In this case, they may not be used. In the absence of any complaint or if the goods are used, they shall be deemed to have been accepted and free of any flaws.

2. Goods exhibiting flaws shall be made available to us for examination in the condition which they had upon the flaws being discovered. All further use of such goods must be stopped. The customer shall duly store the goods exhibiting flaws until the complaint has been settled. In the event of a violation of the above Obligation, we shall be under no Obligation whatsoever to provide any replacements.
3. If the complaint concerns tiles that have already been laid, we shall not entertain any Claims for damages notwithstanding the fact that the alleged flaws did not become evident until the files had been used, if and to the extent that the tiles are removed without our prior consent.
4. Any laying plans, extracts from quantity lists or draft specifications provided by us shall be examined by the construction manager or the tiling Company to ensure that they are correct. No liability shall be accepted for their correctness. They are provided solely as a convenience.

§ 10 Liability for product characteristics, guarantee periods, Statute of limitations

1. Information contained in brochures, offers, product descriptions, drawings, illustrations or other declarations, e.g. with respect to dimensions, weights or other performance criteria, may not be construed as constituting a binding guarantee but shall merely be deemed to be general product descriptions, liability for which is governed by Section 8 nos. 2 - 4 of these Terms and Conditions.
2. If the products supplied by us do not comply with the quality referred to in Section 8 herein and if the conditions specified in Article 9 are satisfied, we shall take back the flawed products and replace them with flawless products. In lieu of this, we may also reimburse the customer for the reduced value of the products caused by the flaws in question, it being understood that no further remedies shall be available to the customer in this case. If the replacement delivery twice fails to produce the desired results and after a reasonable period of grace designated in writing by the customer has expired, the customer may at its own discretion either demand a reduction in the price or rescind the contract. Any pure optical defects shall result in a right to reduction of value only.
3. Any Claim for damages regardless of the legal reason shall exist only in the event of wilful acts or gross negligence on our part. Claims for damages in accordance with the law as to liability for defective products (Product Liability Act), as well as the liability for injury to life, body and health and the liability for breach of substantial contractual duties shall not be affected hereby. The legal representatives and their agents shall be liable in relation to the Purchaser insofar as legal Claims can be made against such, but also only in the event of wilful acts or gross negligence. Unaffected hereby shall be the liability for injury to life, body and health as well as the liability for the breach of substantial contractual duties.
4. The above limitation of liability shall also not apply if we have accepted a guarantee for the quality of the goods.
5. The precondition for substitute performance shall be proof of correct handling in accordance with our Installation, Operation and care instructions as well as proper Processing.
6. We shall reimburse direct consequential damage up to a maximum limit of EUR 150,000 per case of damage. Any further Claims for damages (e.g. for loss of profit, loss of use etc.) are excluded.
7. The customer shall be obliged to check the goods for any Variation in colour pursuant to Section 9 herein. Once the goods have been used, we shall not be liable in any way for variations in colour.
8. Similarly, we shall not be liable for any of the consequences of improper planning or tiling work or for damage caused by inappropriate cleaning particularly involving detergents containing hydrofluoric acid.
9. We shall not accept any guarantee for products other than those classified as Grade I products, in other words for inferior qualities. This shall especially apply to reduced resistance to frost and acid as well as wear and tear and cracks in the glazing, etc.

STANDARD TERMS AND CONDITIONS OF SALE, DELIVERY AND PAYMENT

10. Any subsequent changes to the surface as a result of our products being refired, particularly the addition of decorations, shall be subject to our prior written approval.

Our contractual Partners similarly undertake to impose this Obligation on customers when reselling our products. We shall assume no guarantee for any products modified in the manner anticipated by this Provision.

11. Our liability for any flaws in our products shall expire after a period of two years commencing with delivery to the customer. If the customer is subject to any justified Claims within the period agreed upon between him and his own customers following the Utilisation of the tiles in a building, we shall waive the Statute of limitations for a period of five years commencing with delivery to our customer. If the customer informs us that his customer has asserted Claims against him within the aforementioned five-year period, we shall additionally waive the Statute of limitations for a period ending 14 days after the Claims against our customer have become legally binding. All liability for consequential loss or damage shall expire after five years exclusively pursuant to Section 634a of the German Civil Code.

§ 11 Copyrights

The illustrations, reports and data published by us are in most cases protected by Copyright. Any use of such materials which is not approved under the Copyright Act shall require our prior consent. This shall apply in particular in relation to copying, Processing, translation, storage of data, Processing or the reproduction of pictures, product forms or other documents.

§ 12 Retention of title

1. All goods shall remain our property (current account reservation) pending full discharge of all receivables, including the outstanding balance in connection with our business relations. This shall also apply to all current, future or contingent receivables. If we accept bills or cheques, our Claims shall not be deemed to have been discharged until the irrevocable payment of such bills or cheques.
2. As long as it is not in arrears of payment, the customer may resell the goods subject to our retention of title as part of its normal business operations only and with the care of a prudent businessman provided that it retains title with respect to the customer. The use of the goods subject to retention of title for the purpose of performing construction or delivery obligations shall also be deemed to constitute resale. Prior to effective payment, the customer may not dispose of the goods supplied by us in any other way; in particular, it shall not assign the goods supplied by us to third parties or pledge them as collateral.
3. If the customer resells, uses or processes the goods subject to retention of title or consolidates them with other goods, it shall assign to us the Claim arising from such resale, use, Processing or consolidation upon placing his Order for the goods with us. If the goods are resold together with other goods, the Claim arising from such resale shall be assigned to us in the ratio of the invoice value of the goods subject to retention of title relative to the invoice value of the other goods. The customer shall be entitled and obliged to collect Claims assigned to us. Apart from collection, it may not dispose of the Claims assigned to us in any other way without our prior written authorisation.

If the customer is in arrears of payment, the right of disposal and collection granted pursuant to Section 12 (2) and (3) above with respect to the goods supplied by us may be revoked at any time. Moreover, in this event we shall be entitled to withdraw from the agreement and to call upon the customer to surrender the goods supplied subject to the current account reservation clause as long as all Claims receivables have not been paid in full.

4. In this case, the customer shall at our request immediately refrain from any further transactions with respect to the goods supplied by us, safeguard them at its expense and inform the third-party debtors in question of the assignment of the receivable pursuant to Section 12, assist in recovering all receivables from such third-party debtors and furnish us with any information and documents required for that purpose. As soon as the customer is in arrears of payment, we may disclose the existence of such assignment to its customers. The cus-

tomers shall immediately inform us of any seizures or other Intervention on the part of third parties affecting the goods subject to retention of title.

5. If the value of the collateral provided exceeds the value of the receivables by more than 10%, we shall release the collateral at the customer's request.
6. The customer shall insure the goods delivered by us and subject to retention of title against fire and theft and on request to furnish us with evidence of the existence of such insurance.

§ 13 Offsetting, assignment

1. Counterclaims may be offset against our Claims receivables only provided that such counterclaims have been acknowledged by us or are legally binding.
2. Claims against us may not be assigned.

§ 14 Closing provisions (applicable law, disputes, severability)

1. The conclusion, content and interpretation of the contract as well as any additions to it shall be subject to the law of the Federal Republic of Germany, it being understood that the United Nations Convention on the International Sale of Goods (CISG) shall be excluded.
2. The place of fulfilment for both parties shall be our headquarters. Exclusive place of jurisdiction for all disputes in connection with our deliveries and Services as well as those arising out of the contract shall be Saarbrücken.
3. If any of the provisions contained in these Standard terms and conditions of business are or become void, the validity of the remaining provisions shall not be affected. In this case, the invalid provisions shall be replaced by provisions that approximate as closely as possible the commercial purpose of the invalid provisions in so far as there are no applicable statutory provisions.

SUCHVERZEICHNIS | INDEX

nach Artikel-Nummern | *Article number index*

Art.-Nr.	Seite Page
1048	43, 44
1049	44
1050	42
1051	42
1052	42, 43
1056	43
1070	79
1106	169, 170, 209
1171	209
1190	169, 170
1210	61
1212	61
1222	123, 124, 125
1240	143, 144, 145, 208
1241	218
1260	25, 88, 89, 111, 169, 170, 207, 208
1261	88
1310	33, 79, 88
1312	96
1313	96
1315	209
1320	208
1321	126
1323	76
1330	209
1333	20, 132
1346	111
1361	88
1390	127, 208
1391	128
1425	125
1426	125
1427	125
1428	125
1440	38, 47, 54, 65, 104, 118, 119, 123, 128
1451	47
1486	128
1511	42
1516	41
1538	109
1539	109
1550	47
1555	169, 170
1560	127, 208

Art.-Nr.	Seite Page
1571	25, 35, 84, 94, 95, 126, 127, 158, 207
1572	127
1574	95
1581	20, 27, 33, 46, 47, 55, 65, 89, 104, 105, 119, 128, 132
1582	96, 97
1583	96, 97
1586	127
1590	218
1597	128
1599	218
1600	218
1660	111
1670	122
1701	43
2001	211
2003	211
2004	213
2005	40, 45, 126
2006	45
2007	210
2008	212
2009	213
2010	210
2011	211, 212
2012	203
2013	24, 32, 37, 38, 60, 75, 92, 110, 122, 129, 137, 142, 155, 156, 197
2014	180
2015	40
2016	82, 83
2019	45
2020	211
2024	59, 60, 66
2025	45
2027	46
2030	28, 49, 66, 72, 78, 83, 108
2031	94
2037	34, 35
2039	26
2041	71
2043	71

Art.-Nr.	Seite Page
2044	71
2045	71
2052	122
2071	129
2072	177, 181, 207, 213
2073	177, 181, 207, 213
2074	177, 181, 207, 213
2078	28
2079	27
2085	26, 93
2114	112
2118	180, 210
2119	179, 212
2120	179, 212
2121	179, 211
2122	179, 211
2125	211
2127	211
2135	75, 137, 155
2137	37
2139	76, 78
2158	112
2184	31
2190	113
2200	176, 179, 206, 212
2205	176
2213	177, 180
2214	180
2215	179
2216	210
2218	180
2219	179, 212
2225	181
2226	181
2231	180
2232	181
2247	177
2248	177, 206
2253	180
2263	181
2265	213
2266	213
2269	213
2310	158, 201, 202
2336	72

Art.-Nr.	Seite Page
2337	72
2341	143
2343	204
2349	25, 93, 221, 222
2350	199, 200
2351	223
2352	223
2353	223
2354	224
2356	56, 65, 91, 220, 221
2357	219
2358	221
2359	224
2360	87, 157, 214, 215
2361	86, 214
2362	225
2363	215, 216
2364	112
2365	109
2366	112
2369	215
2376	90
2377	90, 91
2379	91, 92
2392	28, 222, 223
2394	23, 28, 59, 66, 107, 121, 122
2405	177
2409	28
2410	29
2411	29
2417	202
2419	155
2421	94
2493	137, 156, 203, 225
2495	181, 207
2496	34
2521	202
2525	155
2526	135, 154
2536	135
2570	33
2572	33, 34
2575	154, 155
2576	135, 153, 154

SUCHVERZEICHNIS | INDEX

nach Artikel-Nummern | *Article number index*

Art.-Nr.	Seite Page
2577	134, 152, 153
2578	202
2600	180
2607	178, 181
2609	178, 181
2617	136, 197
2620	197
2621	202
2628	136
2632	31, 80, 81
2640	61
2641	62
2642	62, 63
2643	62
2644	62
2645	63
2646	63
2647	63
2649	64
2650	29, 63, 64
2652	93
2656	24
2658	41
2660	23, 24, 27, 28, 37, 39, 45, 58, 59, 66, 70, 106, 107, 121, 126, 141
2670	109
2679	48
2680	66, 215, 223
2682	113
2685	135, 159, 202
2691	39
2697	39
2702	176
2706	27, 143, 157, 176, 179, 207, 216, 217, 218
2717	92, 108, 122
2730	36, 39, 44, 56, 70, 138
2731	178
2732	134, 139, 152, 196, 201
2733	26, 37, 86, 107, 121, 158
2735	90
2736	29, 80
2737	198, 199

Art.-Nr.	Seite Page
2751	194
2752	195
2753	196, 197
2754	197
2756	40
2757	98
2759	104
2761	36
2765	178
2772	178
2776	48
2792	74, 77, 78
2793	73, 74, 76, 77
2794	40
2795	138
2802	243
2803	234
2806	243
2807	234
2810	21, 22, 57, 58, 105, 106, 120, 139, 140
2816	242
2821	245
2834	30, 81, 82
2835	84, 85
2852	155
2854	203
2863	238
2867	235
2869	240
2870	37, 129
2871	36, 37, 129
2872	24, 28, 29, 35, 46, 60, 64, 66, 72, 92, 108, 122, 129, 156
2873	217
2874	217
2875	32, 38, 49, 83, 110, 142
2877	99
2882	236
2888	246
2891	237
2896	244
2919	108
2938	244

Art.-Nr.	Seite Page
2960	53, 103, 117, 149
2961	52, 69, 102, 116, 148
2962	50, 51, 67, 68, 100, 101, 114, 115, 146, 147
2969	241
2980	238, 239
2987	150
2988	133, 150, 151, 152
3007	173
3009	173
3010	182
3011	182
3012	182
3013	182
3014	182
3015	182
3016	182
3017	182
3018	182
3019	183
3020	182
3021	182
3022	182
3050	183
3051	183
3052	183
3053	183
3054	183
3055	184
3056	191
3103	204
3105	204
3107	172, 173
3120	190
3121	190
3122	190
3123	190
3124	190
3125	190
3126	190
3130	204
3135	204
3161	190
3162	190
3163	190

Art.-Nr.	Seite Page
3164	190
3165	190
3171	204
3177	204
3201	171, 205
3213	172
3214	172
3215	172, 204, 205
3242	206
3244	205
3245	171, 172, 205, 206
3246	172
3293	173, 206
3294	173
3295	173, 206
3296	173, 206
3297	173
3350	172, 205
3450	206
3540	187
3542	187
3544	187
3545	187
3570	174
3571	174
3572	174
3573	174
3574	174
3575	174
3576	174
3577	174
3578	174
3585	175
3586	175
3587	174
3588	174
3589	174
3592	175
3593	175
3594	175
3600	183
3601	183
3602	183
3604	183
3605	183

SUCHVERZEICHNIS | INDEX

nach Artikel-Nummern | *Article number index*

Art.-Nr.	Seite Page
3620	189
3621	189
3622	189
3624	189
3626	189
3630	187
3631	187
3632	187
3634	187
3635	187
3650	188
3652	188
3654	188
3655	188
3660	188
3661	188
3662	188
3664	188
3665	188
3670	186
3671	186
3672	186
3674	186
3675	186
3680	185
3681	185
3682	185
3684	185
3685	185
3690	184
3691	184
3692	184
3694	184
3695	184
3709	171, 206
3753	171
3952	189
3962	189
3963	189
3972	189

SUCHVERZEICHNIS | INDEX

nach Farb-Nummern | *Colour number index*

Farb-Nr. Colour-Nr.	Seite Page
AJ10	47, 48, 49
AJ20	48, 49
AJ60	47, 48, 49
AJ90	48, 49
AL00	20
AL10	20, 21, 23, 24
AL40	20, 22, 23, 24
AL60	21, 22, 23, 24
AL65	24
AL69	24
AL70	20, 21, 23, 24
AL75	24
AL79	24
AL80	20, 22, 23, 24
AL90	21, 22, 23, 24
BC00	128
BC30	129
BM00	54, 55
BM02	54, 55
BM06	52, 53, 56, 57, 58, 59, 60
BM09	50
BM10	56, 57, 58, 59, 60
BM20	54, 55
BM22	54, 55
BM40	52, 53, 56, 57, 58, 59, 60
BM49	51
BM60	52, 53, 54, 55, 56, 58, 59, 60
BM61	56, 58, 59, 60
BM62	54, 55
BM65	56
BM68	51
BM70	52, 53, 56, 57, 58, 59, 60
BM79	50
BM90	54, 55
BM92	54, 55
BP20	143
BP60	143
BP70	143
BP90	143
BR60	80, 81, 83
BR65	80, 82
BR80	80, 81, 83

Farb-Nr. Colour-Nr.	Seite Page
BR85	80, 82, 83
BR90	80, 81, 83
BR95	81, 82, 83
BT01	25, 84
BT02	25
BT10	25, 26, 27
BT20	25, 26, 27
BT21	25, 84
BT22	25
BT60	25, 26, 27
BT90	25, 26, 27
BU00	33
BU0M	33, 34, 35
BU1M	33, 34, 35, 234
BU2M	33, 34, 35, 234
BU7M	33, 34, 35, 234
BU9M	33, 34, 35
BZ06	84, 86, 87
BZ10	84, 86, 87
BZ40	85, 86, 87
BZ60	85, 86, 87
BZ65	87
BZ69	85, 86
BZ70	84, 86, 87
BZ75	87
BZ79	85, 86
C000	169
C010	169
C011	169
C032	169
C034	169
C041	169
C053	169
C060	169
C061	169
C070	169
C071	169
C072	169
C090	169
C091	169
C100	170
C110	170
C111	170
C122	170
C125	170

Farb-Nr. Colour-Nr.	Seite Page
C127	170
C130	170
C132	170
C134	170
C138	170
C139	170
C141	170
C145	169
C149	169
C150	169
C152	169
C153	169
C154	169
C160	170
C161	170
C170	170
C171	170
C172	170
C190	170
C191	170
C211	176, 177, 178
C221	176, 177
C227	176, 177
C240	176, 177
C244	176, 177
C245	176, 177
C255	176, 177
C260	176, 177, 178
C261	176, 177
C264	176, 177
C265	176, 177
C266	176, 177
C270	176, 177
C271	176, 177
C272	176, 177
C281	176, 177
C290	176, 177, 178
C291	176, 177
C300	171, 172, 173, 174, 175, 182, 183, 184, 185, 186, 187, 188, 189, 190
C304	182, 183
C305	182, 183
C306	182, 183
C307	182, 183

Farb-Nr. Colour-Nr.	Seite Page
C310	171, 172
C311	171, 172, 189, 190
C320	171, 172, 173
C321	171
C322	171
C325	171
C327	171
C330	171
C331	171
C332	171
C333	171
C334	171
C335	171, 172, 173
C338	171
C339	171
C340	171
C341	171
C342	171
C344	171, 172, 182, 183, 184, 185, 186, 187, 188
C345	171
C349	171, 172, 173, 183, 184, 185, 186, 187, 188
C350	171
C351	171
C352	171, 172, 173
C353	171
C354	171
C355	171, 172, 173
C360	171, 172, 173, 174, 175, 189, 190
C361	171, 172
C362	171
C363	171
C364	171
C365	171
C366	171
C370	171, 172
C371	171, 172
C372	171, 172
C390	171, 172, 183, 184, 185, 186, 187, 188, 189, 190
C391	171, 172

SUCHVERZEICHNIS | INDEX

nach Farb-Nummern | *Colour number index*

Farb-Nr. Colour-Nr.	Seite Page
C3MD	191
C3WS	191
C411	179, 180, 181
C460	179, 180, 181
C461	179, 181
C464	179, 181
C465	179, 181
C466	179, 181
C471	179, 180, 181
C472	179, 181
C490	179, 180, 181
C491	179, 180, 181
C901	189
C902	189
C903	189
C904	189
CB00	89, 90
CB05	89, 90
CB10	89, 90, 91, 92
CB15	90
CB60	90, 91, 92
CB65	90, 91
CB70	89, 90, 91, 92
CB75	90
CB90	90, 91, 92
CG10	94, 95
CG11	95
CG30	94, 95
CG31	95
CG40	94, 95
CG41	95
CG50	95
CG51	95
CG60	94, 95
CG61	95
CJ10	158, 159
CJ20	158, 159
CJ60	158, 159
CJ61	158, 159
CJ62	158, 159
CM00	104
CM01	104
CM02	104
CM03	104
CM05	108

Farb-Nr. Colour-Nr.	Seite Page
CM0L	106, 107
CM0M	100, 102, 103, 105, 106, 107, 108
CM30	104
CM60	104, 105
CM61	105
CM62	105
CM63	105
CM65	108
CM6L	106, 107
CM6M	101, 102, 103, 106, 107, 108
CM75	108
CM7L	106, 107
CM7M	100, 102, 103, 105, 106, 107, 108
CM95	108
CM9L	106, 107
CM9M	101, 102, 103, 106, 107, 108
CT10	214, 215, 216, 217, 218
CT60	214, 215, 216, 217, 218
CT61	214, 215, 216, 217
CT62	214, 215, 216, 217
CT66	218
CT70	214, 215, 216, 217
CT77	218
CT80	214, 215, 216, 217
DM20	29, 30, 31, 32
DM60	29, 30, 31, 32
DM70	29, 30, 31, 32
DM90	29, 30, 31, 32
DS00	96
DS10	96
DS20	97
DS30	97
DS40	97
DS50	97
EF00	143
EF01	143
EF10	144
EF11	144
EF20	144
EF21	144

Farb-Nr. Colour-Nr.	Seite Page
EF30	145
EF31	145
EF40	145
EF41	145
EF50	144
EF51	144
EF62	143
EF63	143
EF64	144
EF65	144
EF70	144
EF71	144
EF90	144
EF91	144
GK10	210
GK20	210
GK30	210
GK50	210
GS06	240
GS20	240
GS60	240, 241
GS90	240, 241
GT10	210, 211, 212, 213
GT20	210, 211, 212, 213
GT22	211, 213
GT30	210, 211, 212, 213
GT50	210, 211, 212, 213
HE00	76
HE10	76, 77, 78
HE20	76, 77, 78
HE30	77, 78
HE80	77, 78
HE99	78
HR00	73, 74, 75, 76
HR10	73, 74, 75, 76
HR20	73, 74, 75, 76, 245
HR30	73, 74, 75, 76, 245
HR80	74, 75, 76
IA00	79
IA01	79
IA03	79
IA11	79
IA12	79
IA31	79
IA32	79

Farb-Nr. Colour-Nr.	Seite Page
LC00	111
LC10	111
LC11	111
LC15	112
LC60	111
LC61	111
LC65	112
LC91	111
LC95	112
LI00	122
LI01	122
LO10	157
LO20	157
LO60	157
LO61	157
LO70	157
LO90	157
LS06	36, 37, 38
LS60	36, 37, 38, 235, 236
LS65	36
LS70	36, 37, 38, 235, 236
LS90	36, 37, 38, 235, 236
LY00	65
LY10	65
LY20	65, 66
LY60	65, 66
MA00	38
MA01	38
MA0P	39, 40
MA20	38
MA21	38
MA2P	39, 40
MA62	39
MA66	39
MA80	40, 41
MA90	40, 41
MK00	123
MK0A	123
MK0B	124
MK0C	123
MK0D	124
MK0E	123
MK0F	124
MK0G	124
MK0H	124

SUCHVERZEICHNIS | INDEX

nach Farb-Nummern | *Colour number index*

Farb-Nr. Colour-Nr.	Seite Page
MK0I	124
MK0J	124
MK0K	124
MK0L	125
MK0M	125
MK1P	126
MK90	123
MK9E	123
MK9F	124
MK9I	124
MK9J	124
MK9K	124
MK9M	125
MK9P	126
MKB1	125
MKB2	125
MKB3	125
MKB4	125
MKB5	125
MKE1	125
MKE2	125
MKE3	125
MKE4	125
MKE5	125
MR00	41, 42, 43
MR02	43
MR06	43, 44
MR09	43
MR0M	44, 45, 46
MR0P	44, 45, 46
MR22	46
MR60	41, 42, 43
MR62	43
MR66	44, 46
MR6M	44, 45, 46
MR6P	44, 45, 46
MR90	41, 42, 43
MR92	44
MR96	44
MR9M	44, 45, 46
MR9P	44, 45, 46
MT06	237, 238
MT60	237, 238, 239
MT70	237, 238, 239
MW00	61

Farb-Nr. Colour-Nr.	Seite Page
MW10	61
MW90	61
NW00	46
NW01	46
NW02	46
NW03	46
PC10	198, 199, 201, 202, 203
PC60	198, 199, 201, 202, 203
PC61	198, 199, 201, 202, 203
PC62	198, 199, 201, 202, 203
PC70	198, 199, 201, 202, 203
PS10	198, 199, 201, 202, 203
PS60	198, 200, 201, 202, 203
PS61	199, 200, 201, 202, 203
PS62	199, 200, 201, 202, 203
PS70	198, 200, 201, 202, 203
RA00	35
RA10	35
RD60	72
RD70	72
RD90	72
RT2M	28, 29
RU10	61, 62, 63, 64, 242, 243
RU20	61, 62, 63, 64, 243
RU60	61, 62, 63, 64, 242, 243, 244
RU90	61, 62, 63, 64, 242, 243, 244
SA10	109
SA20	109, 110
SA60	109, 110
SA61	109, 110
SA80	109, 110
SB00	132
SB10	132, 133, 134, 135, 136, 137

Farb-Nr. Colour-Nr.	Seite Page
SB1M	135, 136
SB1R	135, 136
SB1V	135, 136
SB60	132, 133, 134, 135, 136, 137
SB6M	135, 136
SB6R	135, 136
SB6V	135, 136
SB70	132, 133, 134, 135, 136, 137
SB7M	135, 136
SB7R	135, 136
SB7V	135, 136
SB90	132, 133, 135, 136, 137
SB9M	135, 136
SB9R	135, 136
SB9V	135, 136
SD1B	146, 148, 149, 150, 152, 153, 155, 156
SD1L	153
SD1M	153, 154
SD1R	154, 155
SD2B	146, 148, 149, 150, 151, 152, 153, 155, 156
SD2L	153
SD2M	153, 154
SD2R	154, 155
SD5B	150, 151, 152, 153, 155, 156
SD5L	153
SD5M	153, 154
SD5R	154, 155
SD6B	150, 152, 153, 155, 156
SD6L	153
SD6M	153, 154
SD6R	154, 155
SD7B	147, 148, 149, 150, 151, 152, 153, 155, 156
SD7L	153
SD7M	153, 154
SD7R	154, 155
SD8B	150, 152, 153, 155,

Farb-Nr. Colour-Nr.	Seite Page
	156
SD8L	153
SD8M	153, 154, 155
SD8R	154, 155
SD9B	147, 148, 149, 150, 151, 152, 153, 155, 156
SD9L	153
SD9M	153, 154
SD9R	154, 155
SJ10	88, 89
SJ70	88, 89
SJ90	88, 89
SN20	138
SN60	138, 139, 140, 141, 142
SN61	138, 139, 140, 141, 142
SN62	138, 139, 140, 141, 142
SN70	138, 139, 141, 142
SN71	138, 139, 140, 141, 142
SN72	138, 139, 140, 141, 142
SN80	138
SW00	126, 127
SW01	126, 127
SW02	127, 128
SW10	127
SW11	127
SW12	127
SZ00	93, 94
SZ10	93, 94
SZ60	93, 94
SZ90	93, 94
TC00	118, 119
TC01	118
TC05	119
TC10	114, 116, 117, 120, 121, 122
TC20	118, 119
TC21	118
TC25	119
TC50	118, 119
TC60	114, 115, 116, 117,

SUCHVERZEICHNIS | INDEX

nach Farb-Nummern | *Colour number index*

Farb-Nr. <i>Colour-Nr.</i>	Seite <i>Page</i>	Farb-Nr. <i>Colour-Nr.</i>	Seite <i>Page</i>
	120, 121, 122, 246		223, 224, 225
TC70	114, 115, 116, 117, 120, 121, 122, 246	ZM20	219, 220, 221, 222, 223, 224, 225
TC90	115, 116, 117, 120, 121, 122, 246	ZM60	219, 220, 221, 222, 223, 224, 225
TC99	122	ZM70	219, 220, 221, 222, 223, 224, 225
TE60	98, 99	ZM90	219, 220, 221, 222, 223, 224, 225
TE61	98, 99	ZM91	219, 221, 222, 223, 224, 225
TE70	98, 99	ZN1L	70
TE90	98, 99	ZN1P	67, 69, 70, 71
TM01	27	ZN2L	70
TM60	27, 28	ZN2P	67, 69, 70, 71
TM6L	27, 28	ZN8P	71
TM6M	27, 28	ZN9L	70
TW01	207, 208, 209	ZN9P	68, 69, 70, 71
TW02	207, 208, 209		
TW03	208, 209		
TW04	208, 209		
UA00	113		
UA20	113		
UA30	113		
UA40	113		
UA50	113		
UA70	113		
UL10	194, 195, 196, 197		
UL60	194, 195, 196, 197		
UL61	194, 195, 196, 197		
UL62	194, 195, 196, 197		
UL70	194, 195, 196, 197		
UL72	194, 195, 196, 197		
UL80	194, 195, 196, 197		
UL90	194, 195, 196, 197		
UT01	204, 205, 206		
UT02	204, 205, 206		
UT03	204, 205		
UT21	205		
UT22	205		
UT41	206, 207		
UT42	206, 207		
WE00	111		
WZ10	244		
WZ20	244		
WZ80	244		
ZM00	219, 220, 221, 223, 224, 225		
ZM10	219, 220, 221, 222,		















NOTIZEN | NOTES

NOTIZEN | NOTES

ZEICHENSCHLÜSSEL | SIGNS AND SYMBOLS

1 2 3 4 5 Abriebgruppe nach DIN EN ISO 10545-7.

Die Abriebgruppe beschreibt die Verschleißeigenschaft von Fliesen aus glasiertem Steinzeug. Es werden 5 Abriebgruppen unterschieden: von 1 (sehr leichte Beanspruchung) bis 5 (starke Beanspruchung).

-  Rutschhemmung im gewerblichen Bereich
-  Rutschhemmung im Barfußbereich
-  Edelmetallaufgabe. Kratzempfindliches Dekor.
Reinigung nur mit Wasser und Geschirrspülmittel.
Verfugung nur mit quarzmehlfreien Fugenfüllern.
-  Glasauflage, Craquelébildung möglich
(feine Haarrisse in der Glasur)
-  Eine glasierte Kante
-  Eine glasierte Längskante
-  Eine glasierte Kurzkante
-  Frostbeständig nach DIN EN 10545-12
-  Rektifiziert
-  Musterabgabe nur gegen Berechnung
-  Nur auftragsbezogene Fertigung, kein Lagerartikel.
Storno nicht möglich.
-  Passende Bodenfliesen
-  Fliesenstärke 6 mm
-  Fliesenstärke 20 mm

CeramicPlus Reinigungsfreundliche Oberflächenveredelung

VilbostonePlus Ausrüstung zur Reduktion der Fleck- und Schmutzempfindlichkeit

VilboTouch Microfeine rutschhemmende Oberfläche















PowderTouch Matte, pudrige Premiumglasur

Concept³ Komplettes Wand- und Bodenkonzept

 1  2  3  4 Variationsvielfalt

1 2 3 4 5 Wear-resistance group (DIN EN ISO 10545-7)

The wear-resistance group defines the wearing properties of tiles in glazed vitreous. A distinction is made between 5 wear-resistance groups, from 1 (suitable for minimal stress) to 5 (suitable for high levels).

-  Anti-slip in workshop areas.
-  Anti-slip in barefoot areas.
-  Precious metal-plated. Not scratchproof.
Clean with water or dish washing liquid only.
Jointing with quartzpowderfree material only.
-  Glass-plated. Hairline cracks in the glaze may develop.
-  One glazed edge
-  One glazed long edge
-  One glazed short edge
-  Frostproof in acc. with DIN EN 10545-12
-  Rectified
-  Sample tiles available for a charge
-  Produced to order only, not stocked as standard.
Cancellation not possible.
-  Recommended floor tiles
-  Tile thickness 6 mm
-  Tile thickness 20 mm

CeramicPlus Easy-care surface finish

VilbostonePlus Reduces susceptibility to staining and soiling

VilboTouch Micro-fine slip-resistant surface finish

PowderTouch Matt, powdery premium glaze

Concept³ Complete wall and floor concept

 1  2  3  4 Shade variation

V & B Fliesen GmbH

Rotensteiner Weg
D-66663 Merzig
E-Mail: info@vb-fliesen.com



Unsere Fliesen sind mit dem EPD-Label des IBU (Institut für Bauen und Umwelt e.V.) ausgezeichnet. Diese Zertifizierung ermöglicht Architekten und Planungsbüros unsere Produkte in allen Objekten einzusetzen, die nach BREEAM, LEED, DGNB oder vergleichbaren internationalen Deklarationen für nachhaltiges Bauen eingestuft sind.

Our tiles have been awarded the Environmental Product Declaration (EPD) label by the IBU (Institut für Bauen und Umwelt e.V.). This certification allows architects and planners to utilise our products in all properties that have been certified as satisfying the BREEAM, LEED, DGNB or other comparable international requirements for sustainable building.



Weitere Inspirationen:
Scannen Sie einfach diesen
Code mit Ihrem Smartphone



*More inspiration:
Simply scan this code with
your smartphone*



EXP - 04/23 Farb- und Dimensionsabweichungen entsprechen den üblichen Toleranzen. Sortiments-, Modell- und Farbänderungen vorbehalten.
Shades and dimensions subject to the usual tolerances. We reserve the right to make technical modifications to the range and alter colours.



Villeroy & Boch
1748